

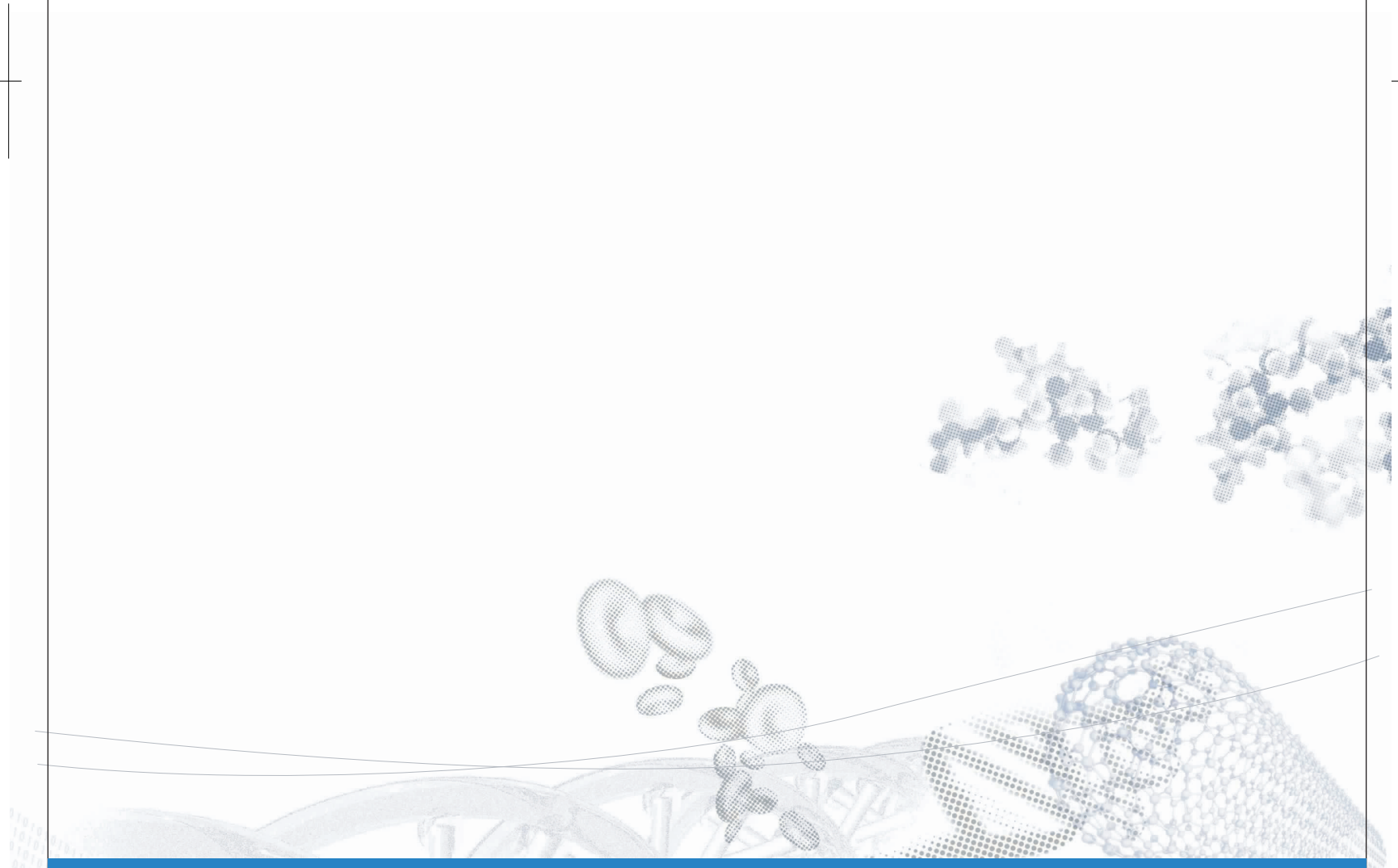

# FluoroMax Plus & FluoroMax Plus-P

Operation Manual  
Part number 570002851 rev. A





# FluoroMax<sup>®</sup> Plus & FluoroMax<sup>®</sup> Plus-P

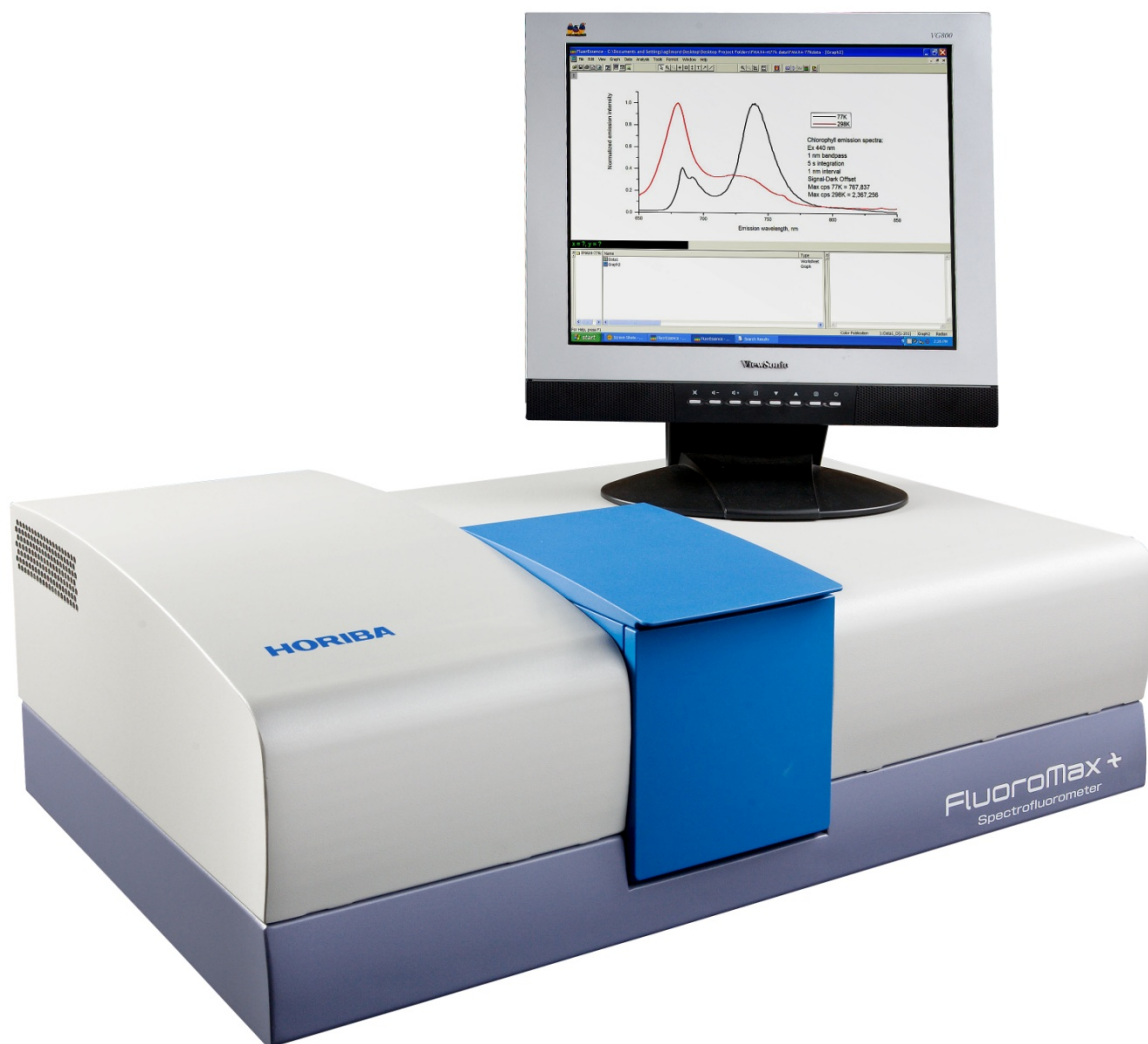

Operation Manual

<http://www.HORIBA.com>

Rev. A



**HORIBA**  
Scientific

Copyright © 2015 by HORIBA Instruments Incorporated. All rights reserved. No part of this work may be reproduced, stored, in a retrieval system, or transmitted in any form by any means, including electronic or mechanical, photocopying and recording, without prior written permission from HORIBA Instruments Incorporated. Requests for permission should be requested in writing. Origin<sup>®</sup> is a registered trademark of OriginLab Corporation. Alconox<sup>®</sup> is a registered trademark of Alconox, Inc. Ludox<sup>®</sup> is a registered trademark of W.R. Grace and Co. Teflon<sup>®</sup> is a registered trademark of E.I. du Pont de Nemours and Company. Windows<sup>®</sup> is a trademark of Microsoft Corporation. Uniblitz<sup>®</sup> is a registered trademark of VA, Inc.

Information in this manual is subject to change without notice, and does not represent a commitment on the part of the vendor.

October 2015

Part Number 5700002851

# Table of Contents

<b>0: Introduction .....</b>	<b>0-1</b>
About the FluoroMax <sup>®</sup> Plus and FluoroMax <sup>®</sup> Plus-P .....	0-1
Chapter overview .....	0-2
Disclaimer.....	0-3
Safety summary .....	0-5
Risks of ultraviolet exposure .....	0-7
Additional risks of xenon lamps.....	0-9
CE compliance statement .....	0-12
RoHS Declaration of Conformity .....	0-13
WEEE .....	0-14
<b>1: Requirements &amp; Installation .....</b>	<b>1-1</b>
Safety-training requirements.....	1-1
Surface requirements.....	1-2
Environmental requirements .....	1-3
Electrical requirements.....	1-4
Unpacking and Installation .....	1-5
Software emulation .....	1-9
<b>2: System Description .....</b>	<b>2-1</b>
Introduction.....	2-1
Basic theory of operation .....	2-1
Optical layout.....	2-2
<b>3: System Operation.....</b>	<b>3-1</b>
Introduction.....	3-1
Power switch .....	3-1
Turning on the system.....	3-2
Checking system performance.....	3-3
<b>4: Data Acquisition .....</b>	<b>4-1</b>
Introduction to FluorEssence <sup>™</sup> and Multigroup.....	4-1
Experiment Menu button .....	4-2
Previous Experiment Setup button .....	4-4
Auto Run Previous Experiment button.....	4-5
Make Overlay File button .....	4-6
3D Scan to 3D Profile button.....	4-7
Run JY Batch Experiments button .....	4-9
Real Time Control .....	4-11
Create/Use Calibration Curve from CWA Data.....	4-12
2D Intensity Map .....	4-16
Launch DataStation.....	4-18
Switch menu between HJY Software Application and Origin Std. ....	4-19
Multigroup.....	4-20
Running an unknown sample.....	4-23
Using corrected signals in FluorEssence <sup>™</sup> .....	4-28
<b>5: Optimizing Data .....</b>	<b>5-1</b>
Cuvette preparation.....	5-1

Sample preparation .....	5-2
Running a scan on a sample.....	5-4
Measuring the G factor.....	5-5
Improving the signal-to-noise ratio .....	5-7
Correcting data.....	5-14
<b>6: Maintenance .....</b>	<b>6-1</b>
Introduction.....	6-1
Lamp replacement .....	6-1
Electronics.....	6-11
Updating the FluoroMax <sup>®</sup> Plus firmware .....	6-13
<b>7: Troubleshooting .....</b>	<b>7-1</b>
Chart.....	7-1
Using diagnostic spectra .....	7-4
Further assistance... ..	7-9
<b>8: Producing Correction Factors .....</b>	<b>8-1</b>
Introduction.....	8-1
Generating emission correction factors .....	8-2
Calculating emission correction factors .....	8-3
Using correction-factor files.....	8-10
Excitation correction factors .....	8-13
<b>9: FluoroMax<sup>®</sup> Plus-P Phosphorimeter Operation .....</b>	<b>9-1</b>
Introduction.....	9-1
Theory of operation .....	9-2
Applications for the phosphorimeter .....	9-5
Operation of the phosphorimeter .....	9-8
Processing phosphorimeter data .....	9-10
Lamp replacement .....	9-11
<b>10: Automated Polarizers .....</b>	<b>10-1</b>
Introduction.....	10-1
Installation .....	10-5
Alignment .....	10-6
Using automated polarizers .....	10-13
Maintenance.....	10-18
Troubleshooting .....	10-19
<b>11: Technical Specifications .....</b>	<b>11-1</b>
Introduction.....	11-1
Spectrofluorometer system .....	11-2
Minimum host-computer requirements .....	11-4
Software .....	11-4
<b>12: Components &amp; Accessories .....</b>	<b>12-1</b>
Itemized list of FluoroMax <sup>®</sup> Plus accessories .....	12-2
FL-1013 Liquid Nitrogen Dewar Assembly .....	12-3
Sample cells.....	12-4
F-3026 Correction Factor Kit.....	12-6
F-3023 Janis cryostat.....	12-7
F4-3000 Fiber Optic Mount and 1950 Fiber Optic Bundles .....	12-8
1939 Cut-On Filter.....	12-9
FM-2008 Cut-On Filter Holder.....	12-10
FL4-1011 Four-Position Thermostatted Cell Holder .....	12-11
FL4-1012 Dual-Position Thermostatted Cell Holder .....	12-13
FL4-1027 Single-Position Thermostatted Cell Holder .....	12-15

J1933 Solid Sample Holder.....	12-17
F-3005/6 Autotitration Injector.....	12-19
1905-OFR 150-W Xenon Lamp .....	12-20
F-3004 Sample Heater/Cooler Peltier Thermocouple Drive .....	12-21
MicroMax 384 Microwell Plate Reader .....	12-22
FM4-2000 L-Format Polarizer .....	12-23
FL4-1015 Injector Port .....	12-24
F-3029 Quanta-φ accessory .....	12-25
FM-2002 Shutter accessory .....	12-26
F-3025 Stopped-flow accessory .....	12-27
FM4-2015 and FM4-2016 TCSPC upgrade.....	12-28
F4-3030 Temperature Bath.....	12-29
F-3031 Transmission Accessory.....	12-30
J400981 Trigger Cable.....	12-31
FM-2007 Windows for the FluoroMax <sup>®</sup> Plus sample compartment .....	12-32
<b>13: Glossary .....</b>	<b>13-1</b>
<b>14: Bibliography.....</b>	<b>14-1</b>
<b>15: Compliance Information .....</b>	<b>15-1</b>
Declaration of Conformity.....	15-1
Supplementary Information .....	15-1
<b>16: Index .....</b>	<b>16-1</b>





# 0 : Introduction

## About the FluoroMax<sup>®</sup> Plus and FluoroMax<sup>®</sup> Plus-P

Both the FluoroMax<sup>®</sup> Plus and FluoroMax<sup>®</sup> Plus-P are self-contained, fully automated spectrofluorometer systems. Data output is viewed on a PC, while printouts may be obtained via an optional plotter or printer. Unlike our standard FluoroMax<sup>®</sup>-4, the FluoroMax<sup>®</sup> Plus series includes a second detector to extend your working wavelength range or speed. Aside from this difference

in hardware, the operation of the FluoroMax<sup>®</sup> Plus is identical to the FluoroMax<sup>®</sup>-4. All FluoroMax<sup>®</sup> Plus and FluoroMax<sup>®</sup> Plus-P functions are under the control of FluorEssence<sup>™</sup> spectroscopy software. The main parts of the FluoroMax<sup>®</sup> Plus and FluoroMax<sup>®</sup> Plus-P spectrofluorometer systems are:

- State-of-the-art optical components
- A personal computer
- FluorEssence<sup>™</sup> for Windows<sup>®</sup>, the driving software.

The difference between the FluoroMax<sup>®</sup> Plus and FluoroMax<sup>®</sup> Plus-P is that the FluoroMax<sup>®</sup> Plus-P contains a phosphorimeter for phosphorescence measurements. This manual explains how to operate and maintain a FluoroMax<sup>®</sup> Plus series spectrofluorometer. The manual also describes measurements and tests essential to obtain accurate data. For a complete discussion of the almost limitless power provided by FluorEssence<sup>™</sup>, refer to the *FluorEssence<sup>™</sup> User's Guide* (especially regarding software installation) and the on-line help for Origin<sup>®</sup> and FluorEssence<sup>™</sup>, which accompany the system.

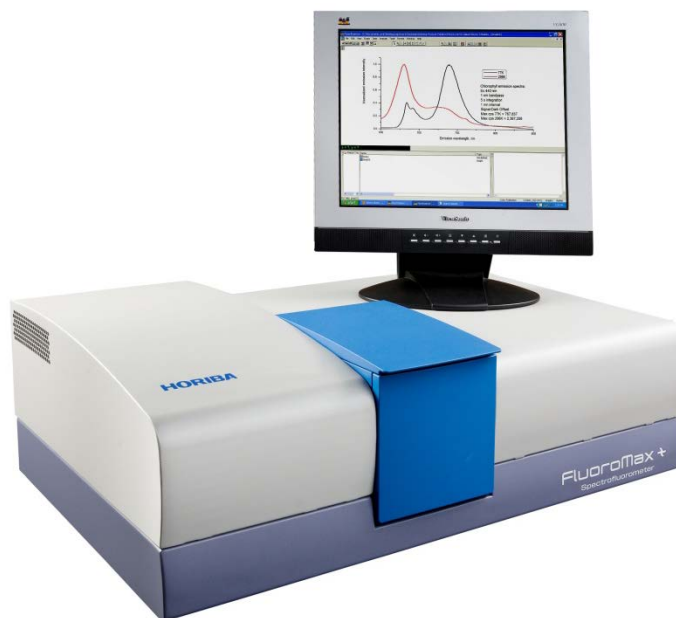

**Note:** Keep this and the other reference manuals near the system.

# Chapter overview

1: Requirements & Installation	Power and environmental requirements; select the best spot for the instrument.
2: System Description	How the FluoroMax <sup>®</sup> Plus and Plus-P work.
3: System Operation	Operation of the spectrofluorometer system, and calibration instructions.
4: Data Acquisition	How to use the special FluorEssence <sup>™</sup> buttons to acquire and plot data; how to determine peaks in an unknown sample.
5: Optimizing Data	Hints for improving the signal-to-noise ratio, instructions for obtaining corrected data, and other information useful for optimizing data and ensuring reproducibility.
6: Maintenance	Routine maintenance procedures such as replacing the lamp.
7: Troubleshooting	Potential sources of problems, their most probable causes, and possible solutions.
8: Producing Correction Factors	How to correct for variation in the system's sensitivity across the spectral range.
9: FluoroMax <sup>®</sup> Plus-P Phosphorimeter Operation	Theory, operation, applications, and troubleshooting of the optional phosphorimeter, available only on the FluoroMax <sup>®</sup> Plus-P system.
10: Automated Polarizers	Installation, operation, and troubleshooting of the optional automated polarizers.
11: Technical Specifications	Instrument specifications and computer requirements.
12: Components & Accessories	Accessories available for the FluoroMax <sup>®</sup> Plus, and how to use them.
13: Glossary	Some useful technical terms related to fluorescence spectroscopy.
14: Bibliography	Other important sources of information.
15: Declaration of Conformity	
16: Index	

# Disclaimer

By setting up or starting to use any HORIBA Instruments Incorporated product, you are accepting the following terms:

You are responsible for understanding the information contained in this document. You should not rely on this information as absolute or all-encompassing; there may be local issues (in your environment) not addressed in this document that you may need to address, and there may be issues or procedures discussed that may not apply to your situation.

If you do not follow the instructions or procedures contained in this document, you are responsible for yourself and your actions and all resulting consequences. If you rely on the information contained in this document, you are responsible for:

- Adhering to safety procedures
- Following all precautions
- Referring to additional safety documentation, such as Material Safety Data Sheets (MSDS), when advised

As a condition of purchase, you agree to use safe operating procedures in the use of all products supplied by HORIBA Instruments Incorporated, including those specified in the MSDS provided with any chemicals and all warning and cautionary notices, and to use all safety devices and guards when operating equipment. You agree to indemnify and hold HORIBA Instruments Incorporated harmless from any liability or obligation arising from your use or misuse of any such products, including, without limitation, to persons injured directly or indirectly in connection with your use or operation of the products. The foregoing indemnification shall in no event be deemed to have expanded HORIBA Instruments Incorporated's liability for the products.

HORIBA Instruments Incorporated products are not intended for any general cosmetic, drug, food, or household application, but may be used for analytical measurements or research in these fields. A condition of HORIBA Instruments Incorporated's acceptance of a purchase order is that only qualified individuals, trained and familiar with procedures suitable for the products ordered, will handle them. Training and maintenance procedures may be purchased from HORIBA Instruments Incorporated at an additional cost. HORIBA Instruments Incorporated cannot be held responsible for actions your employer or contractor may take without proper training.

Due to HORIBA Instruments Incorporated's efforts to continuously improve our products, all specifications, dimensions, internal workings, and operating procedures are subject to change without notice. All specifications and measurements are approximate, based on a standard configuration; results may vary with the application and environment. Any software manufactured by HORIBA Instruments Incorporated is also under constant development and subject to change without notice.

Any warranties and remedies with respect to our products are limited to those provided in writing as to a particular product. In no event shall HORIBA Instruments

Incorporated be held liable for any special, incidental, indirect or consequential damages of any kind, or any damages whatsoever resulting from loss of use, loss of data, or loss of profits, arising out of or in connection with our products or the use or possession thereof. HORIBA Instruments Incorporated is also in no event liable for damages on any theory of liability arising out of, or in connection with, the use or performance of our hardware or software, regardless of whether you have been advised of the possibility of damage.

# Safety summary

The following general safety precautions must be observed during all phases of operation of this instrument. Failure to comply with these precautions or with specific warnings elsewhere in this manual violates safety standards of design, manufacture and intended use of instrument. HORIBA Instruments Incorporated assumes no liability for the customer's failure to comply with these requirements. Certain symbols are used throughout the text for special conditions when operating the instruments:



A WARNING notice denotes a hazard. It calls attention to an operating procedure, practice, or similar that, if incorrectly performed or adhered to, could result in personal injury or death. Do not proceed beyond a WARNING notice until the indicated conditions are fully understood and met. HORIBA Instruments Incorporated is not responsible for damage arising out of improper use of the equipment.



A CAUTION notice denotes a hazard. It calls attention to an operating procedure, practice, or similar that, if incorrectly performed or adhered to, could result in damage to the product. Do not proceed beyond a CAUTION notice until the indicated conditions are fully understood and met. HORIBA Instruments Incorporated is not responsible for damage arising out of improper use of the equipment.

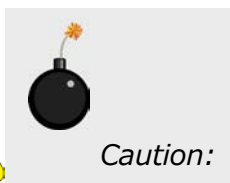

Ultraviolet light! Wear protective goggles, full-face shield, skin-protection clothing, and UV-blocking gloves. Do not stare into light.



Intense ultraviolet, visible, or infrared light! Wear light-protective goggles, full-face shield, skin-protection clothing, and light-blocking gloves. Do not stare into light.



Extreme cold! Cryogenic materials must always be handled with care. Wear protective goggles, full-face shield, skin-protection clothing, and insulated gloves.



Explosion hazard! Wear explosion-proof goggles, full-face shield, skin-protection clothing, and protective gloves.

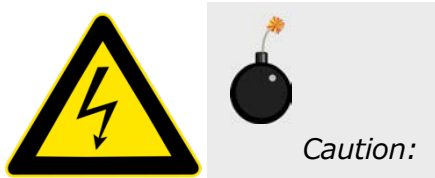

Risk of electric shock! This symbol warns the user that un-insulated voltage within the unit may have sufficient magnitude to cause electric shock.

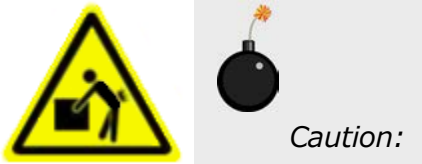

Heavy Lifting Hazard! This symbol warns the user that the equipment is heavy, and should be lifted or moved around only by two people, one at each end with hands under the instrument.



Danger to fingers! This symbol warns the user that the equipment is heavy, and can crush or injure the hand if precautions are not taken.



This symbol cautions the user that excessive humidity, if present, can damage certain equipment.

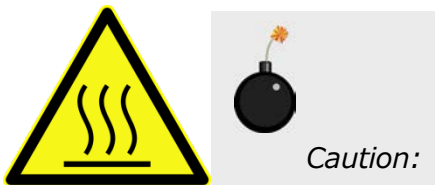

Hot! This symbol warns the user that hot equipment may be present, and could create a risk of fire or burns.



Read this manual before using or servicing the instrument.



Wear protective gloves.



Wear appropriate safety goggles to protect the eyes.



Wear an appropriate face-shield to protect the face.

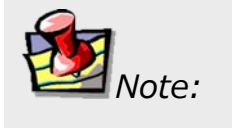

*Note:*

General information is given concerning operation of the equipment.

# Risks of ultraviolet exposure



**Caution:** This instrument is used in conjunction with ultraviolet light. Exposure to these radiations, even reflected or diffused, can result in serious, and sometimes irreversible, eye and skin injuries.

Overexposure to ultraviolet rays threatens human health by causing:

- Immediate painful sunburn
- Skin cancer
- Eye damage
- Immune-system suppression
- Premature aging

Do not aim the UV light at anyone.

Do not look directly into the light.

Always wear protective goggles, full-face shield and skin protection clothing and gloves when using the light source.

- Light is subdivided into visible light, ranging from 400 nm (violet) to 700 nm (red); longer infrared, “above red” or  $> 700\text{nm}$ , also called heat; and shorter ultraviolet radiation (UVR), “below violet” or  $< 400\text{nm}$ . UVR is further subdivided into UV-A or near-UV (320–400 nm), also called black (invisible) light; UV-B or mid-UV (290–320 nm), which is more skin penetrating; and UV-C or far-UV ( $< 290\text{ nm}$ ).
- Health effects of exposure to UV light are familiar to anyone who has had sunburn. However, the UV light level around some UV equipment greatly exceeds the level found in nature. Acute (short-term) effects include redness or ulceration of the skin. At high levels of exposure, these burns can be serious. For chronic exposures, there is also a cumulative risk of harm. This risk depends upon the amount of exposure during your lifetime. The long-term risks for large cumulative exposure include premature aging of the skin, wrinkles and, most seriously, skin cancer and cataract.
- Damage to vision is likely following exposure to high-intensity UV radiation. In adults, more than 99% of UV radiation is absorbed by the anterior structures of the eye. UVR can contribute to the development of age-related cataract, pterygium, photodermatitis, and cancer of the skin around the eye. It may also contribute to age-related macular degeneration. Like the skin, the covering of the eye or the cornea, is epithelial tissue. The danger to the eye is enhanced by the fact that light can enter from all angles around the eye and not only in the direction of vision. This is especially true while working in a dark environment, as the pupil is wide open. The lens can also be damaged, but because the cornea acts as a filter, the chances



are reduced. This should not lessen the concern over lens damage however, because cataracts are the direct result of lens damage.

Burns to the eyes are usually more painful and serious than a burn to the skin. Make sure your eye protection is appropriate for this work. **NORMAL EYEGASSES OR CONTACTS OFFER VERY LIMITED PROTECTION!**



**Caution:** *UV exposures are not immediately felt. The user may not realize the hazard until it is too late and the damage is done.*

## Training

For the use of UV sources, new users must be trained by another member of the laboratory who, in the opinion of the member of staff in charge of the department, is sufficiently competent to give instruction on the correct procedure. Newly trained users should be overseen for some time by a competent person.

# Additional risks of xenon lamps



Among the dangers associated with xenon lamps are:

- Burns caused by contact with a hot xenon lamp.
- Fire ignited by hot xenon lamp.
- Interaction of other nearby chemicals with intense ultraviolet, visible, or infrared radiation.
- Damage caused to apparatus placed close to the xenon lamp.
- Explosion or mechanical failure of the xenon lamp.



**Warning:** Xenon lamps are dangerous. Please read the following precautions.

## Visible radiation

Any very bright visible light source will cause a human aversion response: we either blink or turn our head away. Although we may see a retinal afterimage (which can last for several minutes), the aversion response time (about 0.25 seconds) normally protects our vision. This aversion response should be trusted and obeyed. **NEVER STARE AT ANY BRIGHT LIGHT-SOURCE FOR AN EXTENDED PERIOD.** Overriding the aversion response by forcing yourself to look at a bright light-source may result in permanent injury to the retina. This type of injury can occur during a single prolonged exposure. Excessive exposure to visible light can result in skin and eye damage.

Visible light sources that are not bright enough to cause retinal burns are not necessarily safe to view for an extended period. In fact, any sufficiently bright visible light source viewed for an extended period will eventually cause degradation of both night and color vision. Appropriate protective filters are needed for any light source that causes viewing discomfort when viewed for an extended period of time. For these reasons, prolonged viewing of bright light sources should be limited by the use of appropriate filters.

The blue-light wavelengths (400–500 nm) present a unique hazard to the retina by causing photochemical effects similar to those found in UV-radiation exposure.

## Infrared radiation

Infrared (or heat) radiation is defined as having a wavelength between 780 nm and 1 mm. Specific biological effectiveness “bands” have been defined by the CIE (Commission Internationale de l’Eclairage or International Commission on Illumination) as follows:

- IR-A (near IR) (780–1400 nm)
- IR-B (mid IR) (1400–3000 nm)
- IR-C (far IR) (3000 nm–1 mm)

The skin and eyes absorb infrared radiation (IR) as heat. Workers normally notice excessive exposure through heat sensation and pain. Infrared radiation in the IR-A that enters the human eye will reach (and can be focused upon) the sensitive cells of the retina. For high irradiance sources in the IR-A, the retina is the part of the eye that is at risk. For sources in the IR-B and IR-C, both the skin and the cornea may be at risk from “flash burns.” In addition, the heat deposited in the cornea may be conducted to the lens of the eye. This heating of the lens is believed to be the cause of so called “glassblowers’ ” cataracts because the heat transfer may cause clouding of the lens.

- Retinal IR Hazards (780 to 1400 nm): possible retinal lesions from acute high irradiance exposures to small dimension sources.
- Lens IR Hazards (1400 to 1900 nm): possible cataract induction from chronic lower irradiance exposures.
- Corneal IR Hazards (1900 nm to 1 mm): possible flashburns from acute high irradiance exposures.

Who is likely to be injured? The user and anyone exposed to the radiation or xenon lamp shards as a result of faulty procedures. Injuries may be slight to severe.

# CE compliance statement

The FluoroMax<sup>®</sup> Plus spectrofluorometer is tested for compliance with both the EMC Directive 2004/108/EC and the Low Voltage Directive for Safety 2006/95/EC, and bears the international CE mark as indication of this compliance. HORIBA Instruments Incorporated guarantees the product line's CE compliance only when original HORIBA Instruments Incorporated supplied parts are used. Chapter 15 herein provides a table of all CE Compliance tests and standards used to qualify this product.

# RoHS Declaration of Conformity

Manufacturer: HORIBA Instruments Incorporated

Address: 3880 Park Avenue, Edison, NJ 08520, USA

Products: FluroMax Plus and FluroMax Plus-P spectrometers

HORIBA Instruments Incorporated certifies that the above FluroMax Plus and FluroMax Plus-P models meet the requirements of DIRECTIVE 2002/95/EC, Restriction of Hazardous Substances Directive (RoHS). HORIBA Instruments Incorporated certifies that these FluroMax Plus and FluroMax Plus-P models contain less than the following amounts of the six RoHS banned substances with the exemption stated in Note 2 below:

Substance	Threshold Level
Lead...Pb	Less than 0.1% <sup>1&amp;2</sup>
Mercury...Hg	Less than 0.1% <sup>1</sup>
Hexavalent Chromium...Cr(VI)	Less than 0.1% <sup>1</sup>
Polybrominated Biphenyls...PBB	Less than 0.1% <sup>1</sup>
Polybrominated Diphenyl Ethers...PBDE	Less than 0.1% <sup>1</sup>
Cadmium...Cd	Less than 0.01% <sup>1</sup>
Notes:	
1. Tolerated maximum concentration value by weight in homogeneous materials.	
2. Exemptions—Lead as an alloying element in steel containing up to 0.35% lead by weight, aluminum containing up to 0.4% lead by weight and as a copper alloy containing up to 4% lead by weight.	

Manufacturer's Authorized Representative:

\_\_\_\_\_  
 Cary Davies  
 Director of Fluorescence Division

Date:

# Waste Electrical and Electronic Equipment (WEEE)

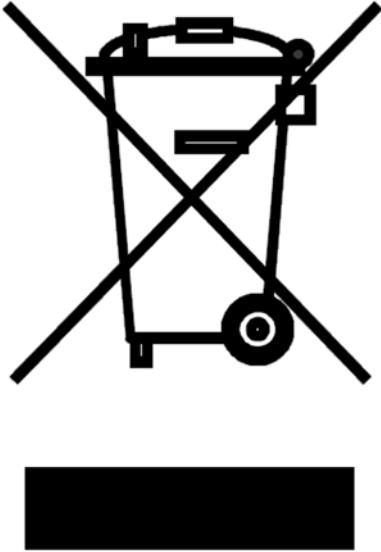

## WEEE Directive Symbol

This symbol on the product or its packaging indicates that this product must not be disposed of with regular waste. Instead, it is the user's responsibility to dispose of waste equipment according to local laws. The separate collection and recycling of the waste equipment at the time of disposal will help to conserve natural resources and ensure that it is recycled in a manner that protects human health and the environment. For information about where the user can drop off the waste equipment for recycling, please contact your local HORIBA Scientific representative.

# 1 : Requirements & Installation

## Safety-training requirements

Every user of the FluoroMax<sup>®</sup> Plus and FluoroMax<sup>®</sup> Plus-P must know general and specific safety procedures before operating the instrument. For example, proper training includes (but is not limited to):

- Understanding the risks of exposure to ultraviolet, visible, and infrared light, and how to avoid unsafe exposures to these types of radiation
- Handling xenon-lamp bulbs, and their dangers
- Safe handling for all chemicals and other samples used in the instrument

Safety-training may be purchased from HORIBA Scientific. Contact your Sales Representative or the Service Department for details.

# Surface requirements

- A sturdy table- or bench-top
- Surface must hold 90 kg (200 lbs.).
- Surface should be about 27" × 72" (69 cm × 183 cm) to hold spectrofluorometer, computer, and accessories comfortably.
- Overhead clearance should be at least 36" (91 cm).



# Environmental requirements

- Temperature 59–86°F (15–30°C)
- Maximum temperature fluctuation  $\pm 2^{\circ}\text{C}$
- Ambient relative humidity  $< 75\%$



*Caution: Excessive humidity can damage the optics.*

- Low dust levels
- No special ventilation



*Caution: For adequate cooling, do not cover, block, or obstruct the vents on the left side and underside of the instrument.*

# Electrical requirements

The FluoroMax<sup>®</sup> Plus series operates from universal AC single-phase input power over the range of 90 to 240 V AC with a line frequency of 50 to 60 Hz. This AC input power is applied to a two-pole fusing power entry module located on the side of the instrument. This module incorporates two 5 × 20 mm IEC approved, 4.0 A, 250 V, Time Delay fuses (Cooper Bussman part number GDC-4A or equivalent) to protect against line disturbances or anomalies outside the system's normal operating range.

Have enough outlets available for:

- Host computer (PC)
- Monitor
- Optional printer
- FluoroMax<sup>®</sup> Plus or FluoroMax<sup>®</sup> Plus-P
- Special power supplies for the second detector
- Each of certain accessories, such the MicroMax, temperature bath, etc.



*Caution: HORIBA Scientific is not liable for damage from line surges and voltage fluctuations. A surge protector is strongly recommended for minor power fluctuations. For more severe voltage variations, use a generator or uninterruptible power supply. **Improper line voltages can damage the equipment severely.***



*Warning: The FluoroMax<sup>®</sup> Plus series is equipped with a three-conductor power cord that is connected to the system frame (earth) ground. This ground provides a return path for fault current from equipment malfunction or external faults. For all instruments, ground continuity is required for safe operation. Any discontinuity in the ground line can make the instrument unsafe for use. **Do not operate this system from an ungrounded source.***



*Note: HORIBA Scientific recommends connecting the host computer, monitor, and printer to a single surge-protector, to make start-up more convenient, and to conserve AC outlets. Connect the FluoroMax<sup>®</sup> Plus to a separate line, if possible, to isolate the xenon-lamp power supply inside the FluoroMax<sup>®</sup> Plus.*

# Unpacking and installation

## Introduction

The FluoroMax<sup>®</sup> Plus series spectrofluorometer system is delivered in a single packing carton. If a host computer (PC) is ordered as a part of the system, the PC is delivered in a few clearly labeled boxes. All accessories, cables, software, and manuals ordered with the system are included with the delivery.

Examine the shipping boxes carefully. Any evidence of damage should be noted on the delivery receipt and signed by representatives of the receiving and carrier companies. Once a location has been chosen, unpack and assemble the equipment as described below. To avoid excessive moving and handling, the equipment should be unpacked as close as possible to the selected location.



*Note: Many public carriers will not recognize a claim for concealed damage if it is reported later than 15 days after delivery. In case of a claim, inspection by an agent of the carrier is required. For this reason, the original packing material should be retained as evidence of alleged mishandling or abuse. While HORIBA Instruments Incorporated assumes no responsibility for damage occurring during transit, the company will make every effort to aid and advise.*



*Caution: The spectrofluorometer system is a delicate instrument. Mishandling may seriously damage its components.*

## FluoroMax<sup>®</sup> Plus series carton contents

Quantity	Item	Part number
1	FluoroMax <sup>®</sup> Plus or FluoroMax <sup>®</sup> Plus-P	
1	USB cable	J980087
1	<i>FluoroMax<sup>®</sup> Plus Operation Manual</i>	J810005
1	Set of Allen wrenches (Allen keys)	J53057
1	Single-cell sample-holder	J351697
1	Power cord (110 V)	J98015
	(220 V)	J98020
1	FluorEssence <sup>™</sup> software package	

## Directions

### 1 Unpack and set up the FluoroMax<sup>®</sup> Plus.

- a Carefully open the FluoroMax<sup>®</sup> Plus shipping carton.
- b Remove the foam-injected top piece and any other shipping restraints in the carton.
- c The equipment is heavy, and should be lifted or moved around only by two people, one at each end with hands under the instrument. It is heavy enough to crush or injure the hand. Carefully lift the instrument from the carton, and place it on the laboratory bench where the system will stay.



*Caution: Heavy Lifting Hazard!*



*Caution: Danger to fingers!*

- d Place the instrument in its permanent location.
- e Level the spectrofluorometer.  
Adjust the four leveling feet on the bottom of the instrument.
- f Inspect for previously hidden damage.  
Notify the carrier and HORIBA Scientific if any is found.
- g Check the packing list to verify that all components and accessories are present.
- h Plug one end of the power cord into the proper receptacle on the right side (while facing the unit) of the spectrofluorometer.



- i Plug one end of the USB cable into the USB receptacle.

- j With an optional trigger accessory, plug one end of the trigger cable into the TRIGGER connector on the FluoroMax<sup>®</sup> Plus. Allow the unconnected ends of the cables to dangle freely; they will be connected in later steps.

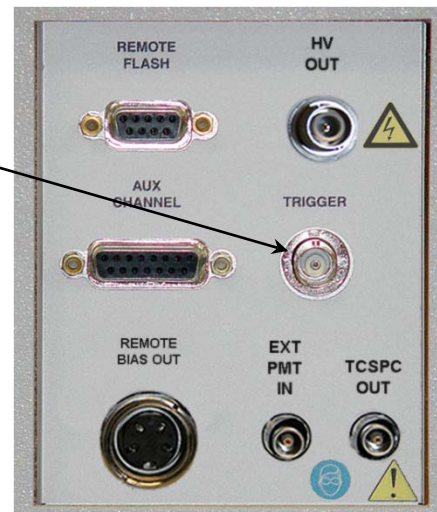

## 2 Set up the computer.

The information gathered by the spectrofluorometer system is displayed and controlled through the host PC via FluorEssence<sup>™</sup> software. The host PC may be purchased from HORIBA Scientific or another supplier.

- a Set up the host PC reasonably close to the FluoroMax<sup>®</sup> Plus system. The limitation is the length of the USB cable. The recommended location for the PC is just to the right of the spectrofluorometer, but other positions are possible.
- b Follow the instructions for the host PC to set up the computer system, including the CPU, monitor, keyboard, mouse, speakers, printers, etc.

## 3 Install the FluorEssence<sup>™</sup> software.

The spectrofluorometer system is controlled by FluorEssence<sup>™</sup> spectroscopy software operating within the Windows<sup>®</sup> environment. If the computer and software were purchased from HORIBA Scientific, the software installation is complete. If the computer is not from HORIBA Scientific, perform the installation. Contact a HORIBA Scientific Sales Representative for recommended specifications for a suitable host computer.

Before the FluorEssence<sup>™</sup> software can be installed, however, Windows<sup>®</sup> must be installed already and operating properly. Refer to the Windows<sup>®</sup> manual that came with the computer for installation instructions.

The FluorEssence<sup>™</sup> software is supplied on one CD-ROM. Follow the *FluorEssence<sup>™</sup> User's Guide* for details on installation.



*Note: Be sure to agree to the terms of the software license before using the software.*

*A USB dongle is supplied with FluorEssence<sup>™</sup>. This dongle (license) must be connected to the host PC before FluorEssence<sup>™</sup> will operate.*

## 4 Connect the FluoroMax<sup>®</sup> Plus to the computer.

- a Attach the free end of the USB cable to a USB receptacle on the host computer.
- b With all devices OFF, plug the power cords from the monitor, computer, FluoroMax<sup>®</sup> Plus, and the printer into properly grounded (earthed) receptacles.
- c Install any accessories that arrived with the system, using the instructions that accompany the accessories.  
See Chapter 12 for a detailed list of accessories.

### **Users outside of the USA:**

Users outside of the USA receive a softkey device that connects to the printer port of the host computer for software security. The softkey should be left in place on the host computer at all times.



*Note: Copying, disassembly, or removal of the softkey is illegal.*

# Software emulation

Emulating the FluorEssence™ software means letting the computer act as though the FluoroMax® Plus is properly connected, even if it isn't.

- 1 Disconnect the communications cable from the host computer to the FluoroMax® Plus.





*Note: Be sure the FluorEssence™ USB key is inserted into a free USB port on the host computer. Without the key, FluorEssence™ will not run properly, even in emulation mode.*

- 2 Double-click the FluorEssence icon to start FluorEssence™.

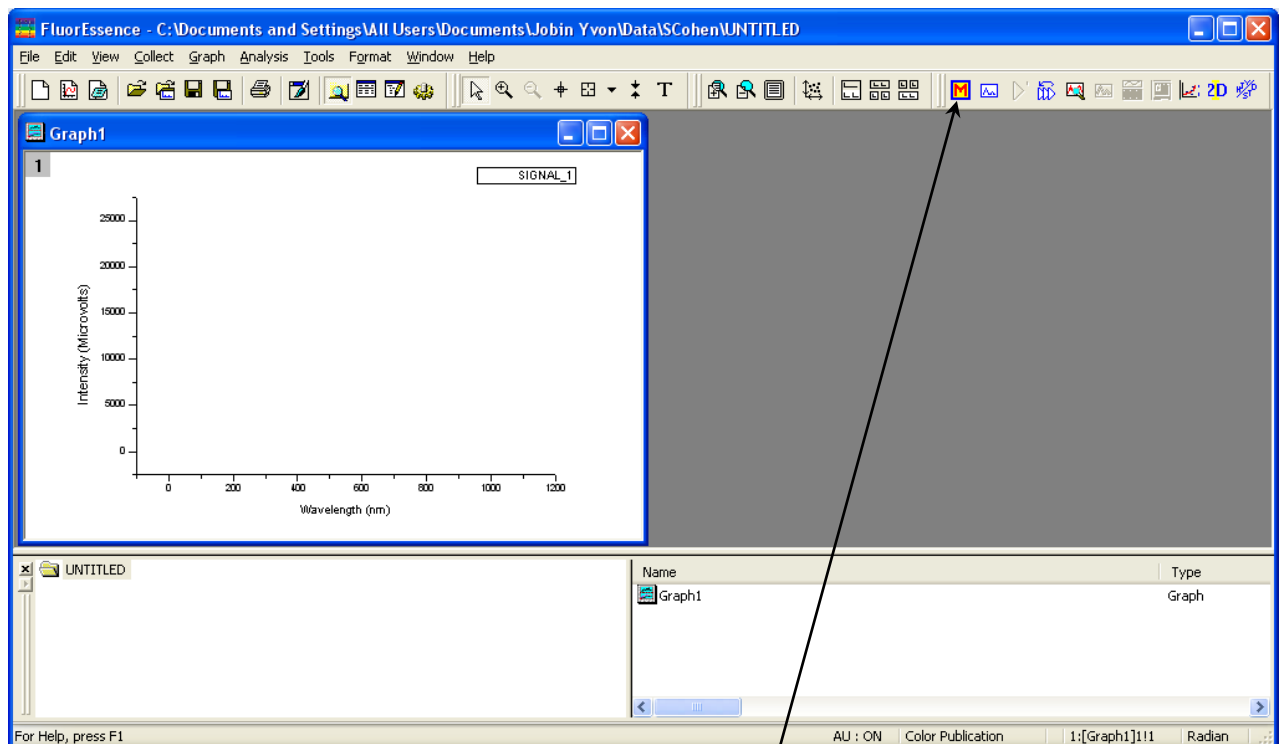

The main FluorEssence window opens:



- 3 Click the Experiment Menu button  to open a hardware configuration.

The Select Hardware Configuration window opens.

4 Choose the desired instrument you wish to emulate.

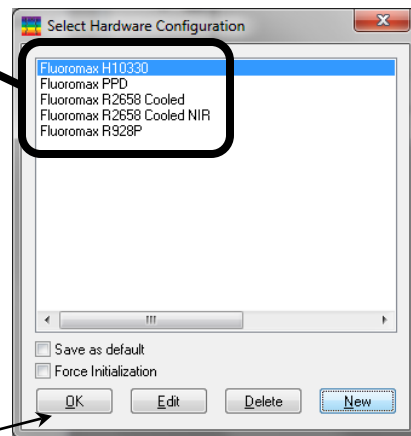

*Note: All FluoroMax<sup>®</sup> Plus instruments have an R928P, plus only ONE of the other possible configurations shown here.*

5 Click the OK button.

The System Initialization Process window opens:

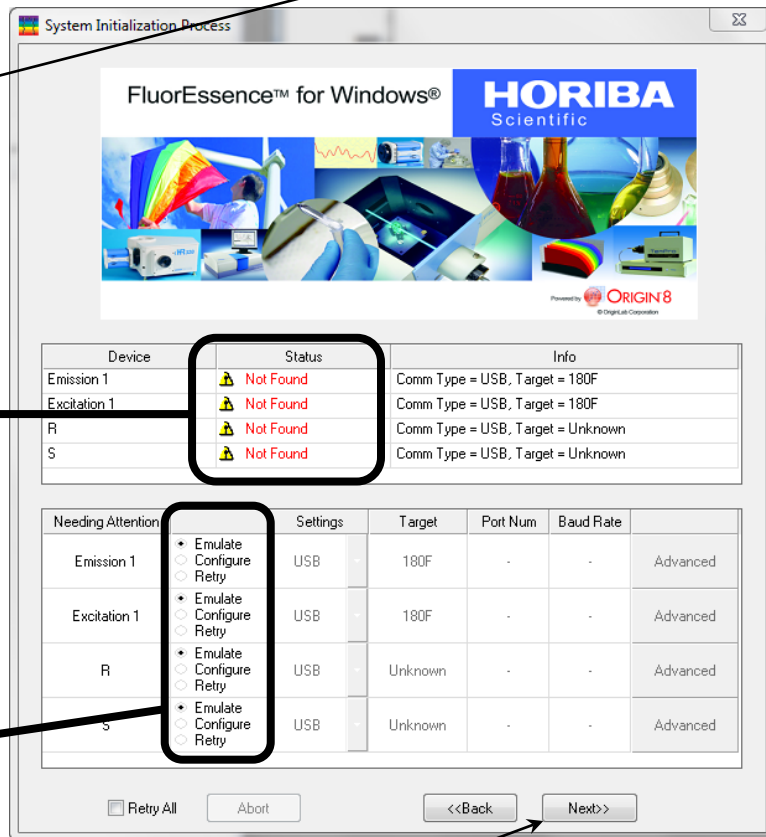

Under the Status column, warning symbols appear for the hardware devices, noting that they were Not Found. Thus FluorEssence<sup>™</sup> chooses the Emulate radio button as the default action for each device.

6 Click the Next>> button.

The Fluorescence Main Experiment Menu appears. FluorEssence<sup>™</sup> is now emulating the instrument.

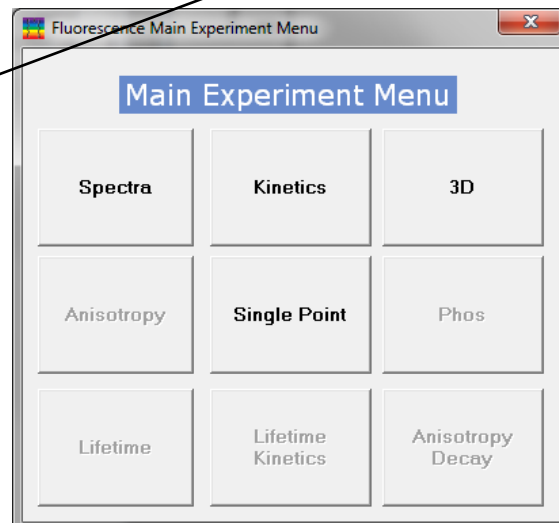



# 2 : System Description



*Warning: Do not open the instrument without proper training, appropriate protection, and having read this operation manual. The instrument contains dangerous voltages, ultraviolet, visible, and infrared radiation, and fragile light-sources. In addition, tampering with the optical components can irreversibly damage them.*

## Introduction

A spectrofluorometer is an analytical instrument used to measure and record the fluorescence of a sample. While recording the fluorescence, the excitation, emission, or both wavelengths may be scanned. With additional accessories, variation of signal with time, temperature, concentration, polarization, or other variables may be monitored.

## Basic theory of operation

A continuous source of light shines onto an excitation monochromator, which selects a band of wavelengths. This monochromatic excitation light is directed onto a sample, which emits luminescence. The luminescence is directed into a second, emission monochromator, which selects a band of wavelengths, and shines them onto a detector. The signal from the detector is reported to a system controller and host computer, where the data can be manipulated and presented, using special software.

# Optical layout

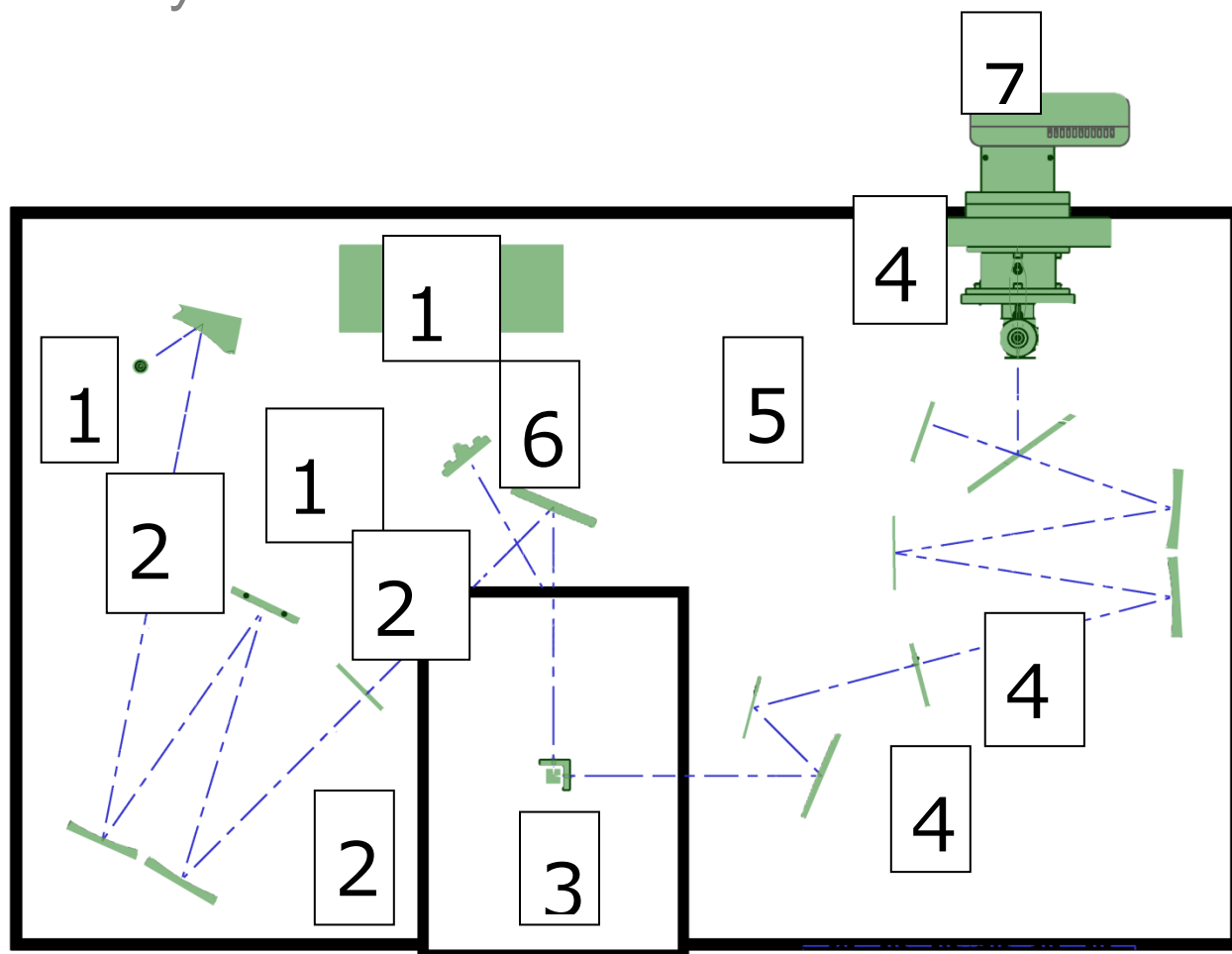

- 1 Xenon arc-lamp and lamp housing
  - 1a Xenon-lamp power supply
  - 1b Xenon flash lamp (FluoroMax® Plus-P only)
  - 2 Excitation monochromator
  - 2a & 2b Slits
  - 3 Sample compartment
  - 4 Emission monochromator
  - 4a & 4b Slits
  - 5 Internal signal detector (photomultiplier tube and housing)
  - 6 Reference detector (photodiode and current-acquisition module)
  - 7 External signal detector (exact shape varies with model)
- Host computer (not on diagram)

## Illuminator (xenon arc-lamp, 1)

The continuous light source is a 150-W ozone-free xenon arc-lamp. Light from the lamp is collected by a diamond-turned elliptical mirror, and then focused on the entrance slit of the excitation monochromator. The lamp housing is separated from the excitation monochromator by a quartz window. This vents heat out of the instrument, and protects against the unlikely occurrence of lamp failure.

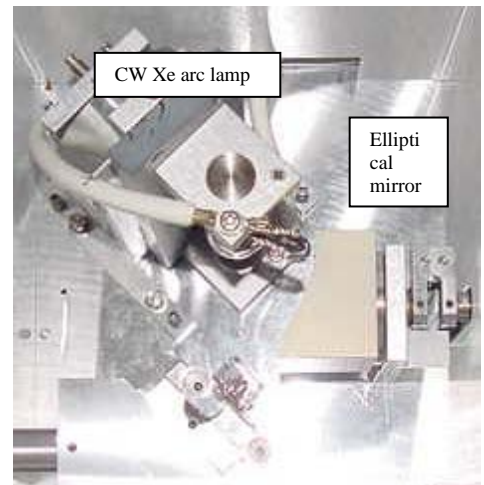

In the FluoroMax<sup>®</sup> Plus with phosphorimeter, a second source, a xenon flash lamp, is available also. A FluorEssence<sup>™</sup>-controlled motor and gearbox rotate the mirror in the illumination area, in order to switch between the CW source and the flash lamp.

**Right: Motor and gearbox that rotate the mirror to switch lamps (optional phosphorimeter only).**

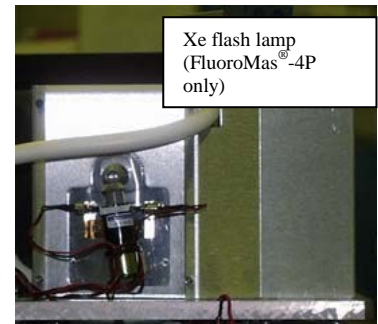

## Monochromators (2 and 4)

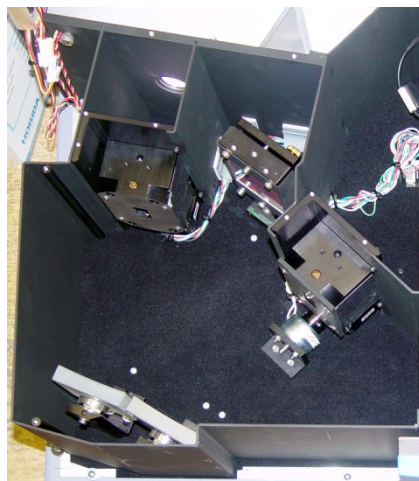

**Excitation monochromator.**

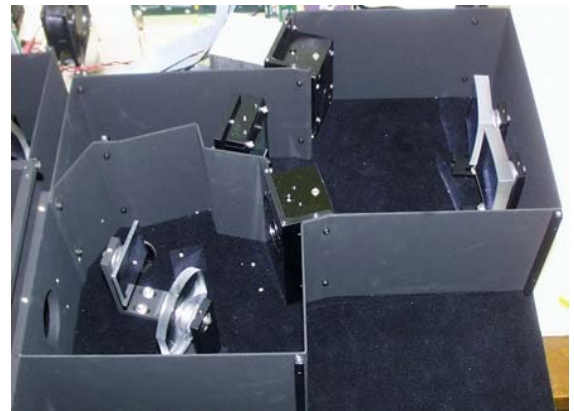

**Emission monochromator.**

The FluoroMax<sup>®</sup> Plus contains Czerny-Turner monochromators for excitation and emission. The Czerny-Turner design uses all-reflective optics to maintain high resolution over the entire spectral range, eliminate chromatic aberration for high light-throughput, and minimize spherical aberrations and re-diffraction.

### Gratings

The essential part of a monochromator is a reflection grating. A grating disperses the incident light by means of its vertical grooves. A spectrum is obtained by rotating the gratings, and recording the intensity values at each wavelength. The gratings in



the FluoroMax<sup>®</sup> Plus contain 1200 grooves mm<sup>-1</sup>, and are blazed at 330 nm (excitation) and 500 nm (emission). Blazing is etching the grooves at a particular angle, to optimize the grating's reflectivity in a particular spectral region. The wavelengths selected are optimal for excitation in the UV and visible, and for emission in the high-UV to near-IR. Each grating is coated with MgF<sub>2</sub> for protection against oxidation. The system uses a direct drive for each grating, to scan the spectrum at up to 80 nm s<sup>-1</sup>, with accuracy better than 0.5 nm, and repeatability of 0.3 nm.

If Fluoromax-Plus is configured with either H10330 or R2658 external detector, the emission monochromator will be equipped with a dual grating cassette with back to back gratings: 1200 grooves mm<sup>-1</sup> blazed at 500nm and 600 grooves mm<sup>-1</sup> blazed at 1 micron.

## Slits

The entrance and exit ports of each monochromator have continuously adjustable slits controlled by FluorEssence<sup>™</sup>. The width of the slits on the excitation monochromator determines the bandpass of light incident on the sample and the spectral resolution. The emission monochromator's slits control the spectral resolution and intensity of the fluorescence signal recorded by the signal detector.

When setting slit width, the trade-off is intensity of signal versus spectral resolution. The wider the slits are, the more light falls on the sample and detector, but the resolution decreases. The narrower the slits are, the higher the resolution gets, but at the expense of signal. Set the slits for intensity toward the higher end of the detector's linear response, with sharp-enough resolution to discern desired spectral features.

Slits may be set in bandpass units, or the physical width of the slit (mm). Under bandpass units, each monochromator's slits are set simultaneously, for the bandpass is determined by the dispersion of the monochromator:

$$\text{bandpass (in nm)} = \text{slit width (in mm)} \times \text{dispersion (in nm mm}^{-1}\text{)}$$

The dispersion of FluoroMax<sup>®</sup> Plus monochromators is 4.25 nm mm<sup>-1</sup> for gratings with 1200 grooves mm<sup>-1</sup> at 540 nm. Below is a table showing standard slit-widths with their corresponding bandpasses.

Slit width (mm)	Bandpass (nm)	Rounded bandpass (nm)
0.50	2.125	2
1.175	4.994	5
2.00	8.500	8.5

## Shutters

An excitation shutter, standard on the FluoroMax<sup>®</sup> Plus, is located just after the excitation monochromator's exit slit. The shutter protects samples from photobleaching or photodegradation from prolonged exposure to the light source. FluorEssence<sup>™</sup> controls the shutter, and can set the shutter to automatic or anti-photobleaching modes. An emission shutter is an optional accessory, placed just before the emission monochromator's entrance, and protects the detector from bright light.



*Caution: Operation of the instrument when the excitation shutter is disabled may expose the user to excessive light. Wear light-blocking goggles or face-shield, and light-blocking clothing and gloves.*

## Sample compartment (3)

A toroidal mirror focuses the beam from the excitation monochromator on the sample. About 8% of this excitation light is split off, using a beam-splitter, to the reference photodiode. Fluorescence from the sample is then collected and directed to the emission monochromator.

The sample compartment accommodates various optional accessories, as well as fiber-optic bundles to take the excitation beam to a remote sample (or the MicroMax), and return the emission beam to the emission monochromator. See Chapter 12 for a list of accessories.

### **To insert or remove a sample platform,**

- 1** If a multiple-sample turret is installed, shut off the system.
- 2** Remove the four screws on the front of the sample platform.
- 3** Slide out the old platform.
- 4** Slide in the new platform.
- 5** If the platform has a rotatable turret or magnetic stirrer, slide the 15-pin connector gently and securely onto the 15-pin receptacle in the sample compartment.
- 6** Re-attach the four screws on the front of the sample platform.

## Detectors (5, 6, and 7)

Each FluoroMax<sup>®</sup> Plus contains three detectors:

- Signal detector**

The standard signal detector is a photon-counting detector (R928P photomultiplier tube). The detector's response ranges from 180–850 nm, with dark counts < 1000 counts per second (cps). The linear range for photon counting is 0–2 million cps. The working range is up to 2 million cps. Above 2 million cps, photon-pulse pile-up reduces the signal-to-noise ratio, and causes the detector to lose its linear response.
- Second (external) signal detector**

Attached to the back of the FluoroMax<sup>®</sup> Plus chassis is a second detector chosen by the customer. Possible second detectors are: R2658, PPD, or H10330.
- Reference detector**

The reference detector monitors the xenon lamp, in order to correct for wavelength- and time-dependent output of the lamp. This detector is a UV-enhanced silicon photodiode, which is just before the sample compartment. It requires no external bias, and has good response from 190–980 nm.



The reference and signal detectors have correction-factor files run for them, to correct for wavelength dependencies of each optical component. The files are created at HORIBA Scientific for every instrument, and may be applied to data through FluorEssence™. See Chapter 8 for more details.

## Electronics and controllers (1a)

The rear and bottom of the FluoroMax<sup>®</sup> Plus houses the electronics for running the lamp, instrument, scans, and measurements.

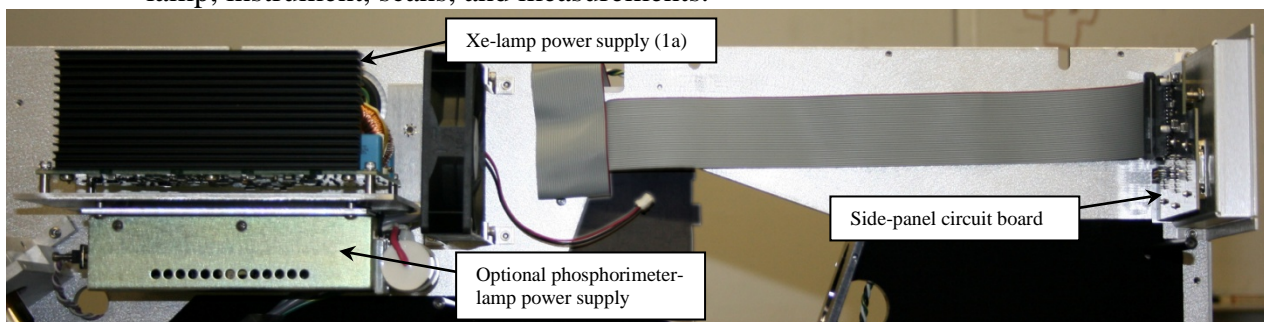

### Lamp power supply (1a), optional phosphorimeter power supply, and side-panel circuit board.

- Xenon-lamp power supply (1a)**

This supply is a tunable 180-W-maximum power supply. It supplies a large start-up voltage to the 150-W xenon lamp, then holds the lamp steady at 15 V. The voltage is filtered, to stabilize the illumination as much as possible. The lamp is started with the rocker-switch on the right panel of the instrument, and controlled through

- J400906 software.  
board      Underneath the optical platform, there is a control board. This controls the monochromators and any optional accessories connected to the sample compartment.

## Computer system and software (not on diagram)

Not shown on the schematic is the host computer with FluorEssence<sup>™</sup> software. The technical specifications chapter lists the computer requirements. An optional printer or network card is useful for printing. FluorEssence<sup>™</sup> software for Windows<sup>®</sup> controls all interaction with the spectrofluorometer. For information on FluorEssence<sup>™</sup>, see the *FluorEssence<sup>™</sup> User's Guide* and the on-line help files within FluorEssence<sup>™</sup>.





# 3 : System Operation

## Introduction

This chapter explains how to turn on the FluoroMax<sup>®</sup> Plus system, check its calibration, and, if necessary, recalibrate the monochromators. While doing these procedures, how to define a scan, run a scan, and optimize system settings to obtain the best results is explained.

## Power switch

The power switch is located on the lower right-hand side of the instrument. When switched on, the xenon lamp arcs initially, and the FluoroMax<sup>®</sup> Plus turns on, runs through self-diagnostics, then starts the xenon lamp.



**Note:** HORIBA Scientific suggests leaving the lamp on during brief periods of inactivity.

# Turning on the system



## 1 Turn on the FluoroMax<sup>®</sup> Plus.

Turn the power switch to the ON (1) position.

## 2 Turn on instrument accessories.

Accessories include a temperature bath, MicroMax, etc.

## 3 Turn on all peripheral devices for the host PC.

Peripherals include any printers or other output devices.

## 4 Start the host computer.

a Switch on the host computer.

b Click the FluorEssence<sup>™</sup> icon on the Windows<sup>®</sup> desktop.

c The instrument initializes, then the **FluorEssence** window appears. If there are any difficulties, see the troubleshooting chapter.



**Warning:** When the xenon lamp is ignited, a large voltage is applied across the lamp. Therefore, never operate the lamp with the cover removed. An extremely rare occurrence is the explosion of the xenon lamp upon ignition. Therefore, take care in case tiny lamp shards exit the ventilation fans.

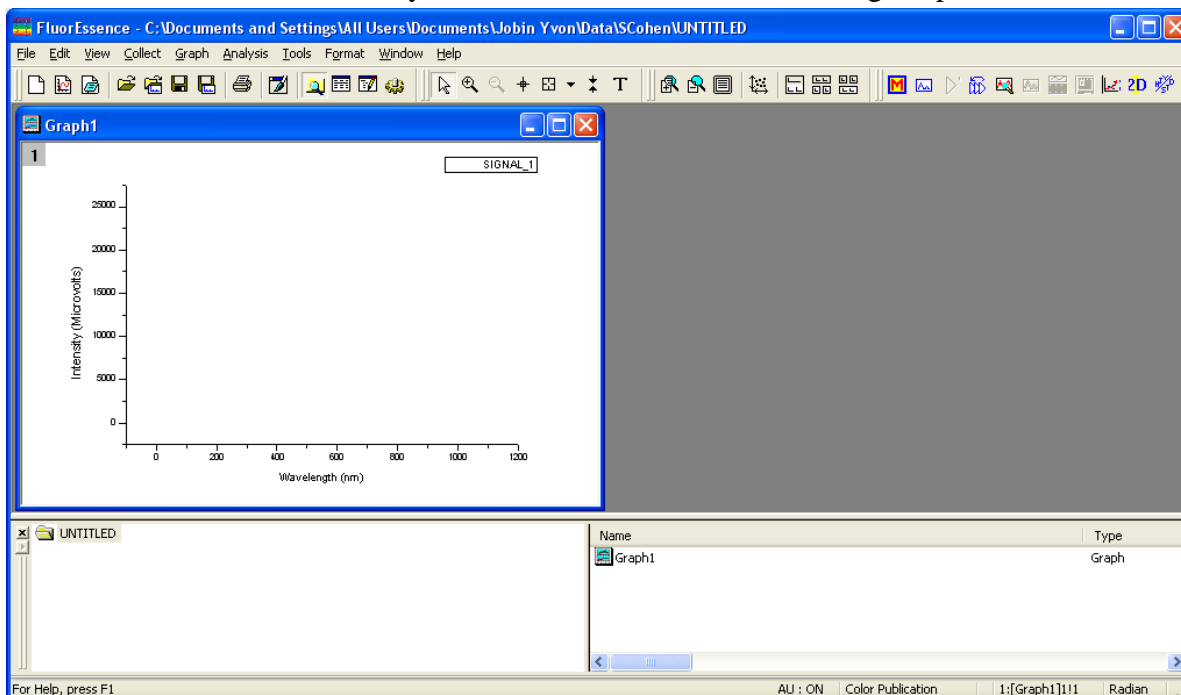

# Checking system performance

## Introduction

Upon installation and as part of routine maintenance checks, examine the performance of the FluoroMax<sup>®</sup> Plus. HORIBA Scientific recommends checking the system calibration before each day of use with the system. Scans of the xenon-lamp output and the Raman-scatter band of water are sufficient to verify system *calibration*, *repeatability*, and *throughput*.

- *Calibration* is the procedure whereby the drive of each monochromator is referenced to a known spectral feature. One verifies the excitation and emission monochromators' calibration at a particular wavelength in this step.
- *Repeatability* is the ability of the system to produce consistent spectra.
- *Throughput* is the amount of signal passing through and detected by the system. The throughput is correlated to the signal-to-noise ratio and sensitivity of the system.

The FluoroMax<sup>®</sup> Plus is an autocalibrating spectrofluorometer. This means the system initializes its monochromators' drives, locates the home position of the each drive, and assigns a wavelength value to this position from a calibration file. While the system usually maintains calibration by this method, it is wise to check the calibration prior to the day's session with the instrument. For the calibration checks detailed here, a single-sample mount or automated sample changer should be the only sample-compartment accessories used.

The scans shown herein are *examples*. A Performance Test Report for your new instrument is included with the documentation. Use the Performance Test Report to validate the spectral shape and relative intensity taken during the calibration checks.



**Note:** HORIBA Scientific is not responsible for customer errors in calibration. To be sure that your instrument is properly calibrated, call Fluorescence Service for assistance. We can arrange a visit and calibrate your instrument for a fee.

## Excitation-monochromator calibration check

This calibration check verifies the wavelength calibration of your excitation monochromator, using the reference photodiode located before the sample compartment. It is an excitation scan of the xenon lamp's output, and should be the first check performed.

- 1 Close the lid of the sample compartment.
- 2 On the main FluorEssence toolbar, select the Experiment Menu button :

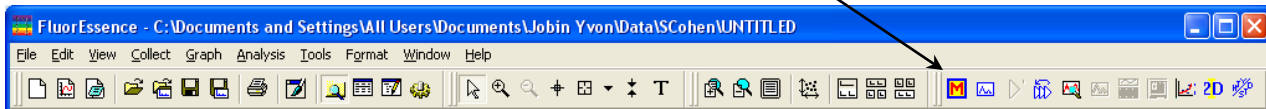

The Fluorescence **Main Experiment Menu** appears:

- 3 Choose Spectra.

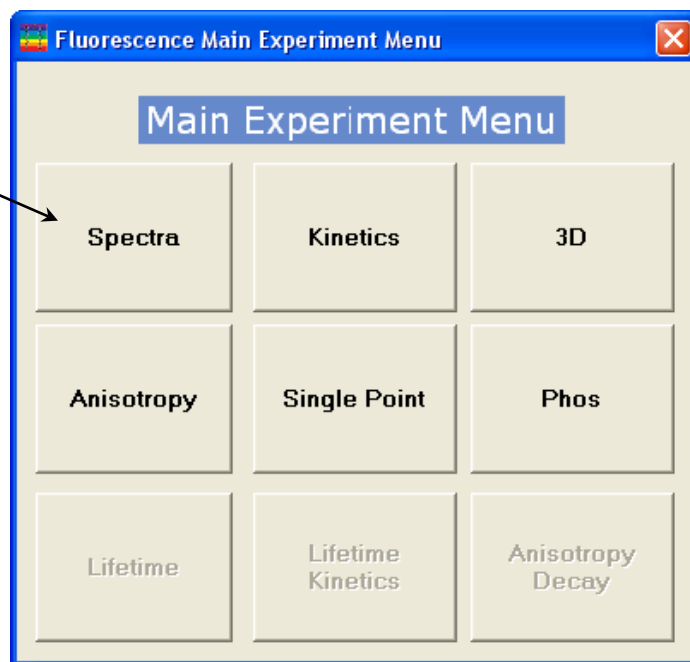

The **Experiment Type** window appears:

- 4 Choose Excitation.

The xenon-lamp scan experiment automatically loads:

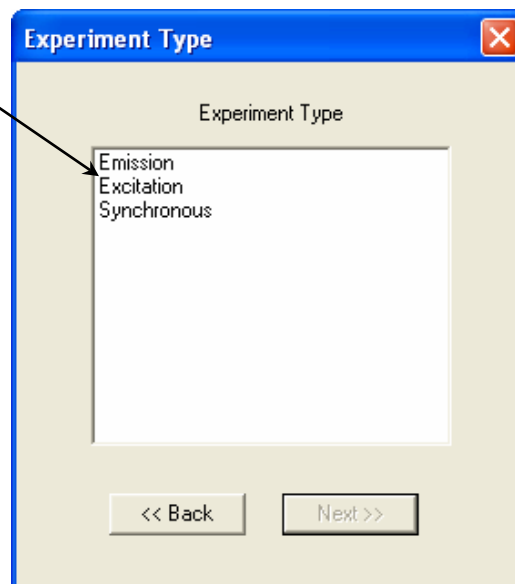

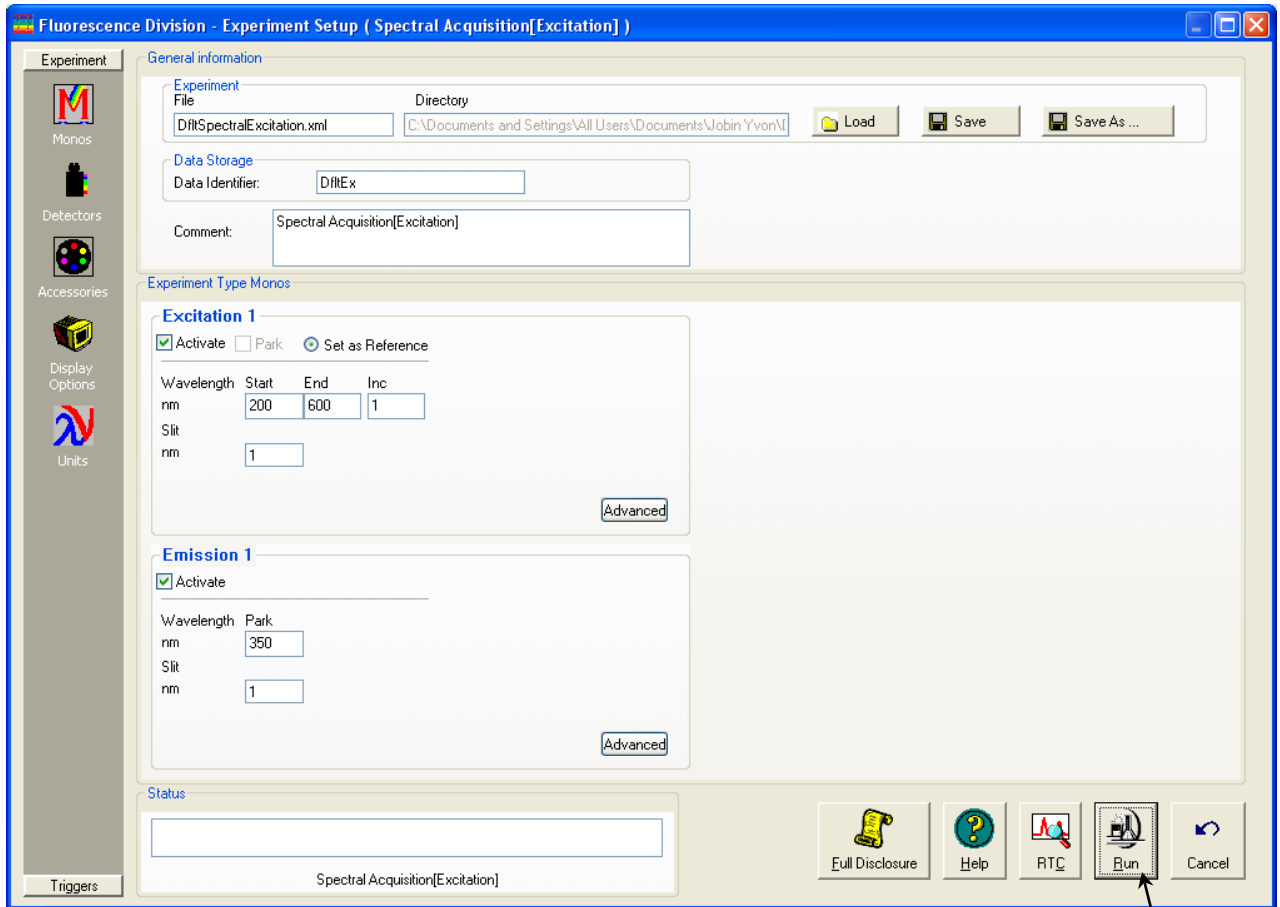

5 Use the default parameters or adjust them.

**Default monochromator parameters for the xenon-lamp scan**

Monochromator (1200 grooves/mm)	Initial wave-length	Final wave-length	Increment	Slits (band-pass)
Excitation	200 nm	600 nm	1 nm	1 nm
Emission	350 nm	--	--	1 nm

**Default detector parameters for the xenon-lamp scan**

Detector (Signal)	Integration time	Units
Reference (R1)	0.1 s	mA

6 Click the Run button .

The **Intermediate Display** opens. The xenon-lamp scan runs:

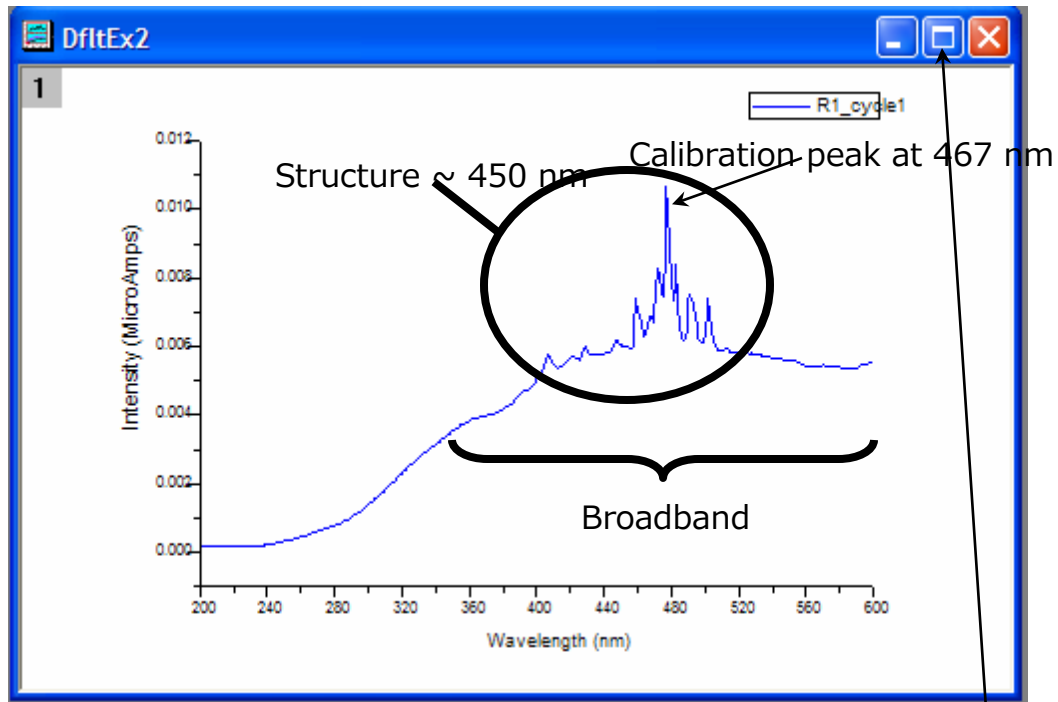

This is an uncalibrated FluoroMax Plus<sup>®</sup> lamp scan. The main peak ought to be at 467 nm, but here appears near 480 nm.



**Note:** Your lamp scan may appear different, depending on the instrument configuration.

## 7 Calibrate the excitation monochromator, if required.

- a With the **Graph** tab active, double-click the plot to make the plot active.
- b Expand the plot by clicking the **Expand** button.
- c Click the cursor button  to start the **Cursor** function.

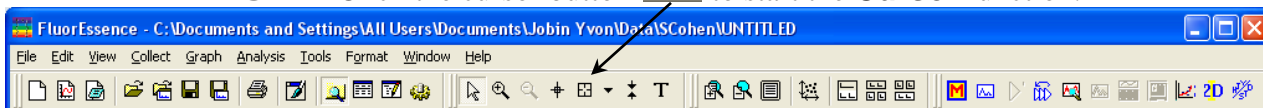

- d Click on the graph near the peak, to place the cursor on the graph.
- e Using the left and right arrows on the keyboard, move the cursor to the top of the peak.
- f Read the  $x$ -value of this plot: this is the wavelength of the peak.

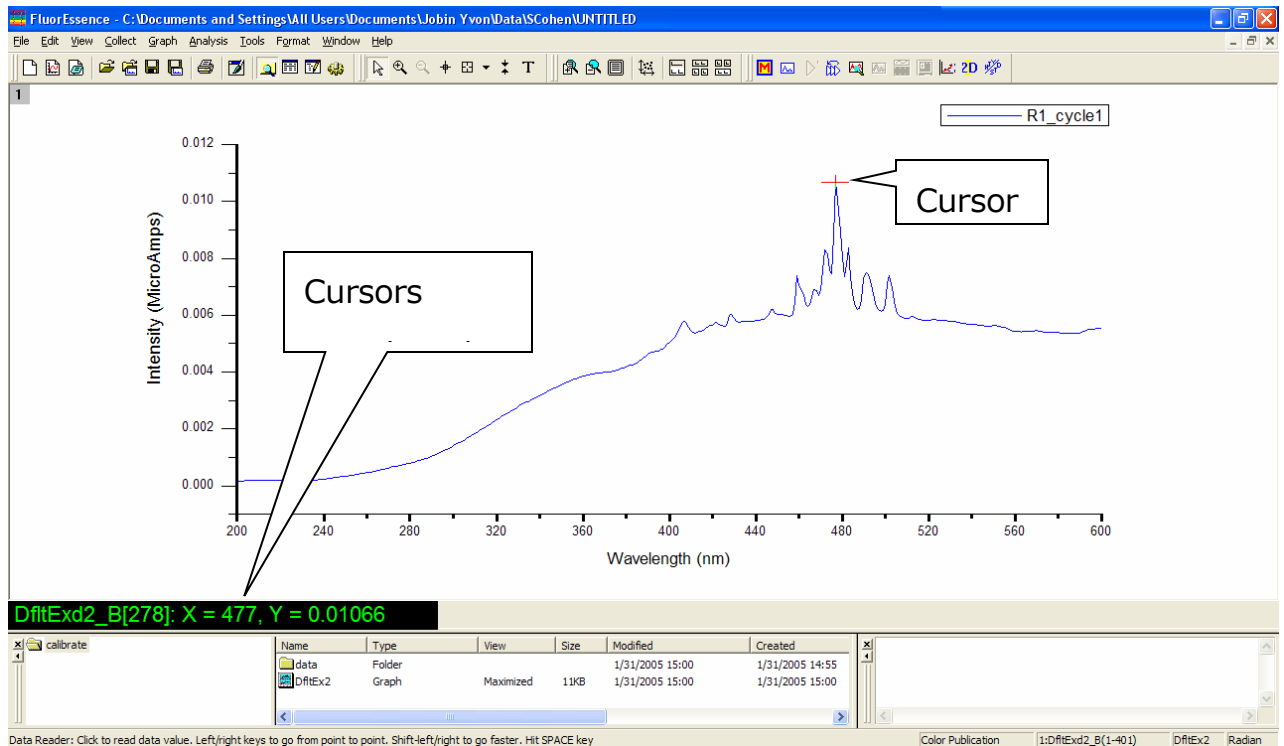

This example shows the peak actually at 477 nm, which is 10 nm too high. Therefore we must recalibrate the monochromator.

g Click the **Previous Experiment** button.

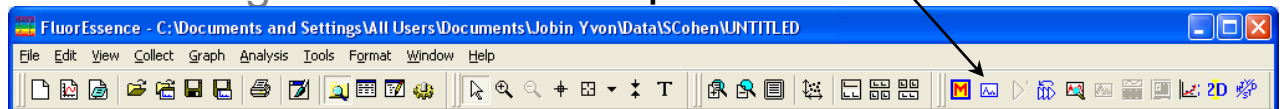

The **Experiment Setup** window appears.

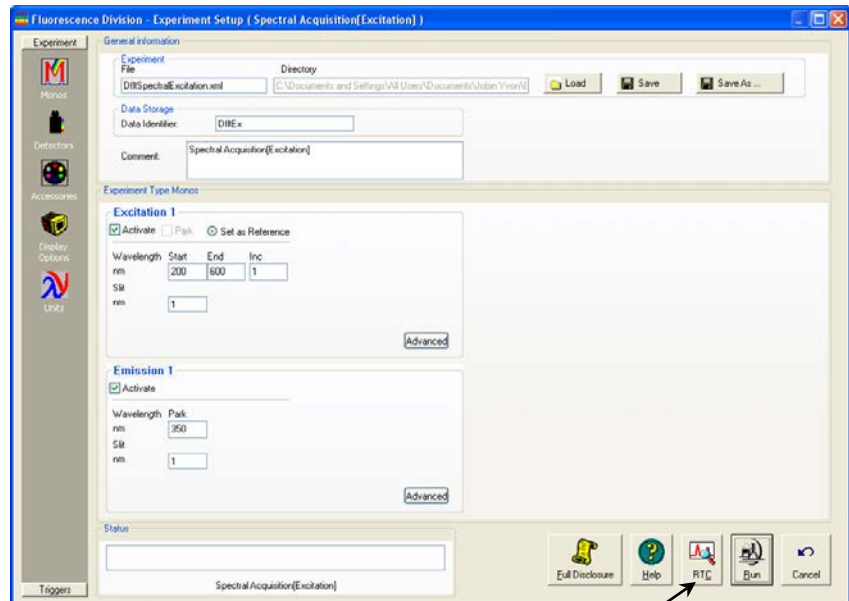

h Click the **RTC** button on the lower right. The **Real Time Control** window opens:

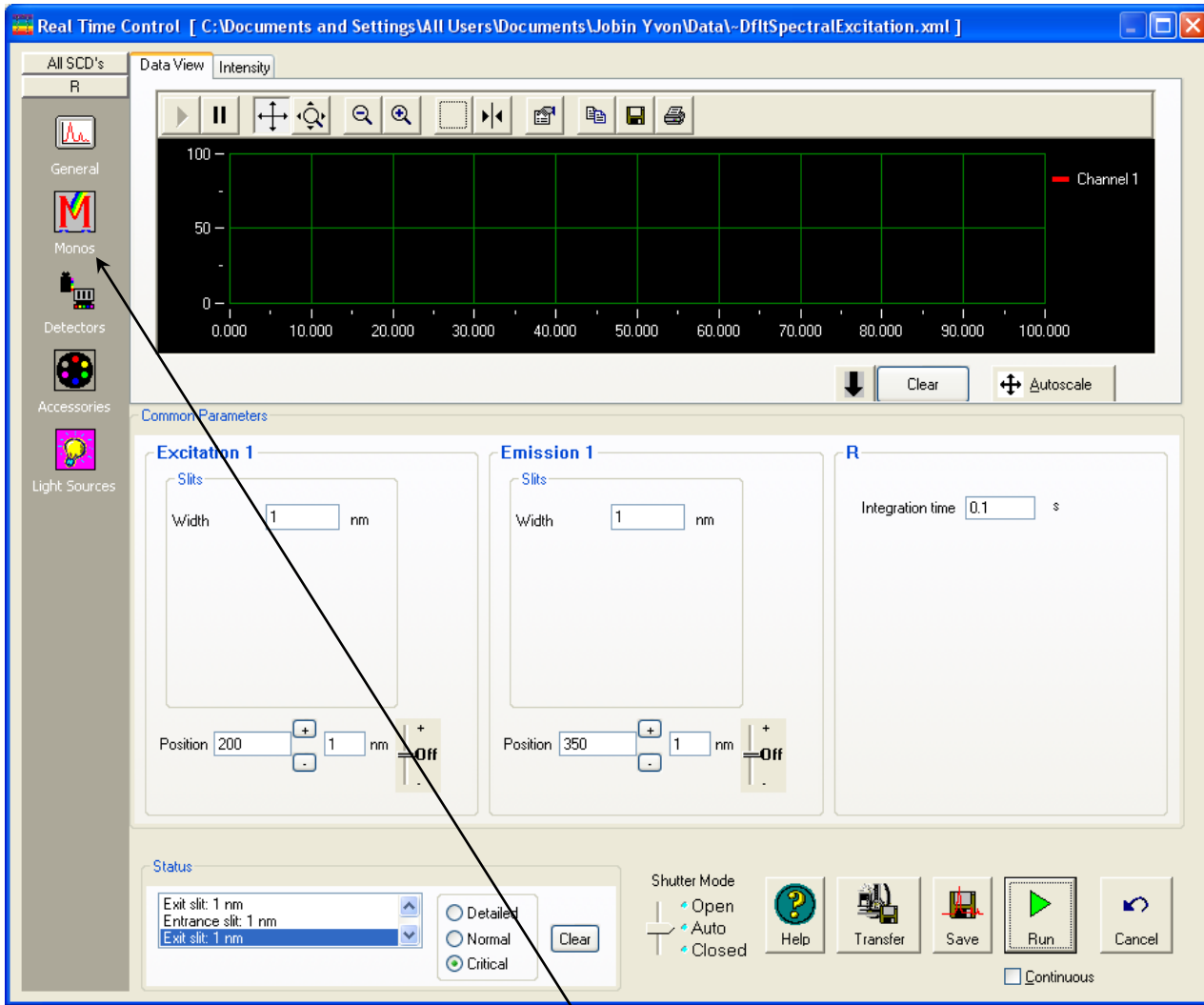

i Click the **Monos** icon  to view the monochromators' index card, then click the excitation monochromator tab:

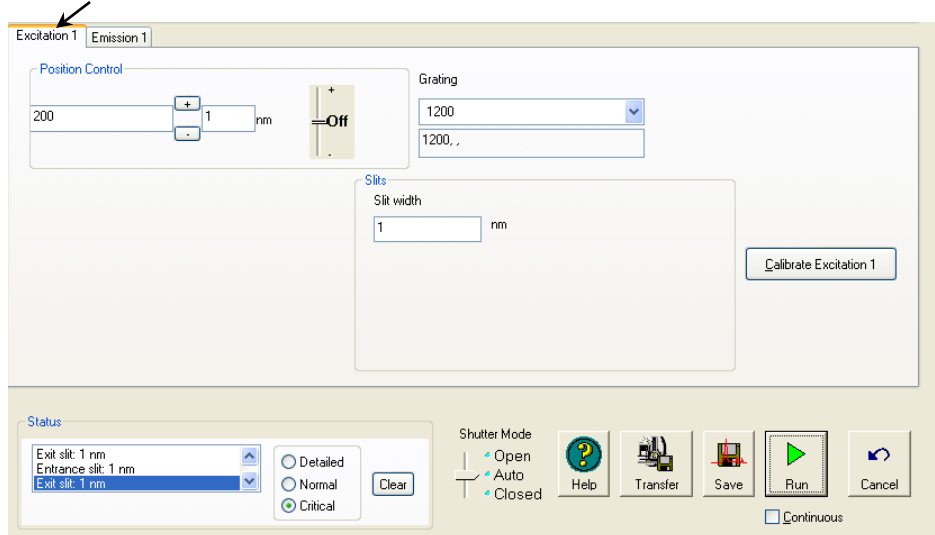



- j Enter the current, observed position (here, 477 nm) of the peak in the **Position Control** field, then hit the Enter key.

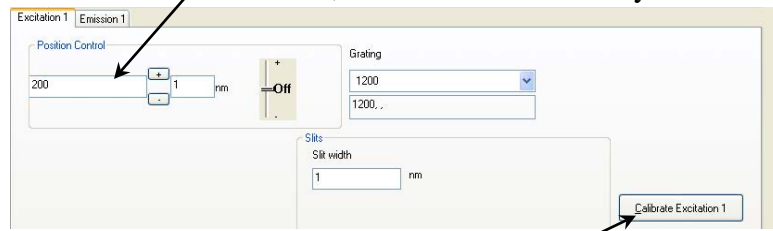

- k Click the **Calibrate Excitation 1** button. The **Calibrate** window opens:

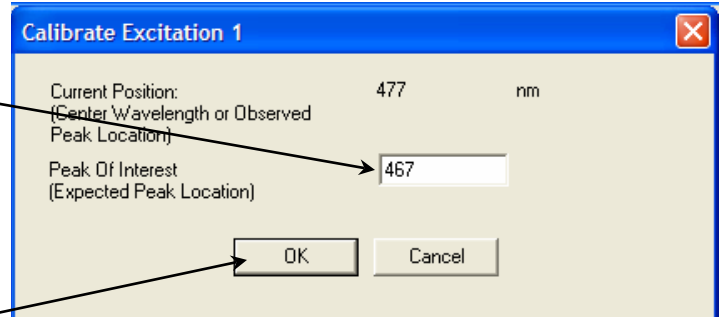

- l In **Peak Of Interest**, enter the actual or expected position of the peak (it ought to be 467 nm).
- m Click the **OK** button.
- n At the bottom right of the **Real Time Control** window, click the **Cancel** button.
- o In the **Experiment** window, click the Run button to confirm the correct peak position. A correct scan is shown below (peak is at 467 nm):

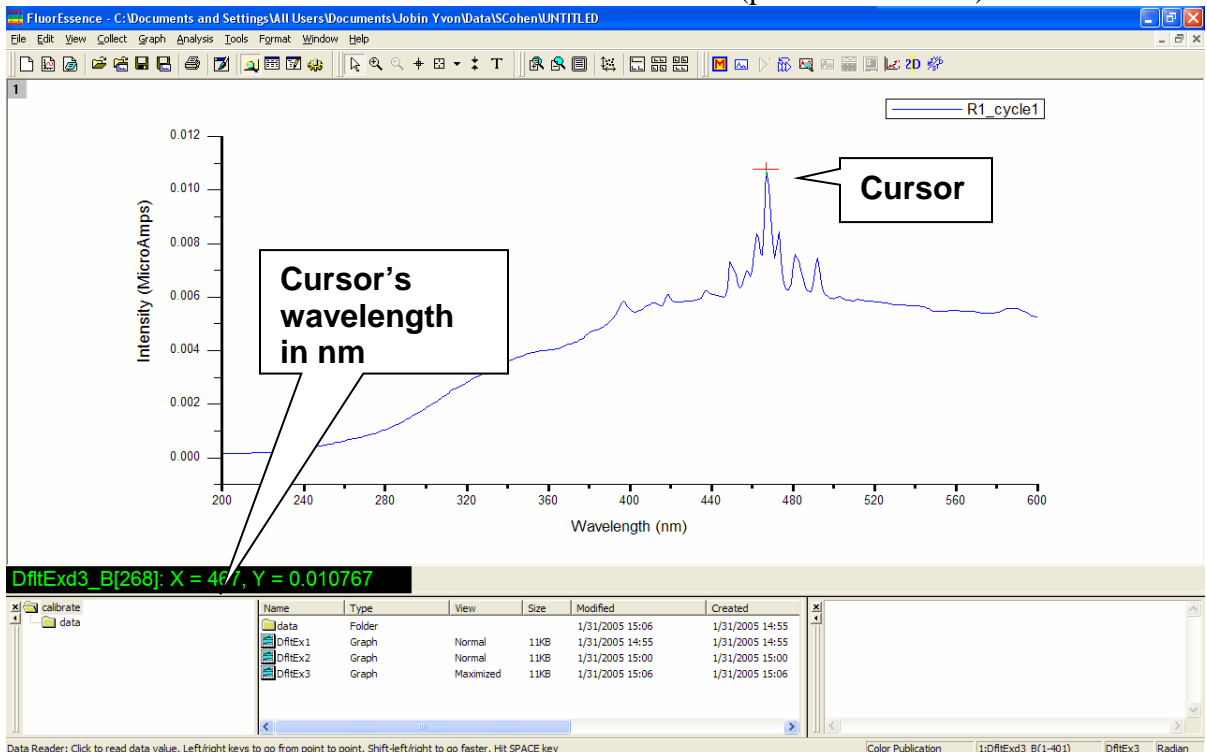

## Emission-monochromator calibration check



**Note:** *The emission-monochromator calibration of the instrument is directly affected by the calibration of the excitation monochromator.*

This calibration check verifies the wavelength calibration of the emission monochromator with the emission photomultiplier tube. It is an emission scan of the Raman-scatter band of water performed in right-angle mode. Perform this check after the xenon-lamp scan. When completed, the performance of the system has been verified.

The water sample should be research-quality, triple-distilled water. HPLC-grade (18-M $\Omega$  spec.) or equivalent water is suggested for the Raman scan. Impure samples of water will cause elevated background levels as well as distorted spectra with (perhaps) some unwelcome peaks.

Use a 4-mL quartz cuvette.



**Note:** *Avoid glass or acrylic cuvettes: they may exhibit UV fluorescence or filtering effects.*

- 1 Insert the water sample into the sample compartment.

With an automated sample changer, note the position number in which the sample cell is placed.

- 2 Close the lid of the sample chamber.

- 3 In the main FluorEssence toolbar, choose the Experiment Menu button :

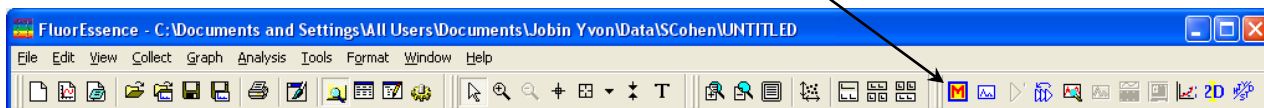

The **Fluorescence Main Experiment Menu** opens.

- 4 Choose Spectra.

The **Experiment Type** window appears:

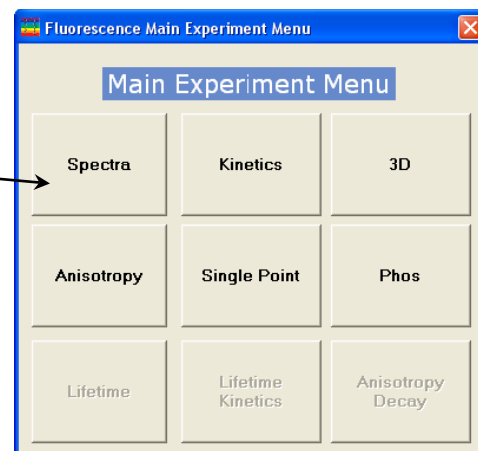

5 Choose Emission, then click the Next >> button.

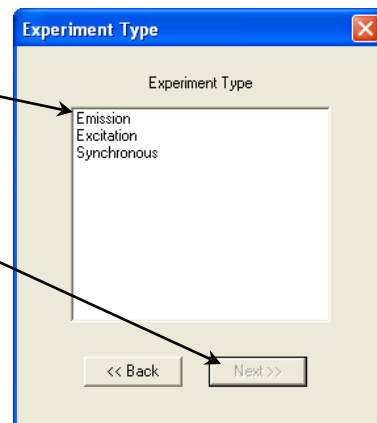

The water-Raman experiment automatically loads.

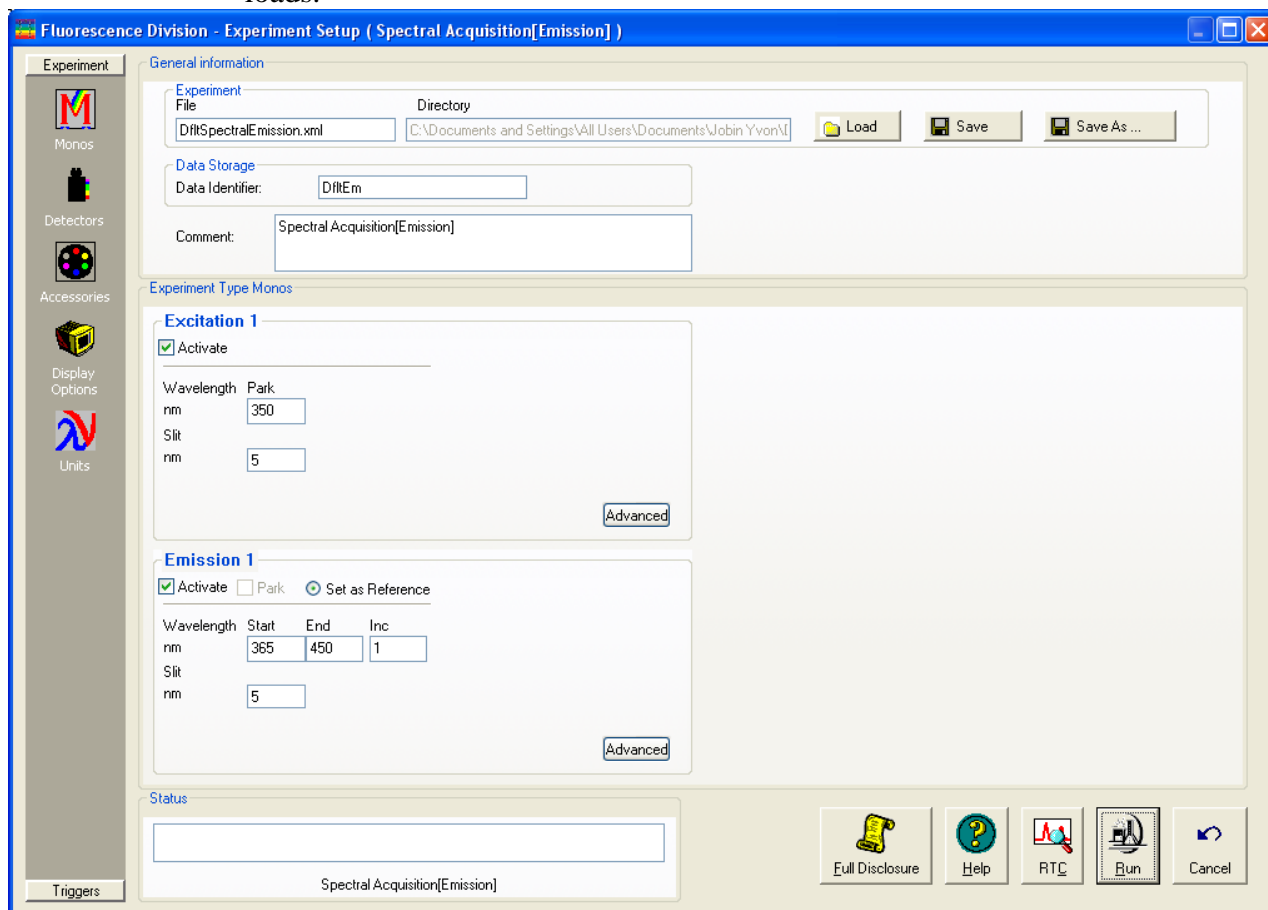

6 Use the default parameters or adjust them.

**Monochromator parameters for the water-Raman scan:**

Monochromator (1200 grooves/mm)	Initial wave-length	Final wave-length	Increment	Slits (band-pass)
Excitation	350 nm	--	--	5 nm
Emission	365 nm	450 nm	1 nm	5 nm

**Detector parameters for the water-Raman scan:**

Detector (Signal)	Integration time	Units
Signal (S1)	0.1 s	CPS (counts per second)

- 7 Click the Run button  in the lower-right corner.

The **Intermediate Display** opens. The water-Raman scan runs.

A new FluoroMax<sup>®</sup> Plus should display a water-Raman peak intensity of at least 400 000 counts s<sup>-1</sup>.



**Note:** Observed throughput (and hence peak intensity) is affected by lamp age and alignment, slit settings, and sample purity. As the xenon lamp ages, the throughput of the system will decline slowly. Therefore, low water-Raman peak intensity may indicate a need to replace the xenon lamp.

- 8 If the water-Raman peak is not at 397 nm, calibrate the emission monochromator as shown for the excitation-monochromator calibration on pages 3-7 to 3-9.

All HORIBA Scientific systems' parameters are specified with a R928P photomultiplier tube at room temperature.

## Calculation of water-Raman signal-to-noise ratio

### Introduction

The water-Raman test is a good measure of relative sensitivity between different instruments, if the experimental conditions used to compare the systems are the same. Unfortunately, there are different ways of handling the data, all of which are valid but which will give quite different values. Therefore, it is important not only to know how the water-Raman  $S/N$  values are measured, but also how the data were treated. The water-Raman  $S/N$  test method combines a value for system sensitivity (a signal) with a value for system noise (no signal) to show the overall performance of the instrument.

### Definitions

At HORIBA Scientific, we define the  $S/N$  ratio as the difference of peak and background signal, divided by the square root of the background signal.

$$\frac{S}{N} = \frac{S_{peak} - S_{background}}{\sqrt{S_{background}}} \quad \text{Our method}$$

The peak signal is measured at the water-Raman peak (397 nm for 350 nm excitation) and the noise in a region (450 nm) where no Raman signal is present. An “ideal” system would give a signal value of zero at 450 nm. Thus the equation becomes

$$\frac{S}{N} = \frac{S_{397\text{ nm}} - S_{450\text{ nm}}}{\sqrt{S_{450\text{ nm}}}}$$

Another commonly used method is to divide the difference (peak signal minus background signal) by the rms value of the noise on the background signal. This second method is used by a few other manufacturers:

$$\frac{S}{N} = \frac{S_{peak} - S_{background}}{N_{\text{rms,background}}} \quad \text{Other manufacturers' method}$$

### Example

Some actual data from a typical FluoroMax<sup>®</sup> Plus system serve to show the difference between the two methods. The experimental conditions were:

Excitation	350 nm, 5 nm band-pass	Increment	0.5 nm
Emission	365–450 nm, 5 nm bandpass	Integration time	0.5 s
Data-handling	No smoothing	Detector	Standard room-temperature, red-sensitive



**Note:** Make sure the test is carried out with the actual detector used.

All HORIBA Scientific systems' parameters are specified with a R928P photomultiplier tube at room temperature.

## Results

The measurements provided the following spectrum and data:

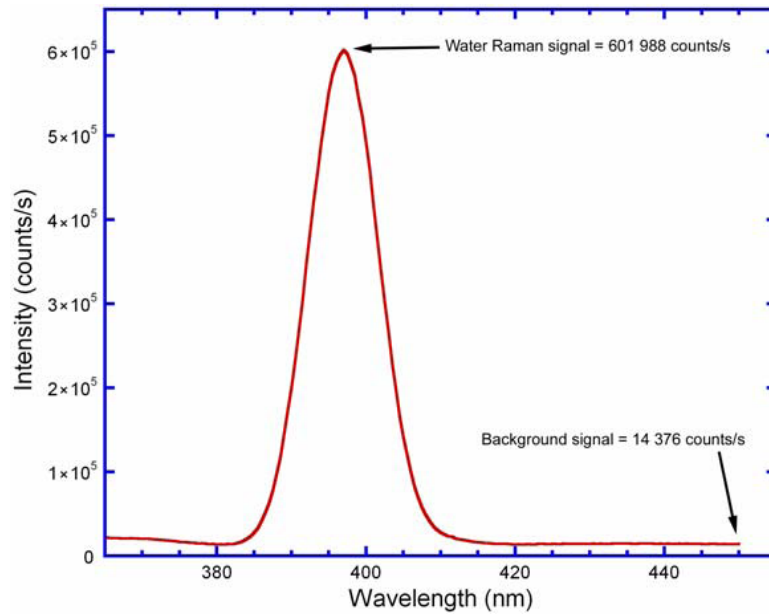

$S_{peak}$	(peak signal at 397 nm)	601 988 cps
$S_{background}$	(background noise at 450 nm)	14 376 cps
$N_{p-p}$	(Peak-to-peak noise of background at 450 nm*)	405 c

\*Measured with a separate kinetic scan

$N_{p-p}$  gives an rms noise of the background signal equal to

$$N_{rms,background} = \frac{405}{5} = 81$$

## Comparison

The HORIBA Scientific method gives a water-Raman  $S/N$  of

$$\begin{aligned} \frac{S}{N} &= \frac{S_{peak} - S_{background}}{\sqrt{S_{background}}} \\ &= \frac{601\,988 - 14\,376}{\sqrt{14\,376}} \\ &= 4901 \end{aligned}$$

The other method similarly gives a water-Raman  $S/N$  of

$$\begin{aligned} \frac{S}{N} &= \frac{S_{peak} - S_{background}}{N_{rms,background}} \\ &= \frac{601\,988 - 14\,376}{81} \\ &= 7254 \end{aligned}$$

We assert that our method is correct, although it gives a lower value. The second method only takes into account the detector noise and the shot noise of the electronics. On the other hand, by using the background total intensity as a measure of noise, our method is more representative of a real “live” experiment where noise is also influenced by factors such as the quality of the optics and scattered light in the system. These additional factors influence the ability to measure a very low signal from a sample and ought not be ignored.

## Notes on excitation and emission calibration

- HORIBA Scientific recommends monitoring the number of hours of xenon-lamp use.
- Additionally, you may want to record the water-Raman intensity daily or weekly.
- The lamp is rated for 1200–1500 h, but if the Raman intensity starts to drop, you may wish to change the lamp sooner.

# Switching to the other detector

To use the second, external detector, you must reinitialize the system with a FluoroMax® Plus configuration.

- 1 In the toolbar, choose Collect.  
A drop-down menu appears.
- 2 Choose Advanced Setup.  
Another drop-down menu appears.
- 3 Choose System Reinitialization.

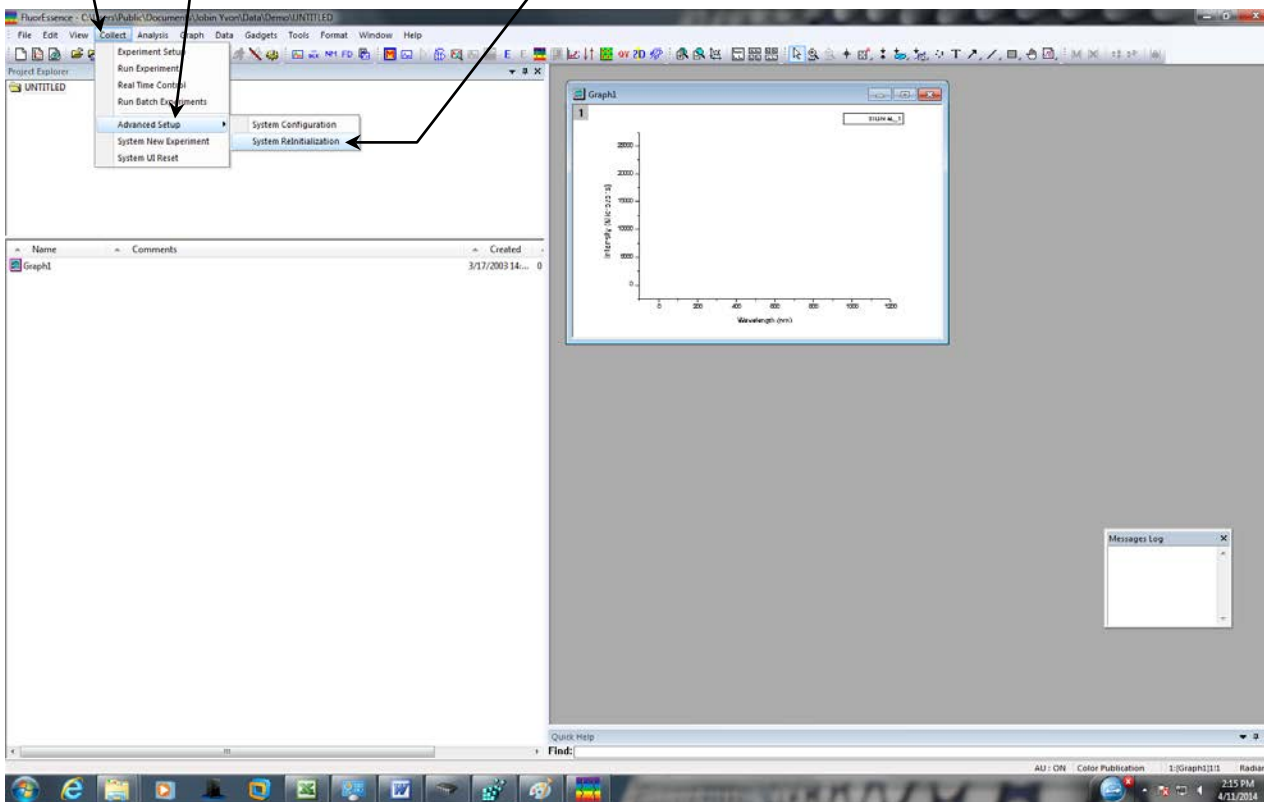

The Select Hardware Configuration window appears.

- 4 Choose the desired detector from the list, then click the OK button.

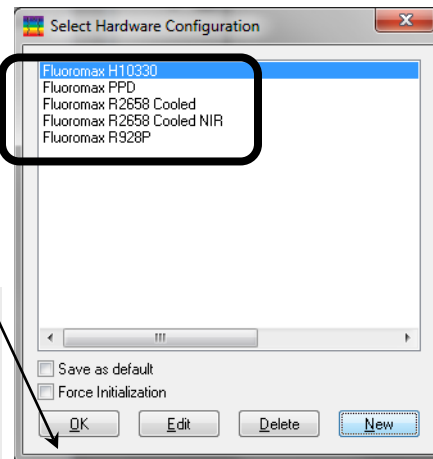

**Note:** The default internal detector is the R928P. Your external detector will be one of these others also listed.



# 4 : Data Acquisition

## Introduction to FluorEssence<sup>™</sup> and Multigroup

This chapter presents an introduction to some of the special buttons used in FluorEssence<sup>™</sup> to record and present data with the FluoroMax<sup>®</sup> Plus series. These buttons, located in FluorEssence<sup>™</sup>'s main window, are:

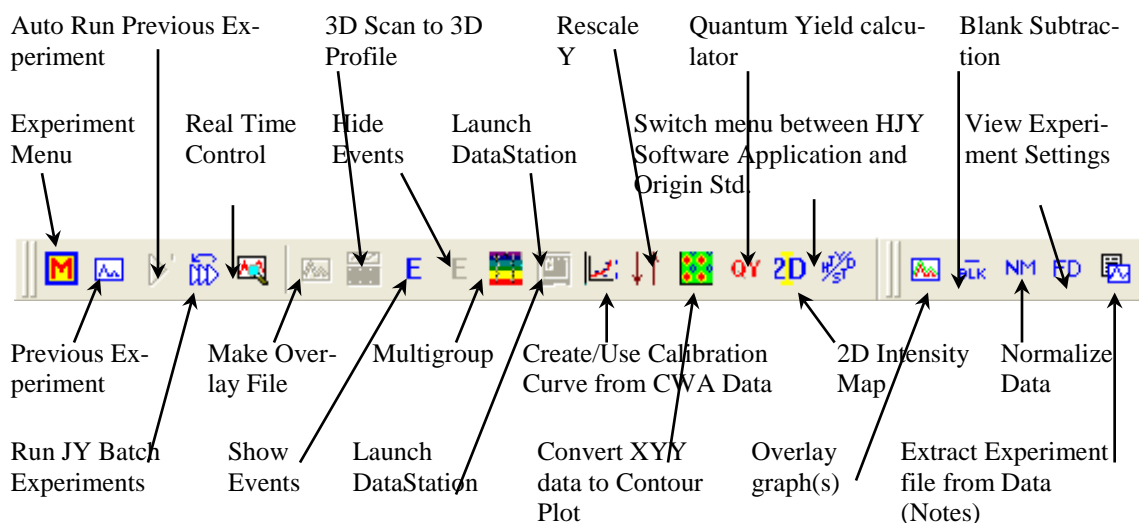

For a detailed description of these FluorEssence<sup>™</sup> routines, see the *FluorEssence<sup>™</sup> User's Guide* and on-line help.

A second program, called Multigroup, offers repeated and sequential fluorescence experiments. Functions such as delays, temperature ramps, ratiometric probes such as Fura-2, and multiple samples and wavelength-groups are allowed within Multigroup. You can start Multigroup from within FluorEssence<sup>™</sup>, or from a Windows<sup>®</sup> desktop icon.

In addition, methods for determining best excitation and emission wavelengths are presented, in case these wavelengths are unknown for the sample.

# Experiment Menu button

The **Experiment Menu** button chooses an overall type of experiment to run, such as an emission scan, a phosphorimeter scan, a synchronous scan, etc., based on the instrument and connected accessories, such as a temperature bath, MicroMax, etc. Only those scans that can be run using the available hardware configuration are active; scans that cannot be taken are grayed out.

Calibration scans for the FluoroMax® Plus use default parameters:

- Excitation monochromator: Spectra/Excitation scan
- Emission monochromator: Spectra/Emission scan

1 To choose an experiment type, click the Experiment Menu button :

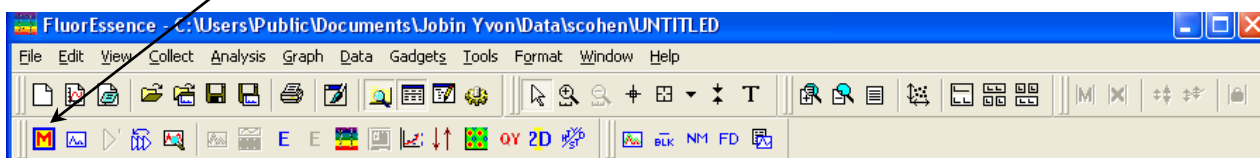

The Fluorescence Main Experiment



**Note:** Certain scan types are not allowed with the FluoroMax® Plus, and are grayed out.

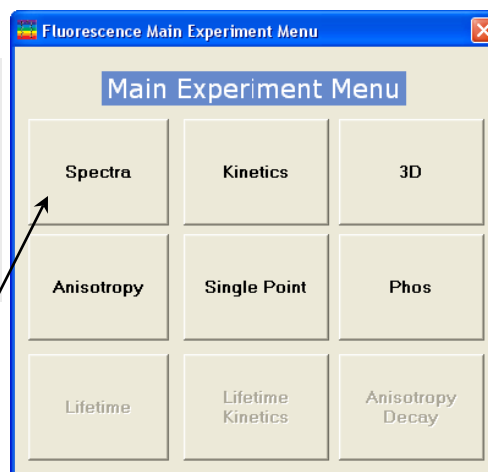

Menu appears:

2 Choose an experiment type.

The **Experiment Type** window appears.

3 Choose a subtype of experiment, and click the Next >> button.



**Note:** Some experiment types (for example, Kinetics) do not have subtypes, so no Experiment Type window appears.

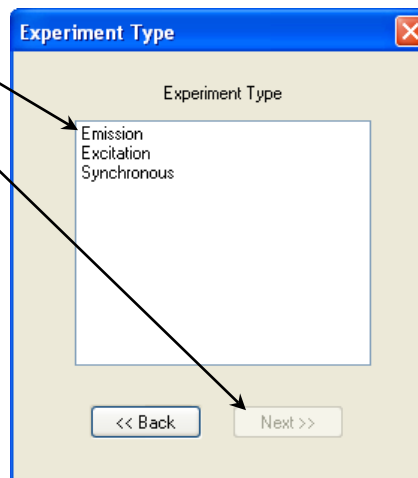

The **Experiment Setup** window appears:

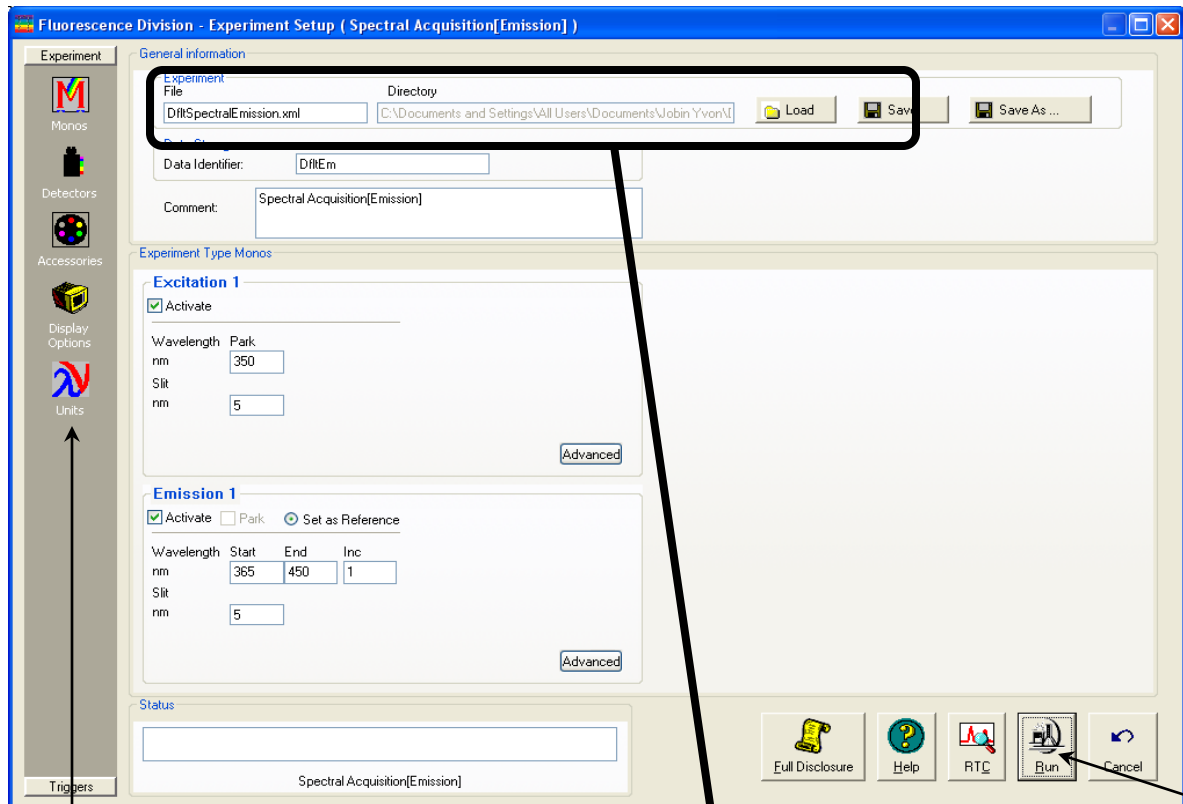

4 Click the Experiment File field, and enter a new file name or select a previously saved file.

5 Verify that experimental parameters are correct.

Be sure to check all parameters under all icons in the left-hand column.

6 Insert the sample into the sample compartment, and close the sample compartment's cover.

7 Click the Run button .

The collected spectrum is displayed on the **Intermediate Display** screen. After all data are recorded, the **Intermediate Display** vanishes. For a new project, the **Project Name** window appears:

8 Enter a name for the entire project, or browse for an existing project name via the Browse button, then click the OK button.

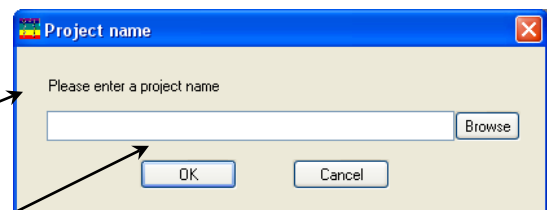

All data are moved to Origin<sup>®</sup>'s graph window for post-processing.

# Previous Experiment Setup button

The Previous Experiment Setup button resets the experiment to the previous experiment used, with minor modifications to the hardware possible.



**Note:** The Previous Experiment Setup button is active only after an experiment already has been loaded.

- 1 After an experiment is loaded, click the Previous Experiment Setup button  in the main toolbar:

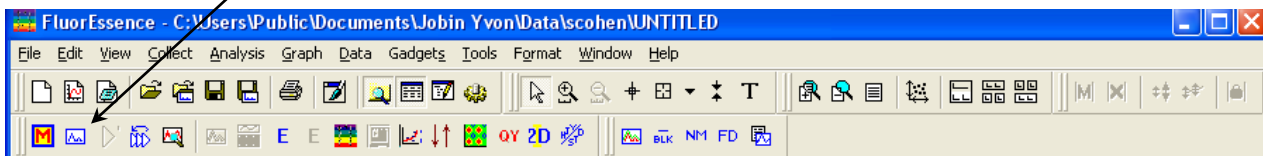

The last experiment used or loaded appears in the Experiment Setup window:

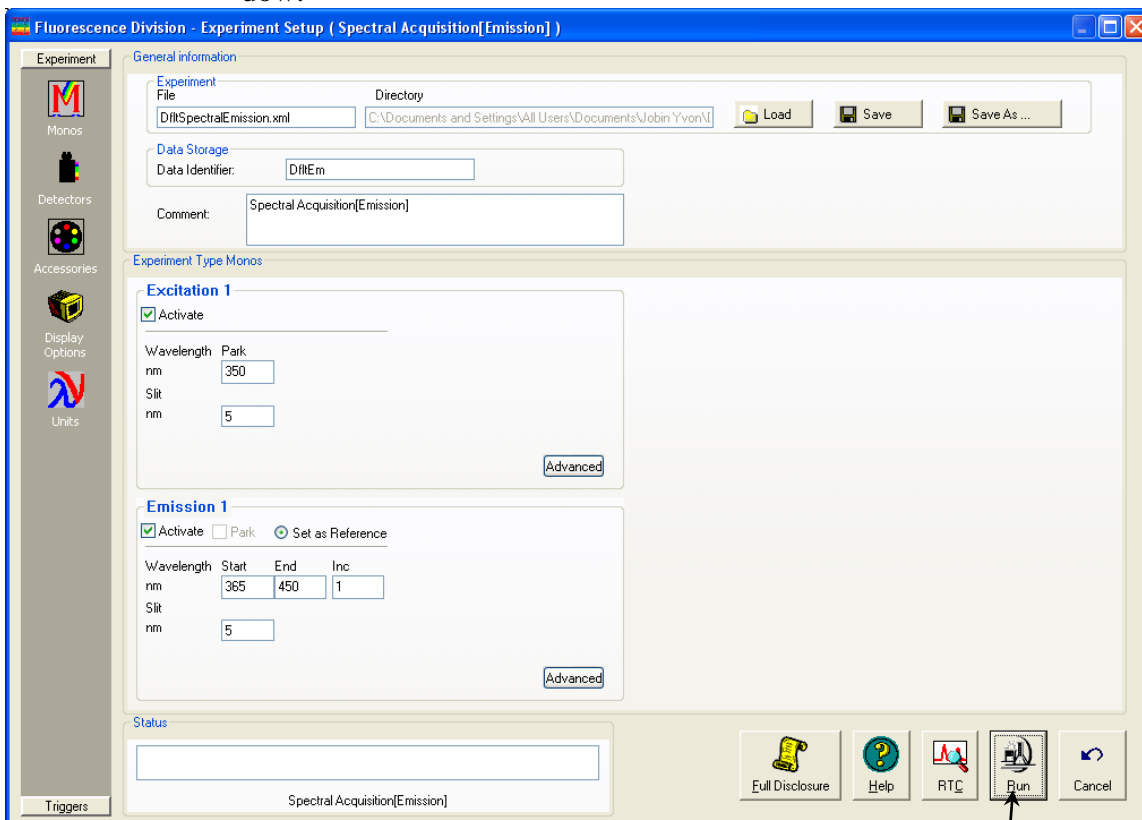

- 2 Modify the experiment's parameters as required.

- 3 Click the Run button  to run the experiment.

# Auto Run Previous Experiment button

The **Auto Run Previous Experiment** button reruns the last experiment loaded without modifications.

 **Note:** The Auto Run Previous Experiment button is active only after an experiment has already been loaded and run.

## 1 Click the Auto Run Previous Experiment button

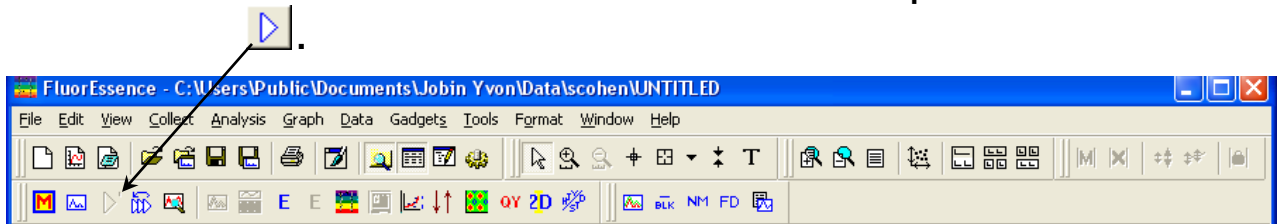

The **Intermediate Display** appears, and the experiment starts:

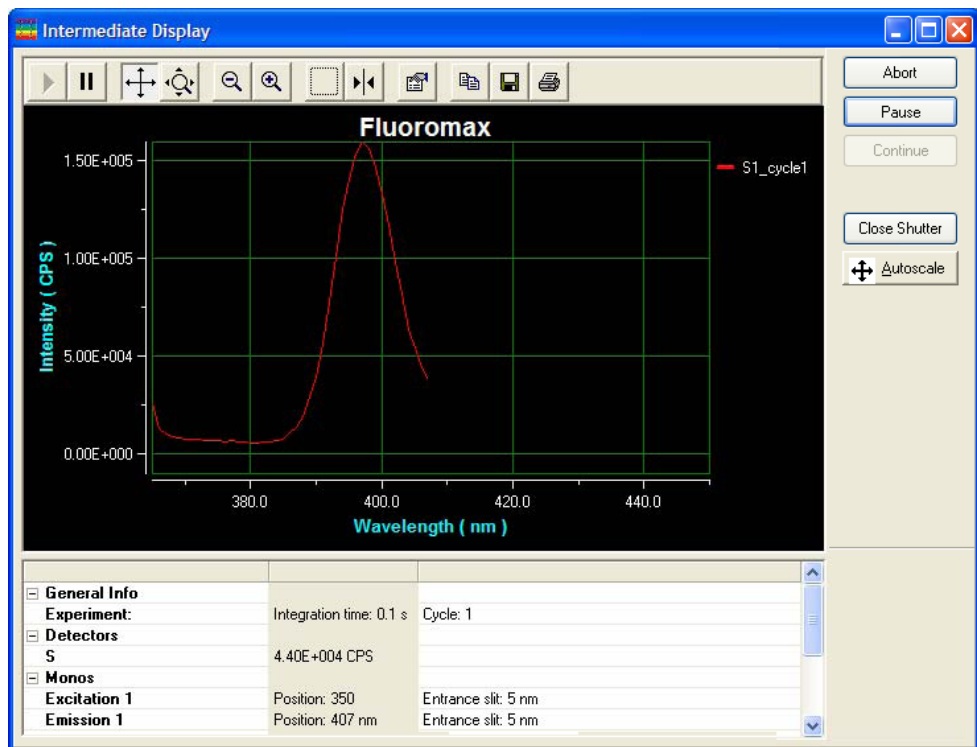

When the experiment is complete, the data are moved into a new Origin® graph window:

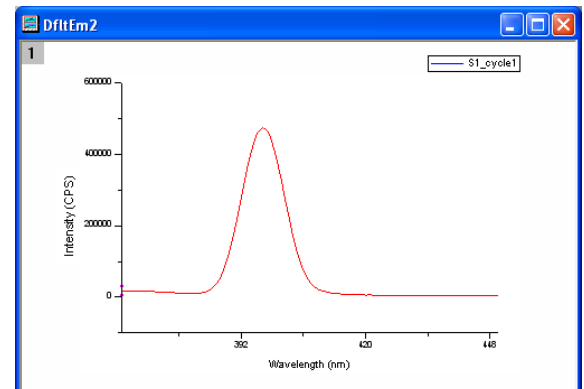

# Make Overlay File button

The **Make Overlay File** button creates an \*.SPC file for use as an overlay file. An overlay file can be used to compare data in real time. Inclusion of an overlay file is controlled in the **Display Options** icon in the **Experiment Setup** window. The overlay file appears in the **Intermediate Display** as data are acquired. Upon completion of the acquisition, both sets of data appear on the plot.

- 1 Click the Make Overlay File button in the toolbar.

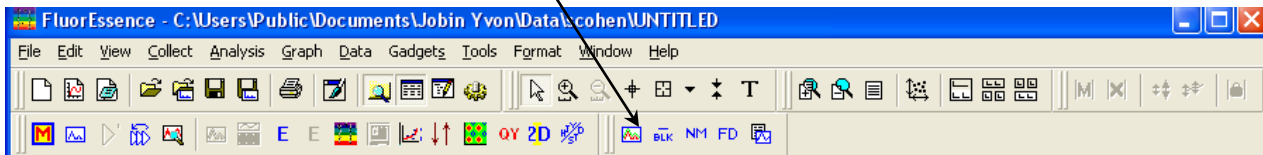

- 2 Enter a file name in the File name field.
- 3 Click the Save button.  
The overlay file is saved.

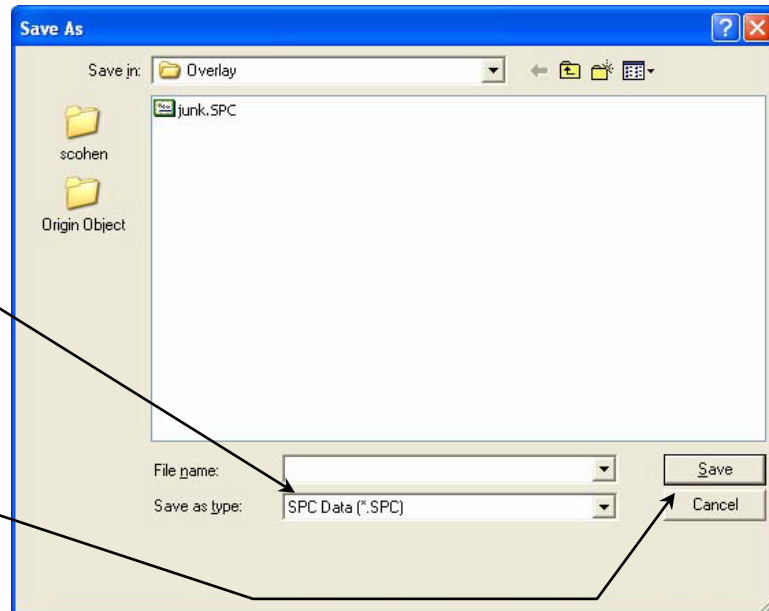

## 3D Scan to 3D Profile button

The **3D Scan to 3D Profile** button extracts emission profiles from an excitation-emission matrix.

- 1 Open excitation-emission matrix data.
- 2 Click the 3D Scan to 3D Profile button in the toolbar.

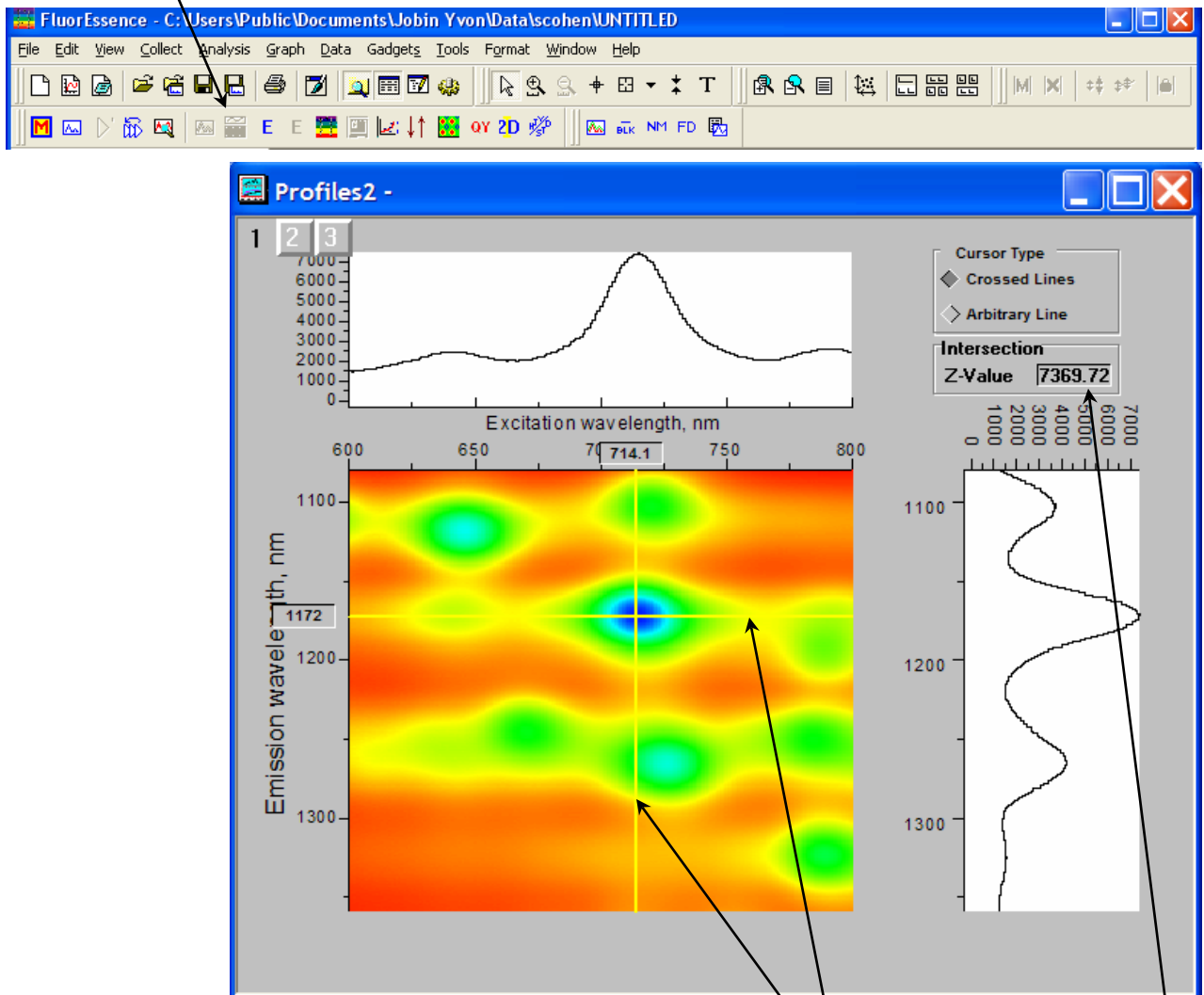

The **Profiles** window appears.

- 3 Grab and move the emission and excitation profile lines to see the profiles above and to the right of the data-matrix.

The **Z-Value** field shows the intensity where the excitation and emission profiles intersect.

- 4 Click the Arbitrary Line button to choose an arbitrary profile.

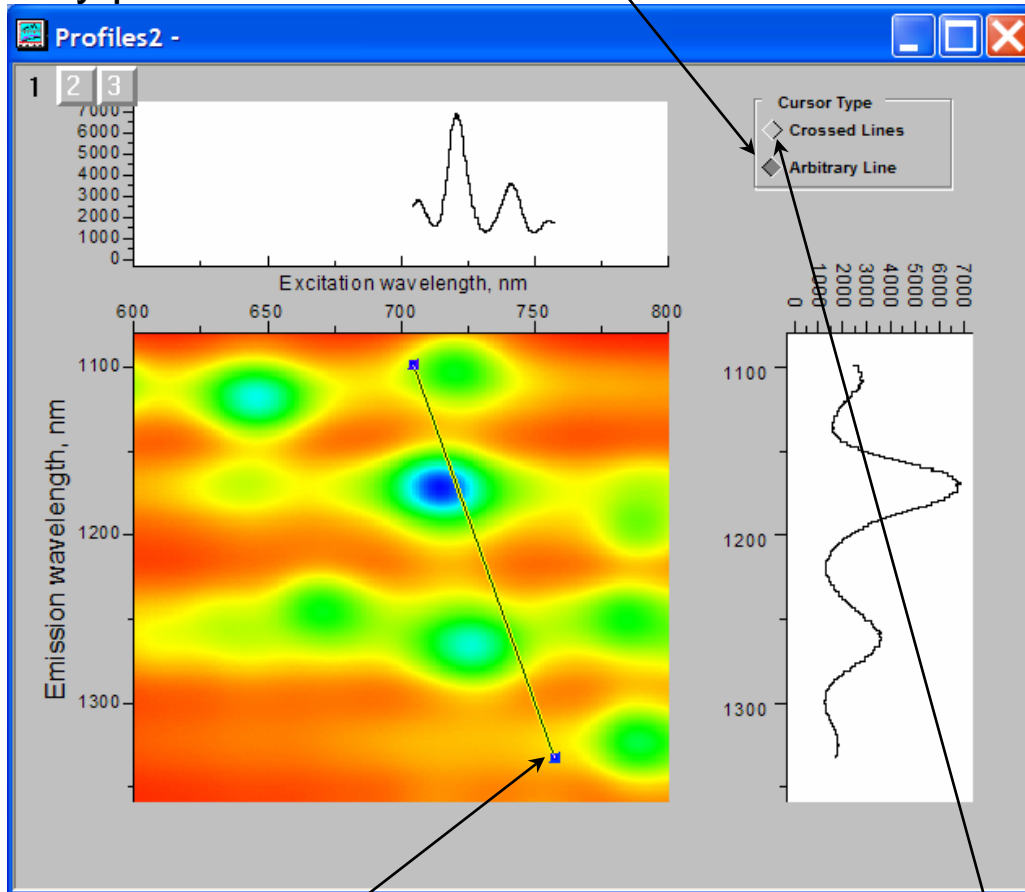

Grab an end of the profile line and move to the desired location on the matrix. The profiles are updated.

- 5 To return to perpendicular profiles, click the Crossed Lines button.



# Run JY Batch Experiments

The **Run JY Batch Experiments** button runs a series of automated experiments, including adjustable repeats and delays between experiments.

1 Click the Run JY Batch Experiments button .

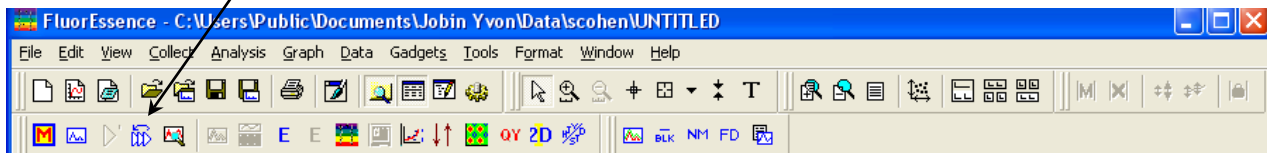

The **Setup batch experiments** window appears.

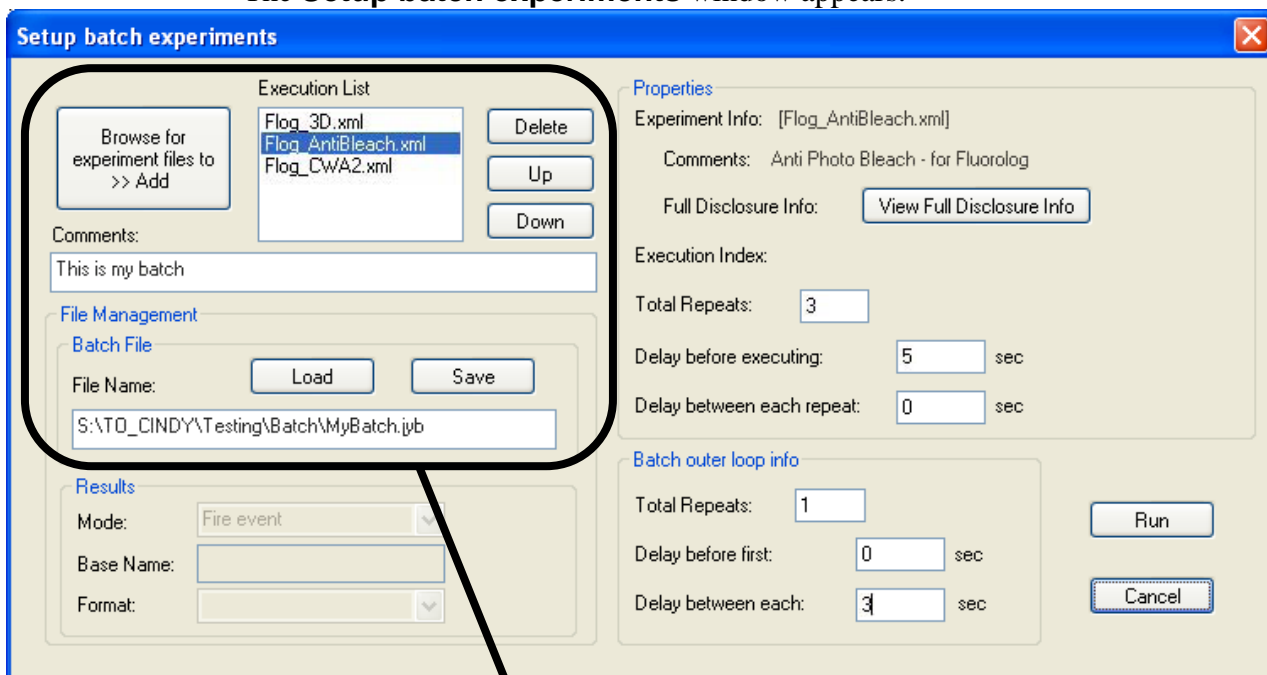

2 Get the experiment files to create a batch job, or load a previous batch job.

- a Load a previously created batch job using the **Load** button, or browse for experiment files (.xml format) using the **Browse for experiment files to >> Add** button.
- b Add each desired experiment file to the **Execution List**.
- c Reorder or remove the files as necessary using the **Delete** button, the **Up** button, and the **Down** button.
- d Add comments about the batch file in the **Comments:** field.
- e Save the new batch job in the correct path, in the **File Name:** field, and click the **Save** button.  
The file is saved in a .jyb format.

3 Set up each experiment in the batch job.

- a Select an experiment from the **Execution List**.
- b In the **Total Repeats:** field, enter the number of times that experiment should be repeated.

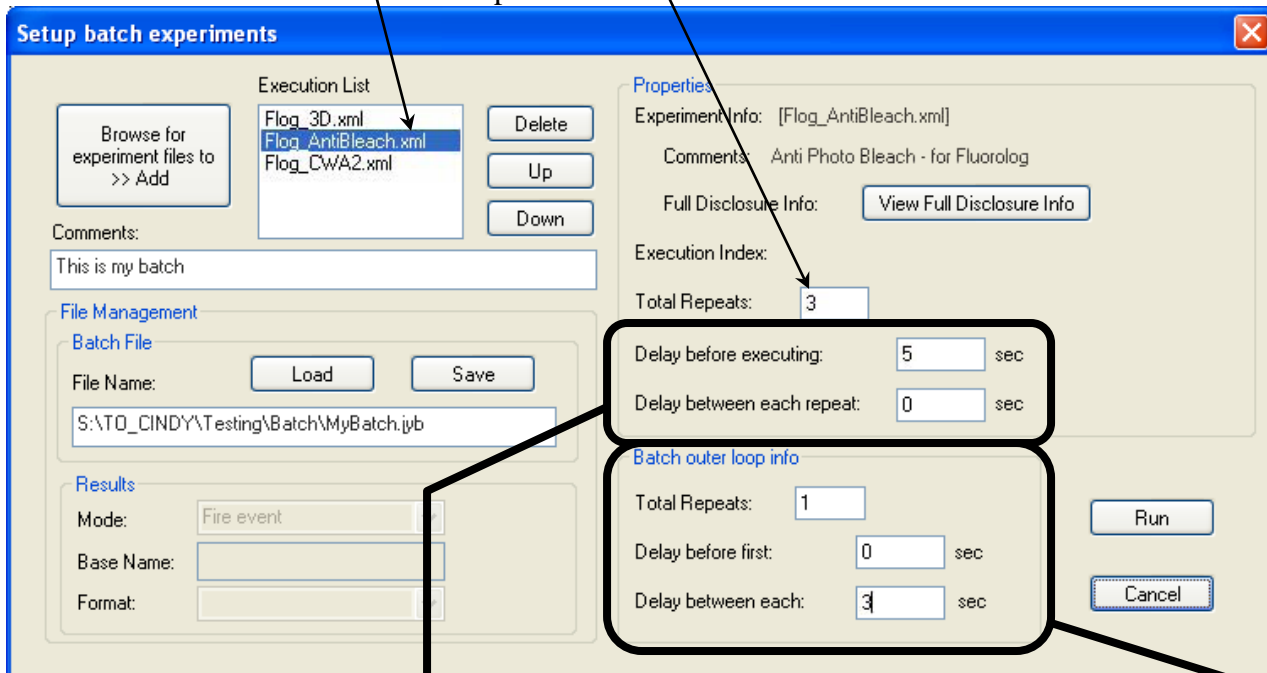

- c In the **Delay before executing:** field, enter the number of seconds to wait before executing.
- d In the **Delay between each repeat** list: field, enter the number of seconds to wait before repeating the experiment.

#### 4 Set up an outer loop in the batch job, if desired.

- a In the **Total Repeats:** field, enter the number of times to run the batch job.
- b In the **Delay before first:** field, enter the number of seconds to wait before starting the batch job.
- c In the **Delay between each:** field, enter the number of seconds to wait before rerunning the batch job.

#### 5 Click the Run button to start the batch job.

The batch job executes.

# Real Time Control

The **Real Time Control** button opens the **Real Time Control** window directly, so that the user can adjust experimental parameters in real time, while viewing effects of the adjustments.

1 In the toolbar, click the Real Time Control button

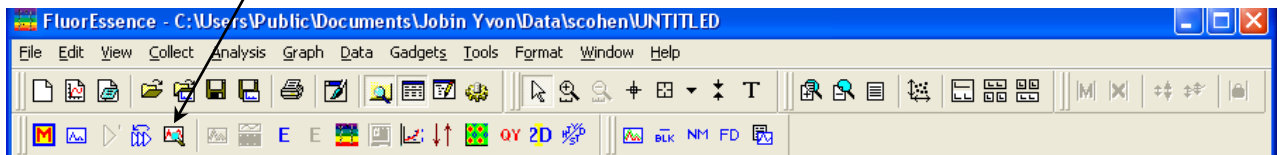

The **Real Time Control** window appears:

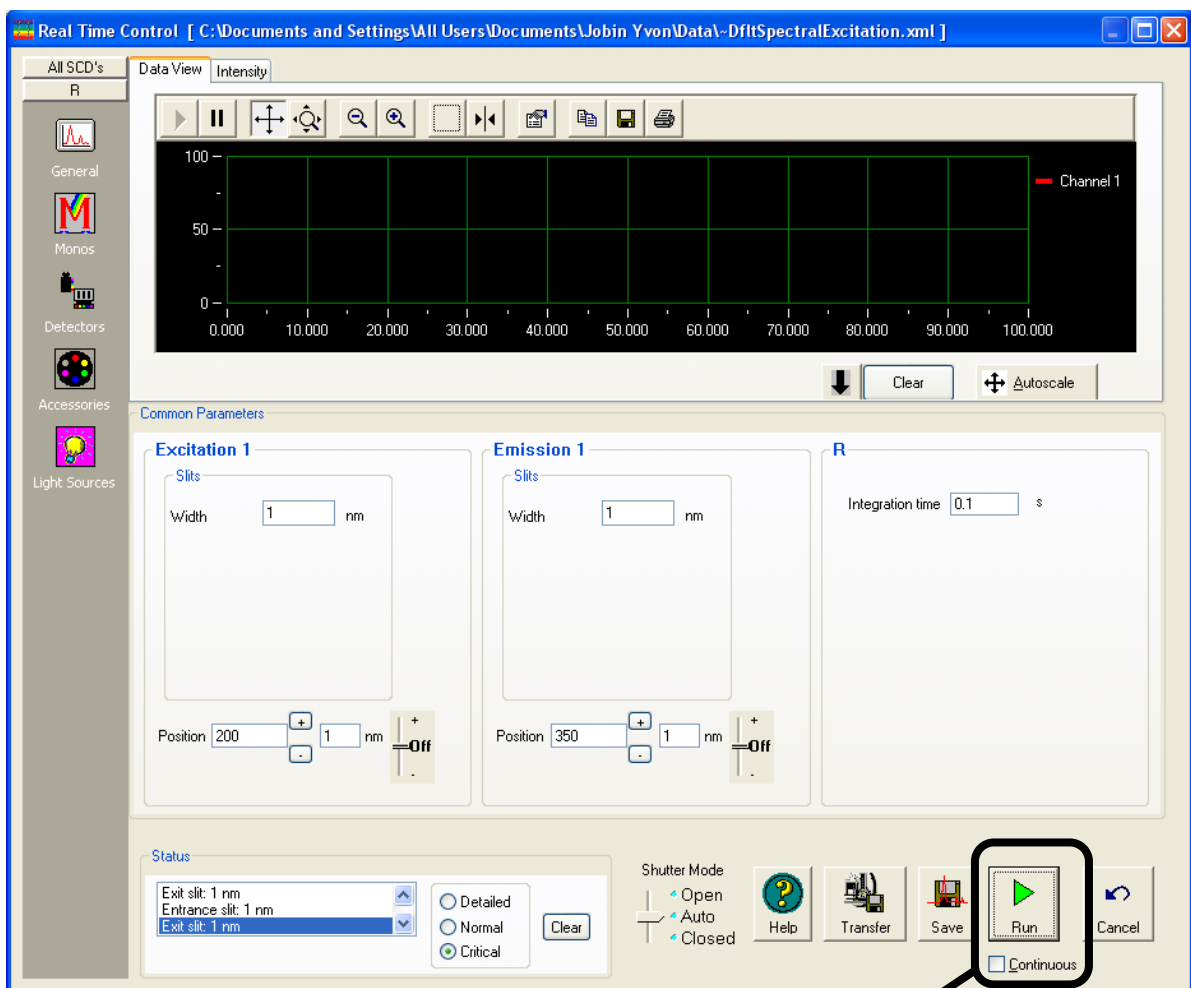

2 Activate the Continuous checkbox, then click the Run button, to monitor the signal.

3 Adjust instrumental parameters as necessary.

# Create/Use Calibration Curve from CWA Data

When the user is doing **Single Point** experiments (especially with the MicroMax or multiple-sample changers), the **Create/Use Calibration Curve from CWA Data** button creates a calibration curve for analytical measurements.



**Note:** This button only operates if CWA data exist.

## 1 Click the Experiment Menu button :

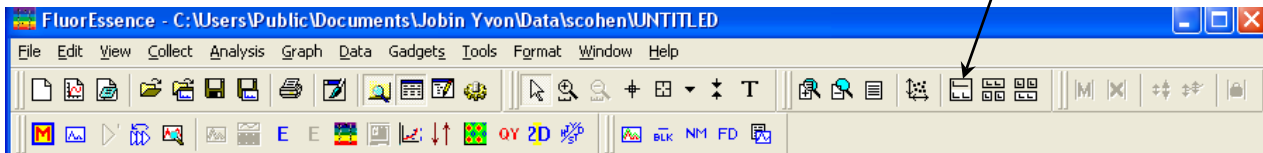

The Fluorescence Main Experiment Menu appears:



**Note:** Those scan types not allowed with the instrument configuration are grayed out.

## 2 Choose the Single Point button.

The **Experiment Setup** window appears:

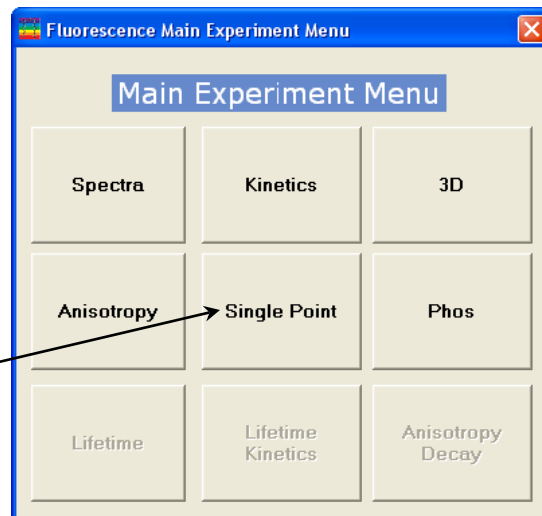

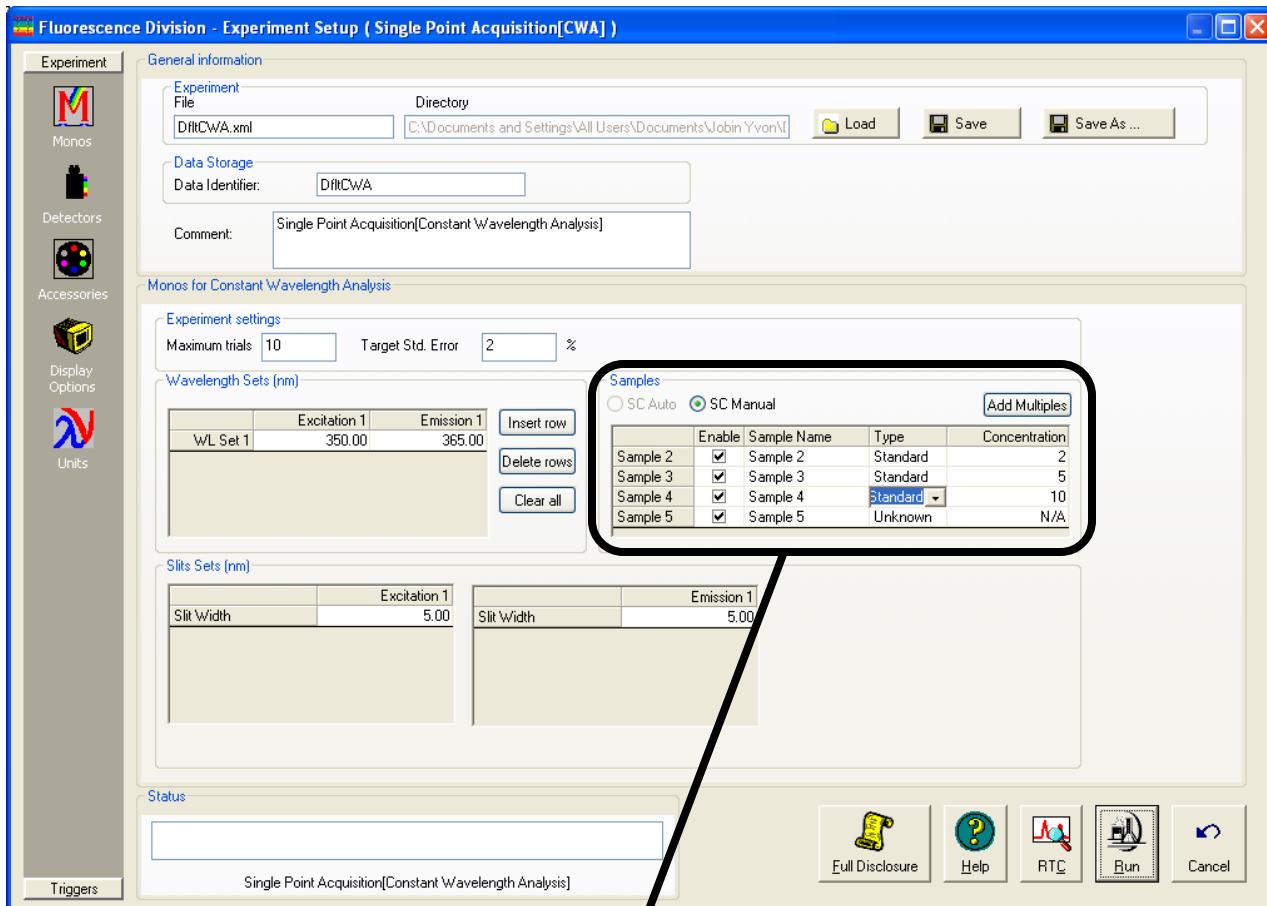

### 3 Set up the standards and unknown(s).

- a If you have an automatic sample changer, you can change the samples automatically with the **SC Auto** radio button. For manual use with an automatic sample changer, choose **SC Manual** radio button, and the software prompts you to change the sample. This allows more than the default number of samples in the sample changer (i.e., more than 2 for the dual sample-changer or more than 4 for the four-sample-changer).
- b To add more samples (if manually changed), click the **Add Multiples** button. A new sample row appears below the last sample row.
- c Under the **Type** column, choose the type of sample from the drop-down menu: **Standard, Unknown, Blank, or Empty**.
- d Enter the concentrations of the standards in the **Concentration** column. The unknowns retain the default “N/A” concentration.
- e Click the **Enable** checkbox of all the samples to be measured.

- 4 Set up the excitation and emission wavelength(s).
  - a Enter the appropriate excitation and emission wavelength set(s), one per row, in the **Wavelength Sets** area.
  - b To add a wavelength set, click the **Insert row** button.
  - c To delete a wavelength set, select the rows, and click the **Delete rows** button.
  - d To clear all wavelength sets, click the **Clear all** button.

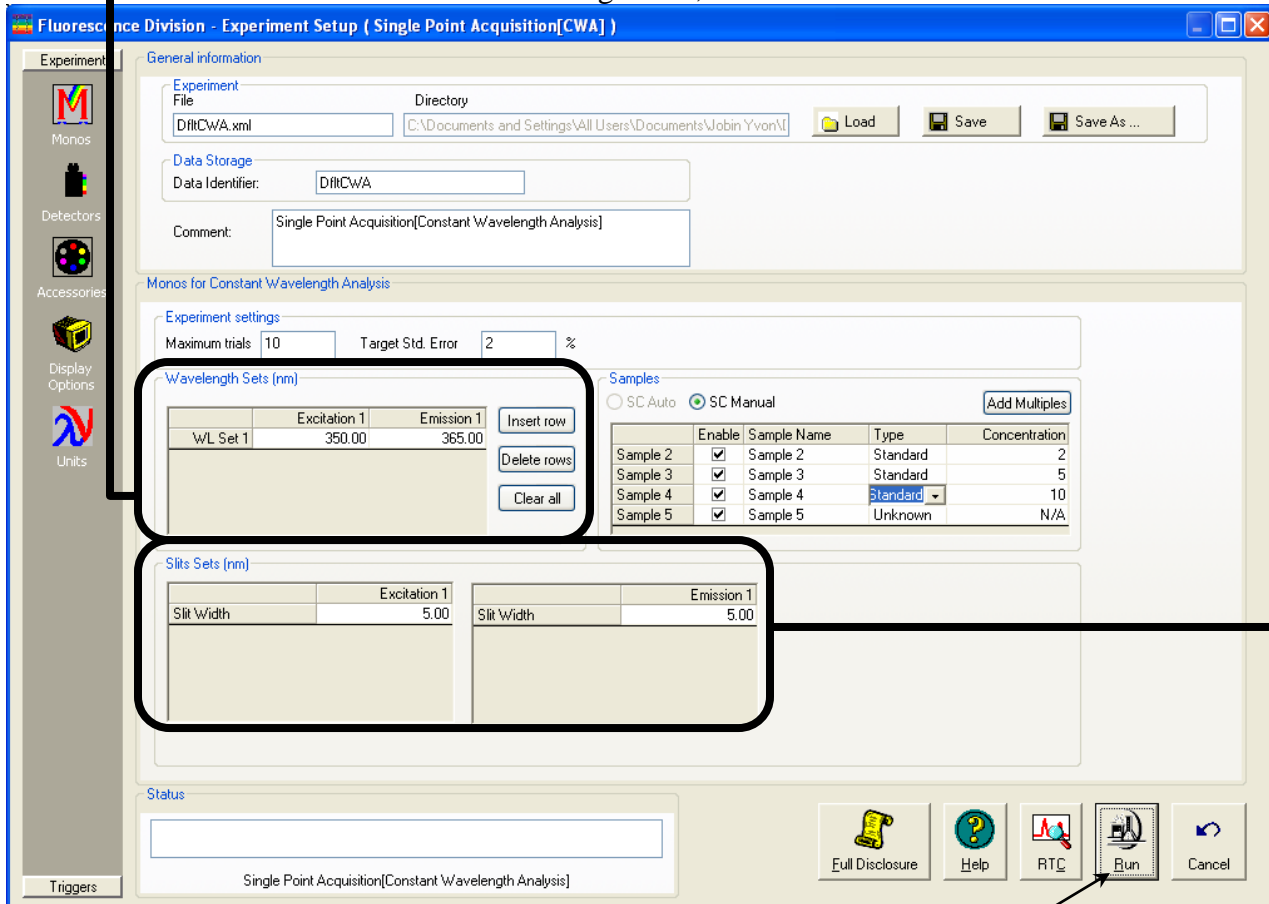

- 5 Enter the excitation and emission slit-width(s) in the Slit Sets area.

- 6 Click the Run button .

The experiment starts. FluorEssence™ prompts you to insert the sample, if you chose to change the samples manually. The dataset is recorded and appears on the screen.

- 7 Create the calibration curve.

a Click the **Create/Use Calibration Curve from CWA Data** button in the toolbar.

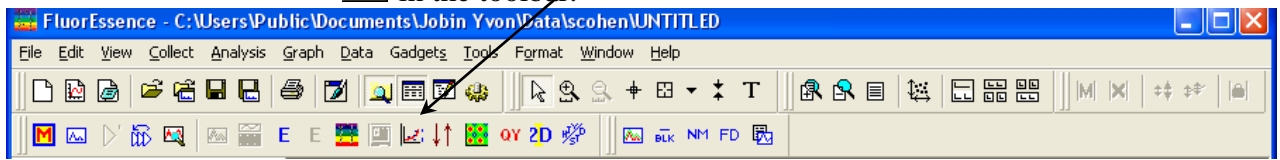

The **Calibration Curve**

**Parameters** window appears.

b Choose a **Linear** fit, or a **Polynomial** fit with **Order** of the polynomial, and then the **OK** button.

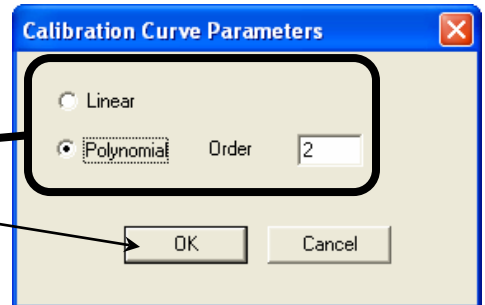

The Save Curve window asks if you wish to save the curve.

c Answer yes or no. The calibration curve appears.

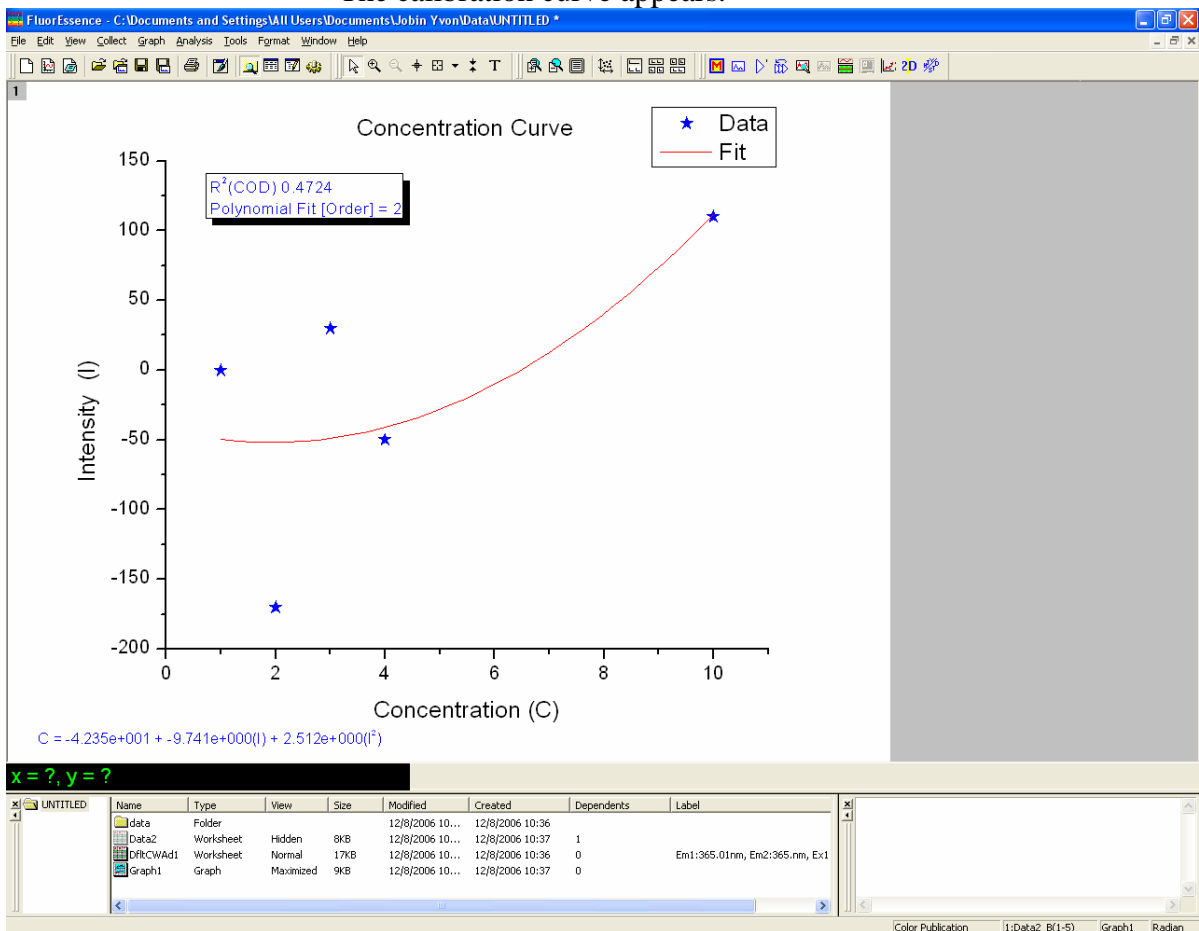

Stars indicate the standards. The unknowns are not plotted, but their calculated concentrations are filled in on the dataset. The fit equation and correlation are displayed on the plot. With more than one detector signal (e.g., S1 or S1c), the software prompts you to choose which signal.

# 2D Intensity Map

The **2D Intensity Map** button creates a two-dimensional intensity map from the active microscope-mapping data.



**Note:** This button only operates if data are displayed, and is used for microscope mapping purposes.

## 1 Open a microscope-mapping dataset.

The screenshot shows the FluorEssence software interface. The main window displays a 3D intensity map plot with the following axes and labels:

- Y-axis:** Intensity (CPS), ranging from 0 to 20000.
- X-axis:** Wavelength (nm), ranging from 400 to 550.
- Z-axis:** Intensity (Undefined).

The plot shows a red surface representing the intensity map. Several data points are labeled with coordinates: (867,249), (596,339), (957,407), (687,497), and (1048,565). The software title bar indicates the file path: C:\Documents and Settings\scohen.WINNT\Desktop\beads 15um ex 360. The bottom area shows a file explorer window with a table of files:

Name	Type	View	Size	Modified	Created	Dependents
data	Fol...				2/17/...	11/17/2008 17:01
DfItEm1	Gr...	No...	1...	11/17/...	11/17/...	0
DfItEm2	Gr...	No...	9KB	11/17/...	11/17/...	0
DfItEm3	Gr...	No...	1...	11/17/...	11/17/...	0
DfItEm4...	Gr...	No...	1...	11/17/...	11/17/...	0

An arrow points from the 'data' folder in the file explorer to the '2' step instruction below.

## 2 Click the data folder in bottom area.

The data spreadsheet appears:



The screenshot displays the FluorEssence software interface. The main window shows a data table with the following columns: SIGNAL001, 529181(γ), 551181(γ), 574181(γ), 596181(γ), 619181(γ), 642181(γ), 664181(γ), 687181(γ), 709181(γ), 732181(γ), 754181(γ), 777181(γ), 800181(γ), 822181(γ), and 845181(γ). The rows represent intensity measurements for various excitation wavelengths, with row 22 (432 nm) highlighted. The top toolbar contains a 2D Intensity Map button. A file explorer window at the bottom shows the file structure for 'beads 15um ex 360', including folders 'data' and 'DfRtEmd1', and files like '-SIGN...', 'DfRtEmd1', and 'DfRtEmd2'.

**3** Choose an excitation wavelength (row) to examine.

Here we have chosen 432 nm excitation.

**4** Click the 2D Intensity Map button **2D**.

# Launch DataStation button

The **Launch DataStation** button closes the FluorEssence™ software, and starts DataStation software.



**Note:** This button only operates with TCSPC accessories.

- 1 In the toolbar, click the Launch DataStation  button.

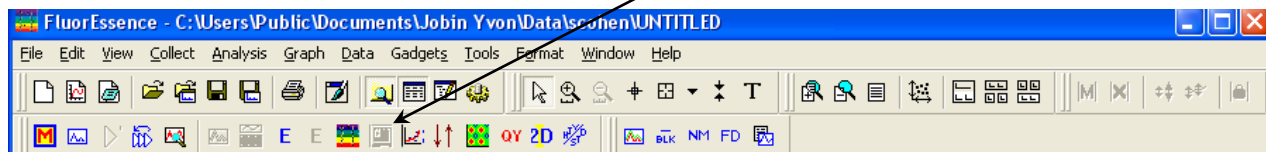

FluorEssence™ shuts down. DataStation starts.

# Switch menu between HJY Software Application and Origin Pro

The **Switch menu between HJY Software Application and Origin Pro** button switches the menus at the top of the main FluorEssence window between FluorEssence<sup>™</sup> and Origin<sup>®</sup> functions. This allows the user to tap the power more fully of Origin<sup>®</sup> software.

- 1 Click the Switch menu between HJY Software Application and Origin Pro button .

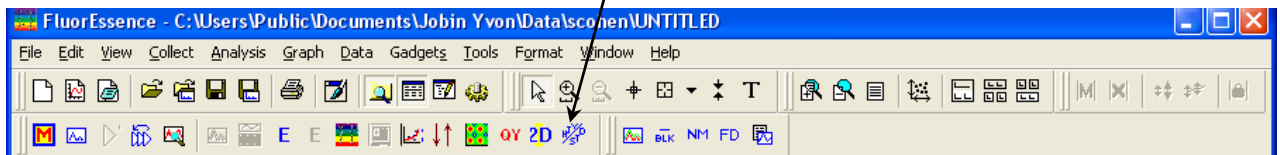

The menus at the top of the **FluorEssence** window change:

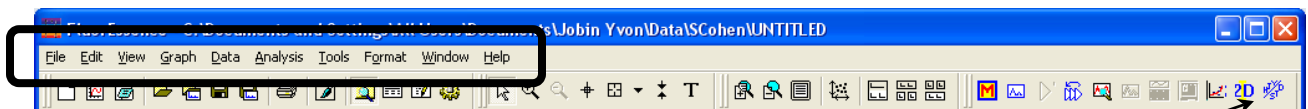

- 2 Click the Switch menu between HJY Software Application and Origin Pro button  again to return to the original menu functions.

# Multigroup

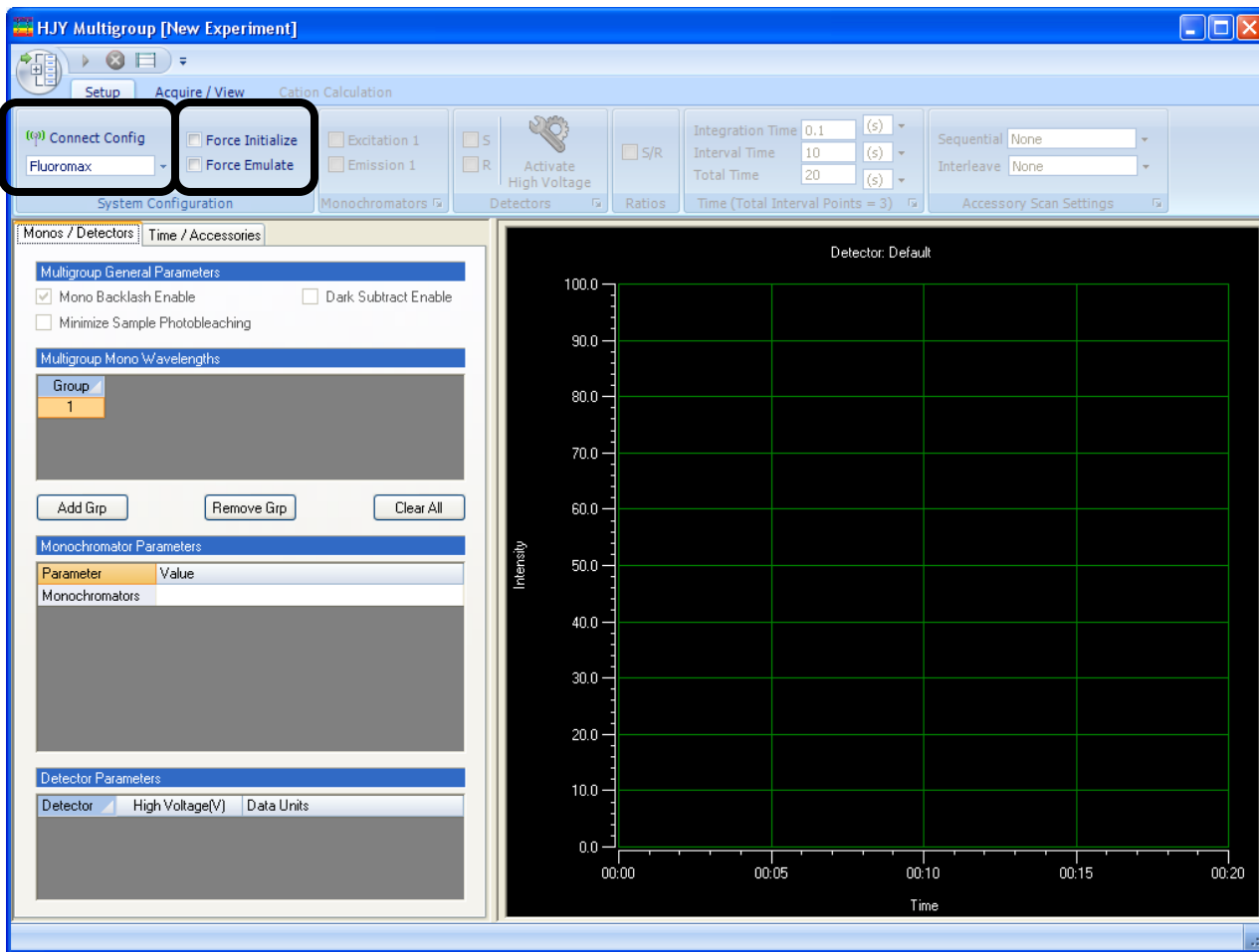

Multigroup offers repeated and sequential fluorescence experiments. Functions not included in FluorEssence™, such as delays, temperature ramps, and multiple samples and wavelength-groups are allowed within Multigroup.

## Basic steps to run Multigroup

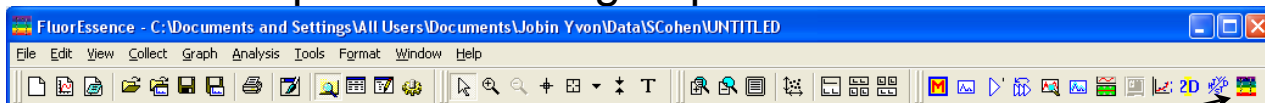

- 1 In the FluorEssence™ toolbar, click the Multigroup button ; or on the desktop, click the Multigroup icon.



If FluorEssence™ was active, it closes. The **Multigroup** window appears.

## 2 Connect to the desired instrument configuration.

a In the **System Configuration** area, select the configuration from the drop-down menu.

b Click the **Connect Config** button to initialize the instrument.

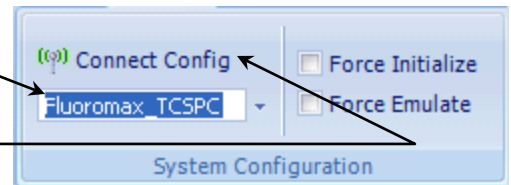

## 3 Activate the excitation and emission monochromators' checkboxes.

4 Activate the detector checkbox(es) and switch on high voltage if necessary, in the Detectors area.

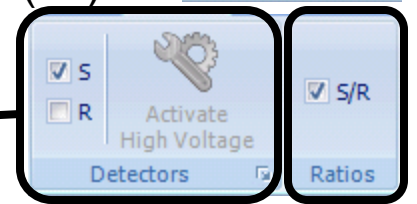
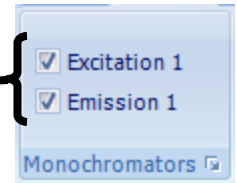

5 If desired, in the Ratios area, activate the ratio S/R checkbox to obtain corrected output.

6 In the Time area, choose various wavelength-groups and integration time.

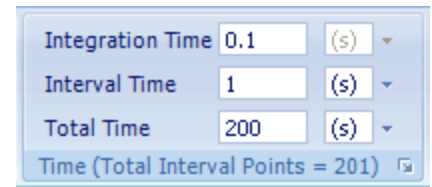

a For multiple integration times, use the **Time / Accessories** tab to add multiple time intervals.

b Choose the wavelength pair or multiple wavelength sets in the **Monos / Detectors** tab.

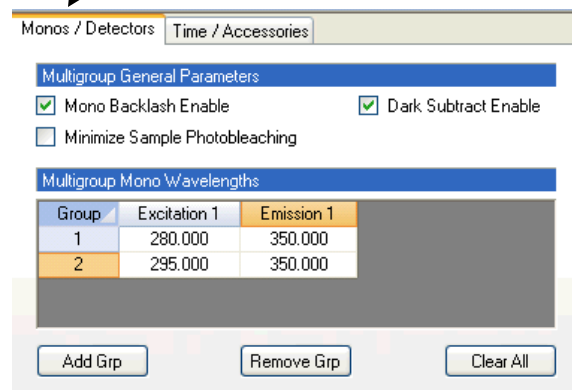
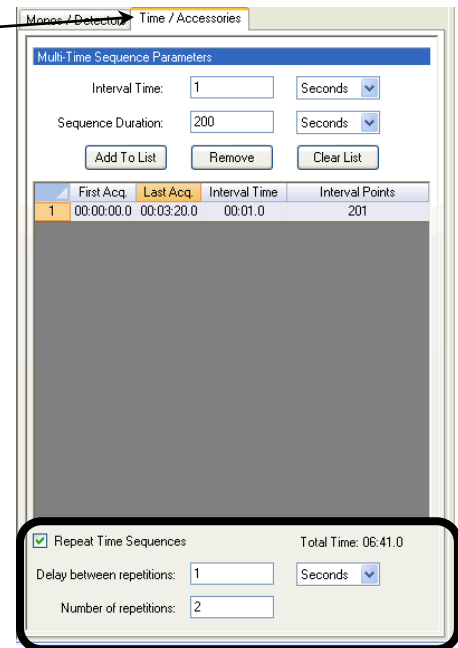

## 7 Select the accessories, looping, and delays.

- 8 Choose the slit-width parameters.

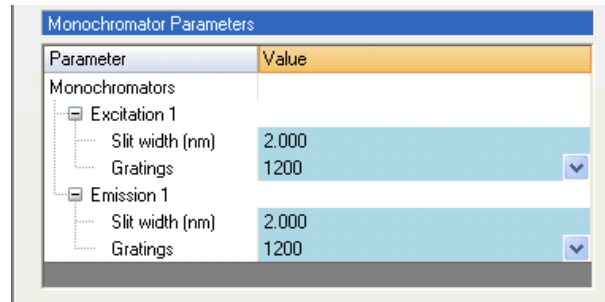

- 9 Choose the detector parameters.

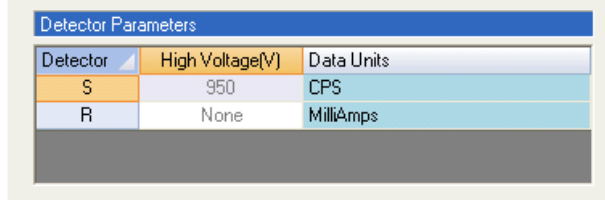

- 10 In the Acquire / View tab, click the Start button



to run the experiment.

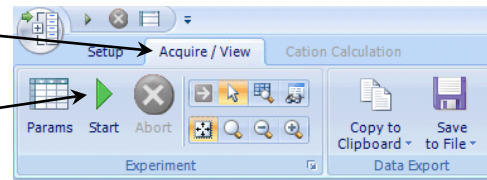

- 11 Run a “pre-scan” to make sure that the timing of the experiment can be achieved within the hardware limits.

Click the **Pre-scan** button, and remove any samples from the sample chamber.

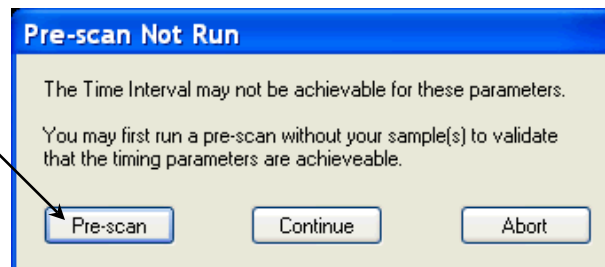

- 12 Save the data when the scan is finished.

In the **Data Export** area, choose either the **Copy to Clipboard** button or the **Save to File** button. More details on Multigroup are provided in the *FluorEssence™ User's Guide*.

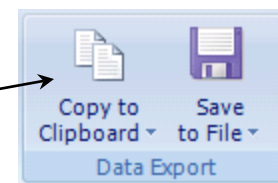

# Running an unknown sample

Often a researcher will scan a sample whose spectral characteristics are unknown. For optimal spectra, the optimal excitation and emission wavelengths must be found.

The traditional method consists of running an emission scan to find the peak emission value. Then an excitation scan is run using the determined peak emission value.

## 1 Find the preliminary emission maximum.

The object of this step is to acquire a preliminary emission scan, based on a “best-guess” excitation wavelength. Because the fluorescence emission of samples does not shift with excitation wavelength, the guessed excitation wavelength yields the emission peak, albeit perhaps at lower intensity.

a Be sure all system components are on, and the FluoroMax<sup>®</sup> Plus is calibrated as explained in Chapter 3.

b Click the **Experiment Menu** button :

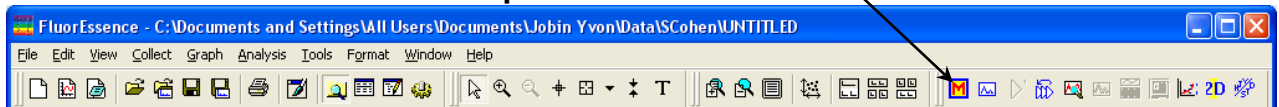

The **Fluorescence Main**

**Experiment Menu** appears:

c Choose the **Spectra** button.

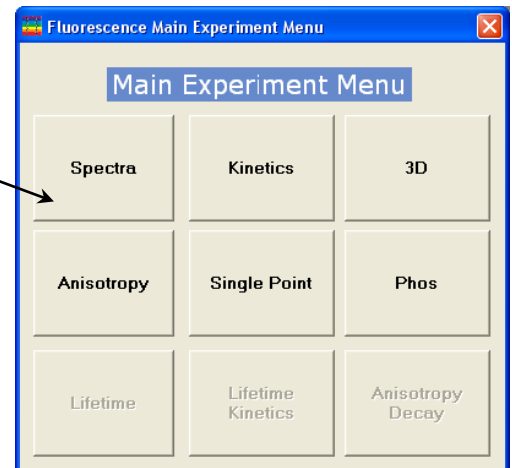

The **Experiment Type**

window appears:

d Choose **Emission**.

e Click the **Next >>** button:

The **Experiment Setup** window appears:

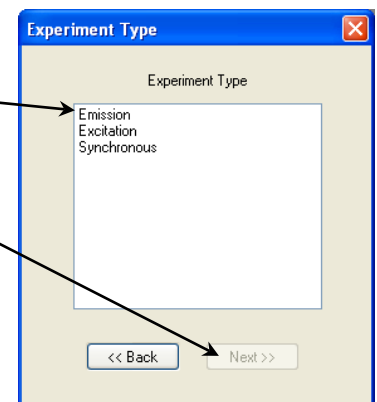

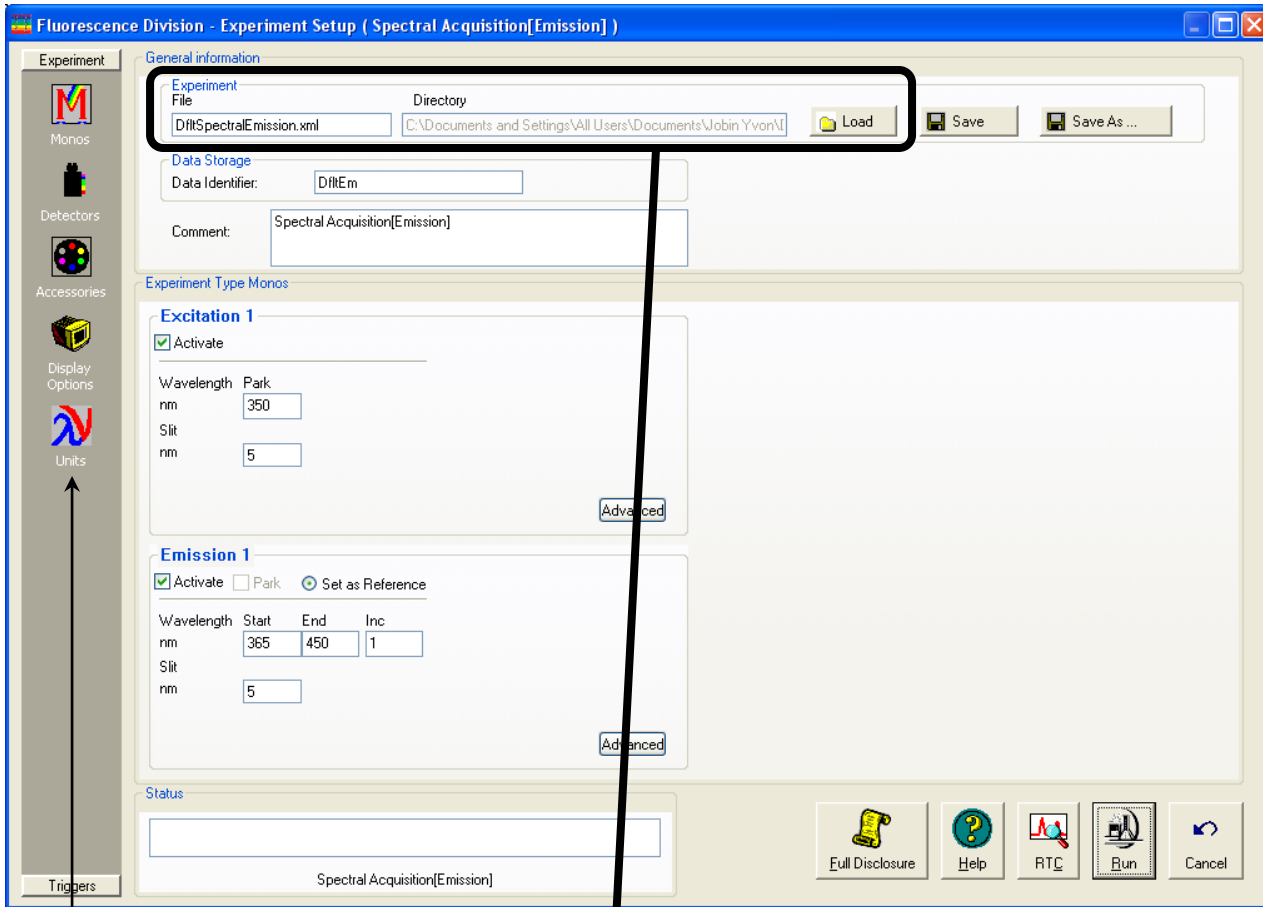

f Click the **Experiment File** field, and enter a new file name or select a previously saved file.

g Verify that experimental parameters are correct.  
Be sure to check all parameters under all icons in the left-hand column.

h Set the scan parameters.  
Most of these parameters are a trade-off between speed and precision. Choose integration time, increments, and number of scans judiciously, to give an accurate result without excessive time spent. HORIBA Scientific suggests an increment of 1.0 nm, an integration time of 0.1–0.5 s, and one scan. If unsure of an excitation wavelength, try 300 nm, at which many samples absorb light. Use S (signal detector) for the acquisition mode. Don't forget a data file name.



**Note:** To minimize Rayleigh scatter, offset the start position by at least 15 nm from the excitation wavelength, with a bandpass of 5 nm. For example, for an excitation wavelength of 300 nm, use 315 nm as the start. Set the ending wavelength to 550 nm. Use an increment of 2 nm and an integration time of 0.1 s.



- i Insert the sample into the sample compartment, and close the sample compartment's cover.
- j Click the **Run** button . The scan starts.
- k With the spectrum on the screen, note the greatest intensity. If the signal exceeds  $2 \times 10^6$  counts  $s^{-1}$ , then the emission detector is saturating, so close the slits more. If there is no obvious peak, increase the excitation wavelength, starting, and ending by 25 nm, and retry a scan.
- l With an acceptable emission peak, record its wavelength. This is the emission maximum. Otherwise, repeat steps i through l until an obvious emission peak appears.

## 2 Find the optimal excitation wavelength.

This procedure uses the emission maximum to determine the optimum excitation wavelength, and is similar to step 1.

- a In the toolbar, click the **Experiment Menu** button :

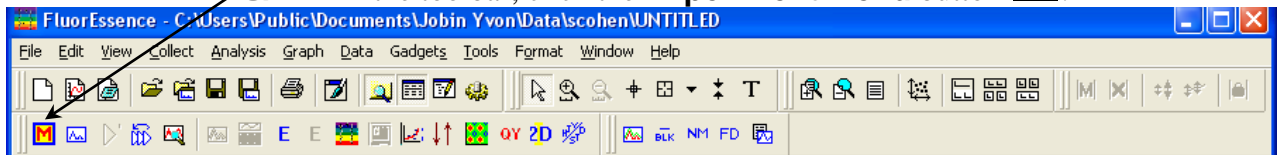

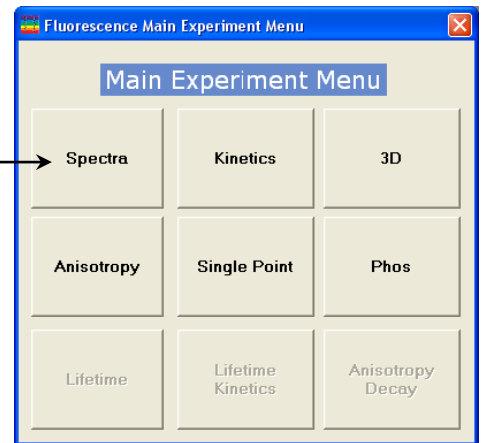

The **Fluorescence Main Experiment Menu** appears:

- b Choose the **Spectra** button. 





The **Experiment Type** window appears.

- c Choose **Excitation**. 
- d Click the **Next >>** button. 

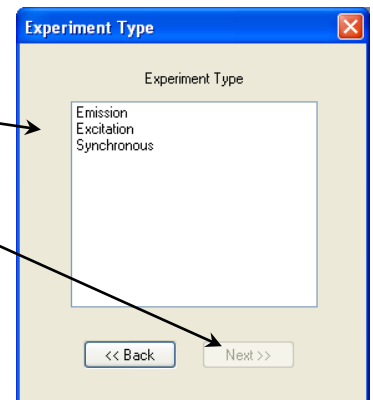
The **Experiment Setup** window appears:

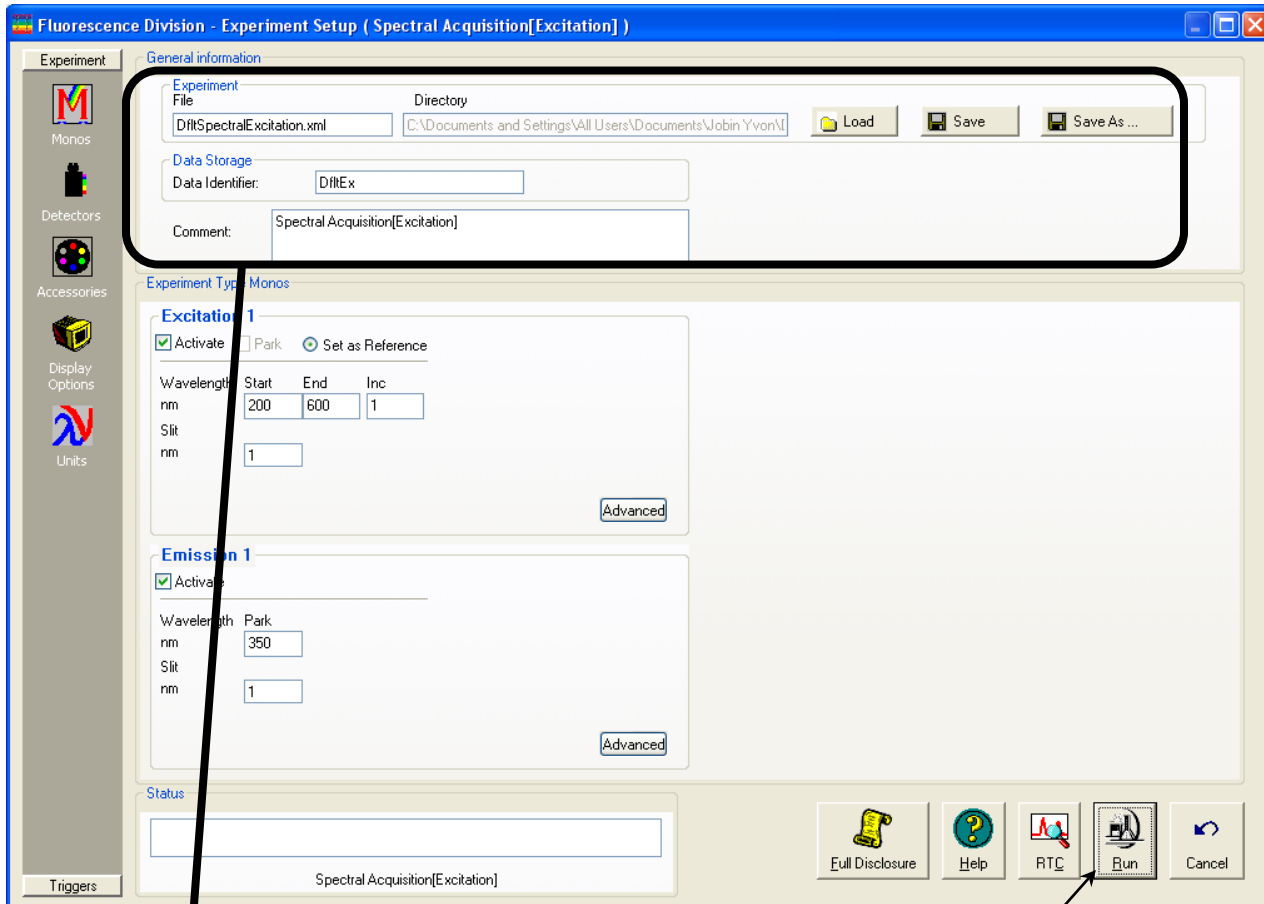



- e Set the scan parameters.  
Use the emission maximum determined above for the excitation, use 250 nm for starting, enter the emission maximum minus 15 nm for the end of the scan, and select two acquisition modes, **S** and **S/R**. **S** collects raw signal from the emission detector, and S/R ratios the signal to the reference detector.
- f Set excitation and emission slits identical to the emission scan.  
Be sure that the emission scan did not exceed  $2 \times 10^6$  counts  $s^{-1}$  in the S signal detector.
- g Enter the **Experiment File** name.
- h Click the **Run** button .  
The scan starts.  
The resulting spectrum shows maximum excitation wavelength. If the raw S-channel signal  $> 2 \times 10^6$  counts  $s^{-1}$ , reduce slits, and rescan.
- i Note the excitation peak.  
This is the optimum excitation peak position.

### 3 Find the optimal emission peak.

- a Use the optimum excitation wavelength determined in step 2.
- b When complete, both excitation and emission peaks are found. Optimized excitation and emission spectra of a  $1 \times 10^{-8}$ -*M* anthracene solution are shown below. Because the acquisition modes were different for the excitation and emission scans, the data intensity had to be normalized. After normalization, the excitation and emission scans are virtually mirror images of one another.

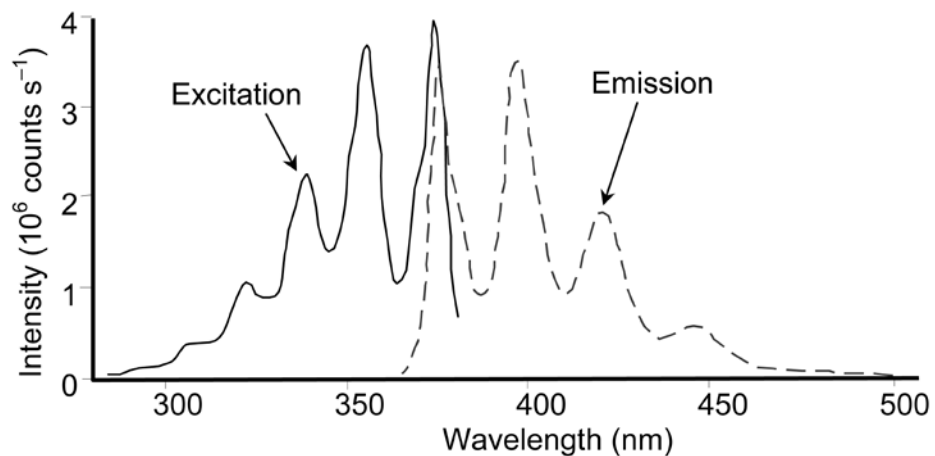

**Normalized excitation and emission spectra of a  $1 \times 10^{-8}$ -*M* anthracene solution.**

# Using corrected signals in FluorEssence™

## Introduction

Subtracting blanks, removing dark noise, and correcting for inhomogeneities in the instrument or detector response give more accurate spectra. Take special precautions to incorporate these functions properly into a FluorEssence™ experiment.

## Method

Any corrected signal (with a lower-case “c”) or algebraic use of corrected signals must explicitly include all desired corrected signals in the Formulas list. Corrected signals include:

- Dark Offset
- Blank Subtraction
- Correction-factor file



**Note:** To use a correction-factor file, you must also activate Dark Offset to eliminate generation of a baseline artifact. This artifact is caused by inappropriate multiplication of dark counts not related to the spectral response.

An example is provided on the next page.

# Example

Note how the corrected signal, **S1c**, and corrected reference, **R1c**, along with their ratio, **S1c/R1c**, all must be included in the **Formulas** list in the **Signal Algebra** area.



**Note:** Be sure all desired corrections are activated in their respective checkboxes.

The screenshot shows the 'Experiment Setup' window for a '3D Acquisition' experiment. The 'Signals' section contains a table with the following data:

Enable	Signal	Detector	Units	HV(V)	Correction	Blank Subtract
<input checked="" type="checkbox"/>	S1	Symphony	CPS	1173	<input checked="" type="checkbox"/>	<input type="checkbox"/>
<input checked="" type="checkbox"/>	R1	R	MicroAmp	1173	<input checked="" type="checkbox"/>	<input type="checkbox"/>
<input type="checkbox"/>	T1	T	CPS	950	<input type="checkbox"/>	<input type="checkbox"/>

The 'Signal Algebra' section shows a 'Formulas' list with the following entries:

Signal	Units
S1c	
R1c	
S1c / R1c	

The 'Dark Offset' checkbox in the Signals table and the 'S1c', 'R1c', and 'S1c / R1c' entries in the Formulas list are highlighted with black boxes. A yellow banner at the bottom of the window reads '3D Acquisition[Excitation vs Emission vs Intensity]'.



# 5 : Optimizing Data

Spectra can be enhanced by optimization of data-acquisition. This chapter lists some methods of optimizing sample preparation, spectrofluorometer setup, and data correction to get higher-quality data.

## Cuvette preparation

- 1 Empty all contents from the cuvettes.
- 2 Fully immerse and soak the cuvettes for 24 h in 50% aqueous nitric acid.

This cleans the cuvettes' inner and outer surfaces.

- 3 Rinse with de-ionized water.



- 4 Clean the cuvettes in the cleaning solution with a clean cotton swab if needed.

Use Alconox<sup>®</sup> or equivalent detergent as a cleaning solution.

- 5 Rinse the cuvettes with de-ionized water.
- 6 Soak the cuvettes in concentrated nitric acid.
- 7 Rinse them with de-ionized water before use.



**Note:** Clean the sample cells thoroughly before use to minimize background contributions.



**Warning:** Nitric acid is a dangerous substance. When using nitric acid, wear safety goggles, face shield, and acid-resistant gloves. Certain compounds, such as glycerol, can form explosive materials when mixed with nitric acid. Refer to the Materials Safety Data Sheet (MSDS) for detailed information on nitric acid.



**Caution:** Soaking the cuvettes for a long period in alkaline detergents such as Alconox<sup>®</sup> causes etching of the cuvette surface, which results in light-scattering from the cuvettes.

# Sample preparation



**Caution:** Always read the Materials Safety Data Sheet before using a sample or reagent.

The typical fluorescence or phosphorescence sample is a solution analyzed in a standard cuvette. The cuvette itself may contain materials that fluoresce. To prevent interference, HORIBA Scientific recommends using non-fluorescing fused-silica cuvettes that have been cleaned as described above.

## Small-volume samples

If only a small sample-volume is available, and the intensity of the fluorescence signal is sufficient, dilute the sample and analyze it in a 4-mL cuvette. If fluorescence is weak or if trace elements are to be determined, HORIBA Scientific recommends a capillary cell such as our 250- $\mu$ L optional micro-sample capillary cell, which is specifically designed for a small volume. A 1-mL cell (5 mm  $\times$  5 mm cross-section) is also available.

## Solid samples

Solid samples usually are mounted in the J1933 Solid Sample Holder, with the fluorescence collected from the front surface of the sample. The mounting method depends on the form of the sample. See the section on “Highly opaque samples” for more information on sample arrangement in the sample compartment.

- Thin films and cell monolayers on coverslips can be placed in the holder directly.
- Minerals, crystals, vitamins, paint chips, phosphors, and similar samples usually are ground into a homogeneous powder. The powder is packed into the depression of the Solid Sample Holder (see next page for diagram). For very fine powder, or powder that resists packing (and therefore falls out when the holder is put into its vertical position), the powder can be held in place with a thin quartz coverslip, or blended with potassium bromide for better cohesion.
- A single small crystal or odd-shaped solid sample (e.g., contact lens, paper) can be mounted with tape along its edges to the Solid Sample Holder. Be sure that the excitation beam directly hits the sample. To keep the excitation beam focused on the sample, it may be necessary to remove or change the thickness of the metal spacers separating the clip from the block.



**Note:** Avoid thick coverslips, because the excitation beam may not hit the sample directly with a thick coverslip. Microscope coverslips are useful, except that they are not quartz, and do not transmit UV light.



## Dissolved solids

Solid samples, such as crystals, sometimes are dissolved in a solvent and analyzed in solution. Solvents, however, may contain organic impurities that fluoresce and mask the signal of interest. Therefore, use high-quality, HPLC-grade solvents. If background fluorescence persists, recrystallize the sample to eliminate organic impurities, and then dissolve it in an appropriate solvent for analysis.

## Biological samples

For reproducible results, some samples may require additional treatment. For example, proteins, cell membranes, and cells in solution need constant stirring to prevent settling. Other samples are temperature-sensitive and must be heated or cooled to ensure reproducibility in emission signals.

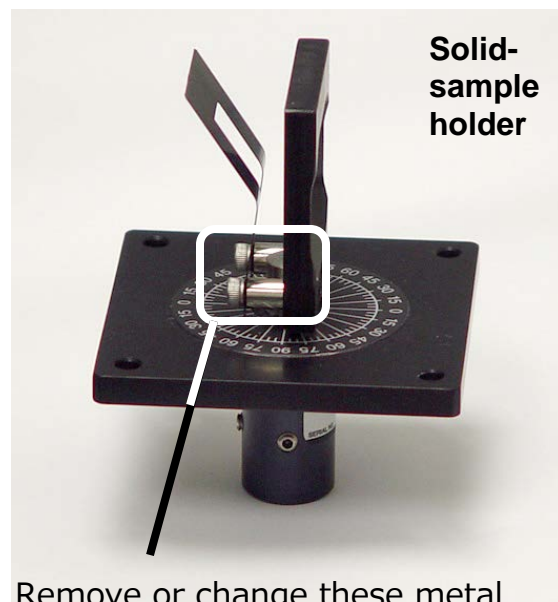

Remove or change these metal

# Running a scan on a sample

## Precautions with the Solid-Sample Holder

Avoid placing the front face of the sample so that the excitation beam is reflected directly into the emission monochromator. If the sample is rotated at  $45^\circ$  from excitation, this may occur, increasing interference from stray light. Instead, set up the sample with a  $30^\circ$  or  $60^\circ$ -angle to the excitation, preventing the excitation beam from entering the emission slits. The photograph at right illustrates how a  $60^\circ$ -angle to the excitation keeps the incoming excitation light away from the emission monochromator's entrance.

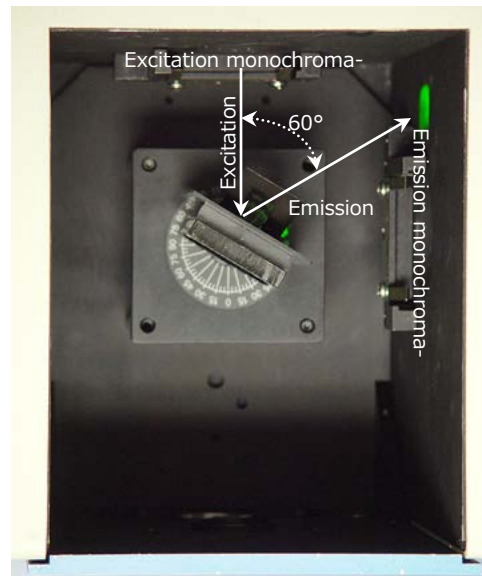

**Note:** The focal point of the excitation beam must be on the sample itself.

## Use filters in the optical path.

Stray light from the excitation beam can interfere with the emission from the sample. To reduce the deleterious effects of stray light, place a filter that removes excitation wavelengths from the emission beam in the emission optical path. Here is an example of scans with and without filters on a FluoroMax® Plus, using an unknown white powder as the sample. A 347 nm band-pass filter allows only the desired excitation to reach the sample, while a long-pass filter in the emission side lets only fluorescence, and no stray excitation into the detector. Notice how the shape of the spectrum changes drastically when filters are added.

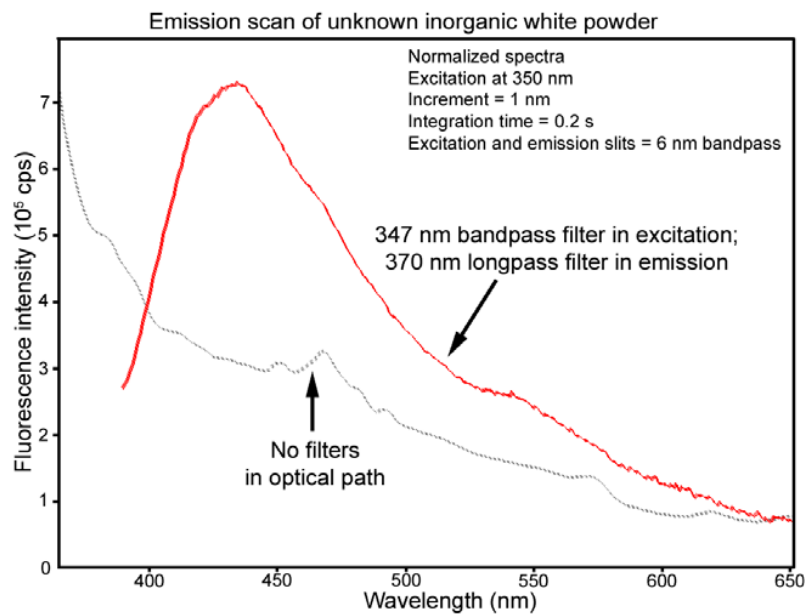

# Measuring the $G$ factor

Include the grating factor, or  $G$  factor, whenever polarization measurements are taken. The  $G$  factor corrects for variations in polarization wavelength-response for the emission optics and detectors. A pre-calculated  $G$  factor may be used when all other experimental parameters are constant. In other cases, the system can measure the  $G$  factor automatically before an experimental run.  $G$  factors are incorporated into the Anisotropy scan-type:

- 1 In the FluorEssence toolbar, click the Experiment Menu button .

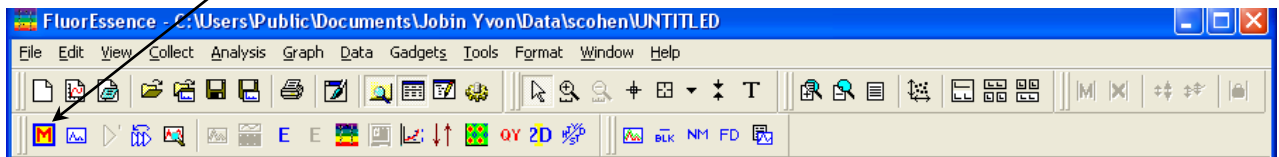

The **Fluorescence Main Experiment Menu** appears.

- 2 Click the Anisotropy button.

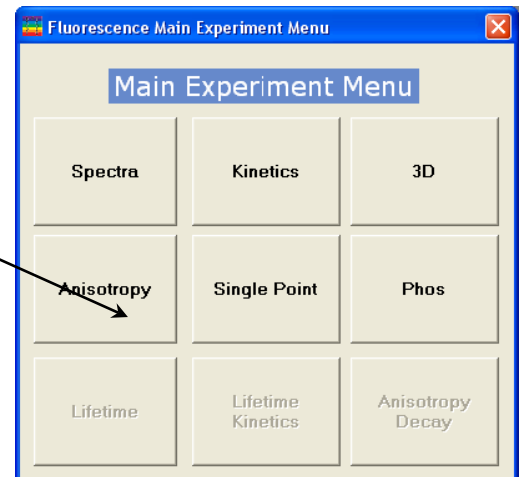

The Experiment Type window appears.

- 3 Choose the type of Anisotropy experiment, then click the Next >> button.

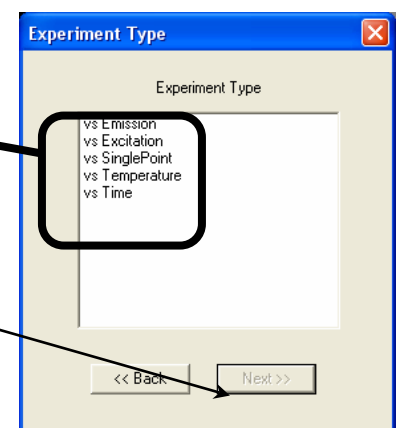

The **Experiment Setup** window opens. To determine polarization at particular excitation/emission wavelength-pairs, choose **vs SinglePoint**.

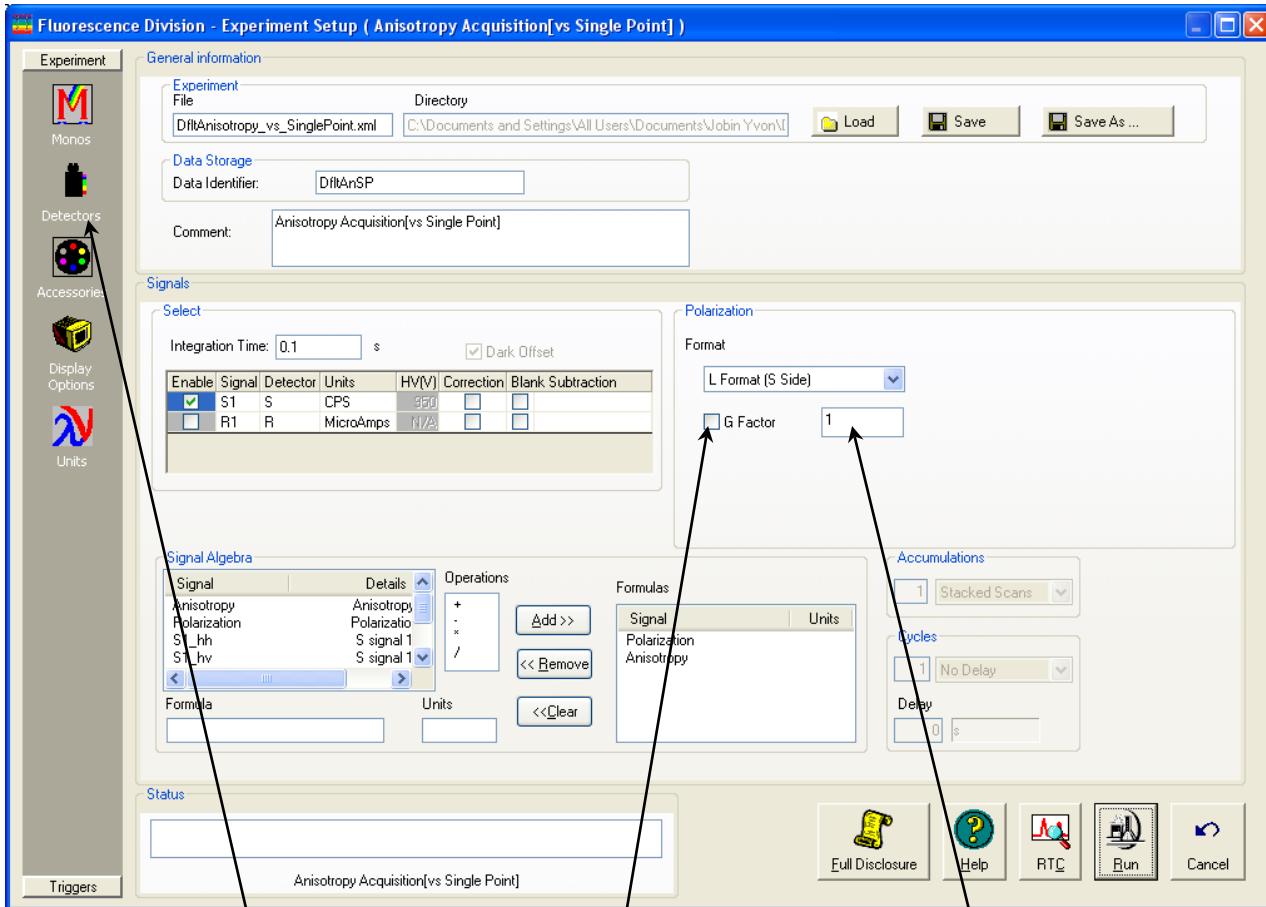

#### 4 Click the Detectors icon.

This shows the parameters related to detectors, including the *G* factor, in the **Polarization** area.

#### 5 Click the *G* Factor checkbox to include a *G* factor in your measurements.

Activate the checkbox **ONLY** if you know the *G* factor. De-activate the checkbox if you want to measure the *G* factor.

#### 6 Enter a value for the *G* factor in the field if you know and want to use a pre-determined value.



**Note:** For weak signals, enter the *G* factor, rather than measure it automatically. This may improve the SN.



**Note:** For detailed information on the *G* factor, see the **Polarizers Operation Manual**.

# Improving the signal-to-noise ratio

Because of various hardware or software conditions, occasionally it is necessary to optimize the results of an experiment.

The quality of acquired data is determined largely by the signal-to-noise ratio ( $S/N$ ). This is true especially for weakly fluorescing samples with low quantum yields. The signal-to-noise ratio can be improved by:

- Using the appropriate integration time,
- Scanning a region several times and averaging the results,
- Changing the bandpass by adjusting the slit widths, and
- Mathematically smoothing the data.

The sections that follow discuss the alternatives for improving the  $S/N$  ratio and the advantages and disadvantages of each.

## Determining the optimum integration time

The length of time during which photons are counted and averaged for each data point is referred to as the *integration time*. An unwanted portion of this signal comes from noise and dark counts (distortion inherent in the signal detector and its electronics when high voltage is applied). By increasing the integration time, the signal is averaged longer, resulting in a better *S/N*. This ratio is enhanced by a factor of  $t^{1/2}$ , where  $t$  is the multiplicative increase in integration time. For example, doubling the integration time from 1 s to 2 s increases the *S/N* by over 40%, as shown below:

For an integration time of 1 second,

$$\begin{aligned} S / N &= t^{1/2} \\ &= 1^{1/2} \\ &= 1 \end{aligned}$$

For an integration time of 2 seconds,

$$\begin{aligned} S / N &= t^{1/2} \\ &= 2^{1/2} \\ &\approx 1.414 \end{aligned}$$

or approximately 42%.

Because *S/N* determines the noise level in a spectrum, use of the appropriate integration time is important for high-quality results.

### To discover the appropriate integration time:

- 1 Find the maximum fluorescence intensity by acquiring a preliminary scan, using an integration time of 0.1 s and a bandpass of 5 nm.
- 2 From this preliminary scan, note the maximum intensity, and select the appropriate integration time from the table below.

Signal intensity (counts per second)	Estimated integration time (seconds)
1000 to 5000	2.0
5001 to 50 000	1.0
50 001 to 500 000	0.1
500 001 to 4 000 000	0.05



**Note:** This table is only a **guide**. The optimum integration time for other measurements, such as time-base, polarization, phosphorescence lifetimes, and anisotropy, may be different.

Set integration time through **Experiment Setup** for a specific experiment, or **Real Time Control** to view the effects of different integration times on a spectrum. See the FluorEssence™ on-line help to learn more about setting the integration time.

## Scanning a sample multiple times

Scanning a sample more than once, and averaging the scans together, enhances the *S/N*. In general, the *S/N* improves by  $n^{1/2}$ , where *n* is the number of scans.

**To scan a sample multiple times,**

- 1 Open the Experiment Setup window.
- 2 Choose the Detectors icon.
- 3 Specify the number of scans, and how to handle multiple scans, in the Accumulations field.

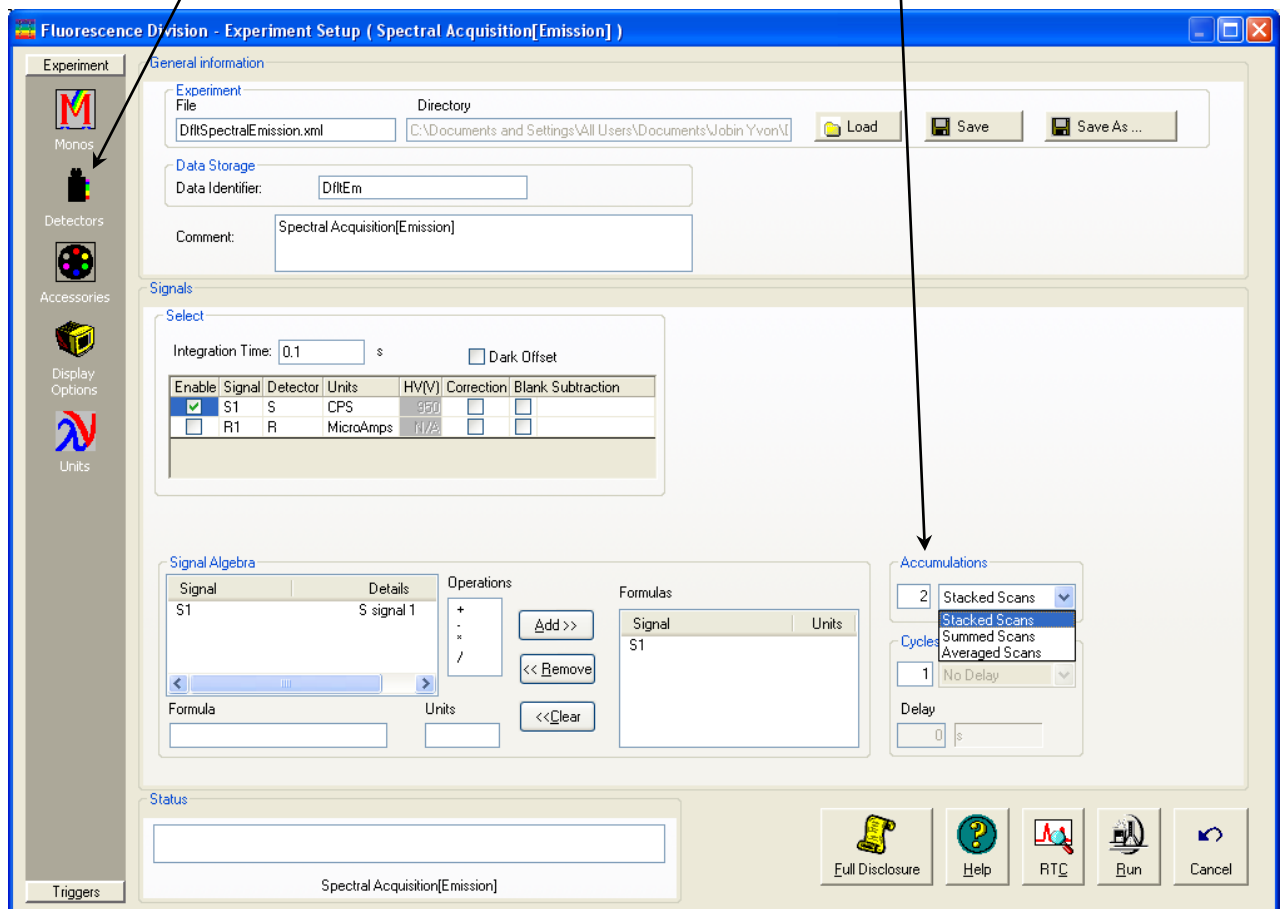

See FluorEssence™ on-line help for detailed instructions regarding the data-entry fields.

## Using the appropriate wavelength increment

The increment in a wavelength scan is the spacing, in nm, between adjacent data points. The spacing between the data points affects the resolution of the spectrum, and total time for acquisition. Consider the required resolution, time needed, and concerns about sample photobleaching. Most samples under fluorescence analysis display relatively broad-band emissions with a Lorentzian distribution, so they do not require a tiny increment.

Common increments range from 0.05–10 nm, depending on the sample and slit size. A first try might be 0.5–1 nm increment. After acquiring the initial spectrum, examine the results. If two adjacent peaks are not resolved (i.e., separated) satisfactorily, reduce the increment. If the spectrum is described by an excessive number of data points, increase the increment, to save time and lamp exposure. A scan taken, using an increment of 0.1 nm, with a peak at full-width at half-maximum (FWHM) of 20 nm, should be characterized with a 1-nm increment instead.

For time-based scans, the increment is the spacing in s or ms between data points. Here, the consideration is the necessary time-resolution. The time increment dictates the total time per data point and for the scan in general. Set this value to resolve any changes in the luminescence of samples as they react or degrade. Time increments often range from 0.1–20 s.

Set increments in the Inc field, under **Monos** in the **Experiment Setup** window.

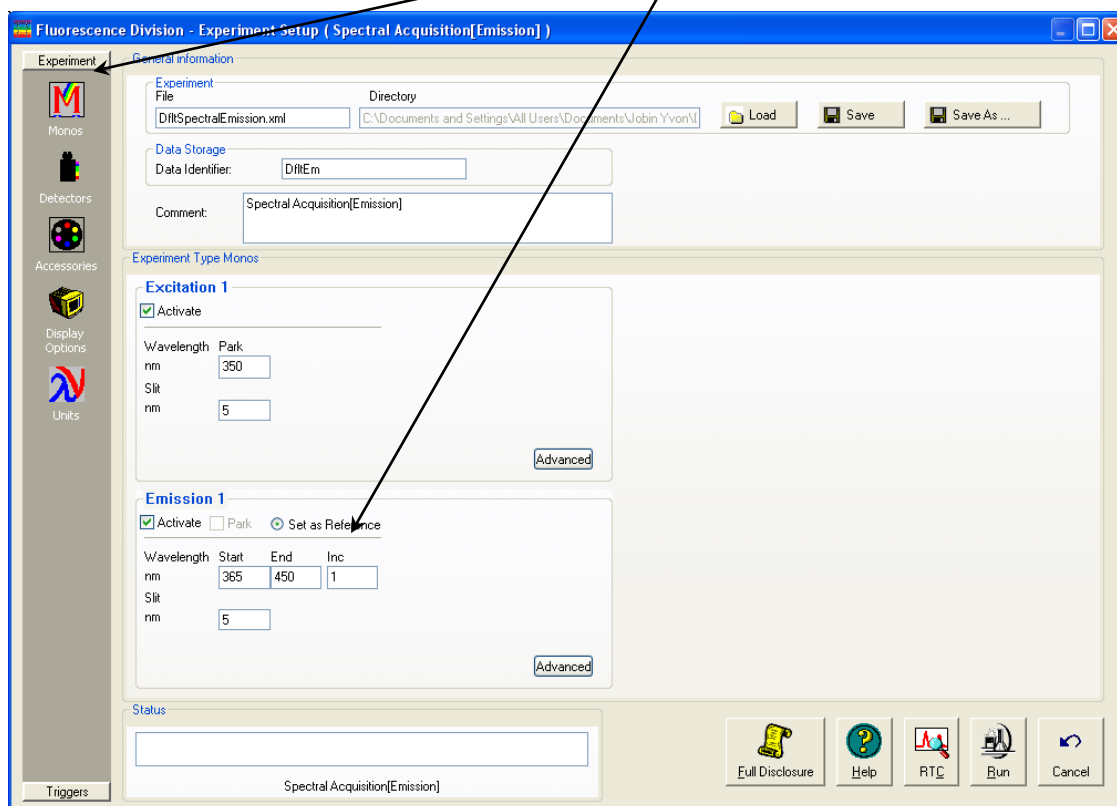

See the FluorEssence™ on-line help for more information.



## Selecting the appropriate bandpass

The bandpass (wavelength spread) affects the resolution of your spectra. If the bandpass is too broad, narrow peaks separated by a small change in wavelength may be unresolved. For example, for two 2-nm peaks 5 nm apart, and a bandpass of 10 nm, one broad peak, instead of two well-defined ones, is visible.

By adjusting the slit widths, the intensity and bandpass of the light is controlled. The slits of the excitation spectrometer determine the amount of light that passes through the excitation spectrometer to the sample. The emission spectrometer slits control the amount of fluorescence recorded by the signal detector. Signal level is proportional to the square of the slit width, that is,

$$\text{signal level} \propto (\text{slit width})^2$$

Bandpass is calculated using the following formula:

$$\text{bandpass (nm)} = \text{slit width (mm)} \times \text{dispersion (nm/mm)}$$

A FluoroMax<sup>®</sup> Plus, which has a single-grating monochromator and 1200 grooves/mm gratings, has a dispersion of 4.25 nm/mm.

For steady-state fluorescence measurements, set the entrance and exit slits the same for a monochromator. (This occurs automatically when using bandpass units in FluorEssence™.) For biological samples that may photobleach, try narrowing the excitation slits and opening the emission slits wider.

## Smoothing data

Smoothing the data improves the appearance of the spectrum. Smoothing, as are most post-processing features, is handled by Origin<sup>®</sup>.

- 1 Select Analysis from the main FluorEssence<sup>™</sup> toolbar.

A drop-down menu appears.

- 2 Choose Smooth....

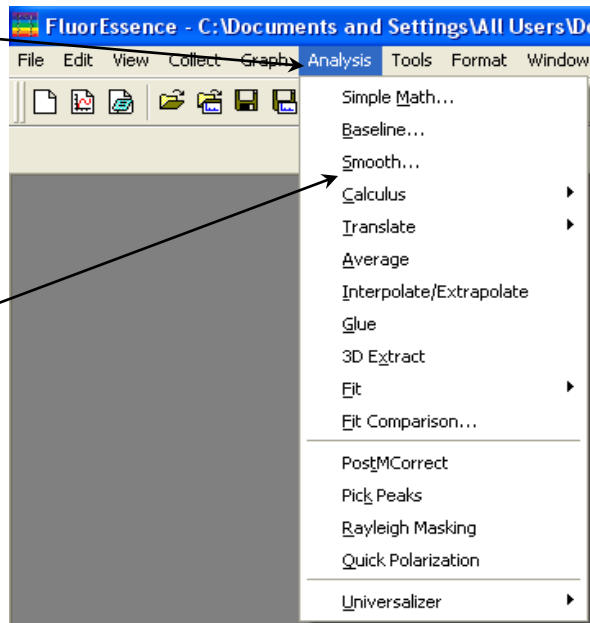

The **Smooth** window opens.

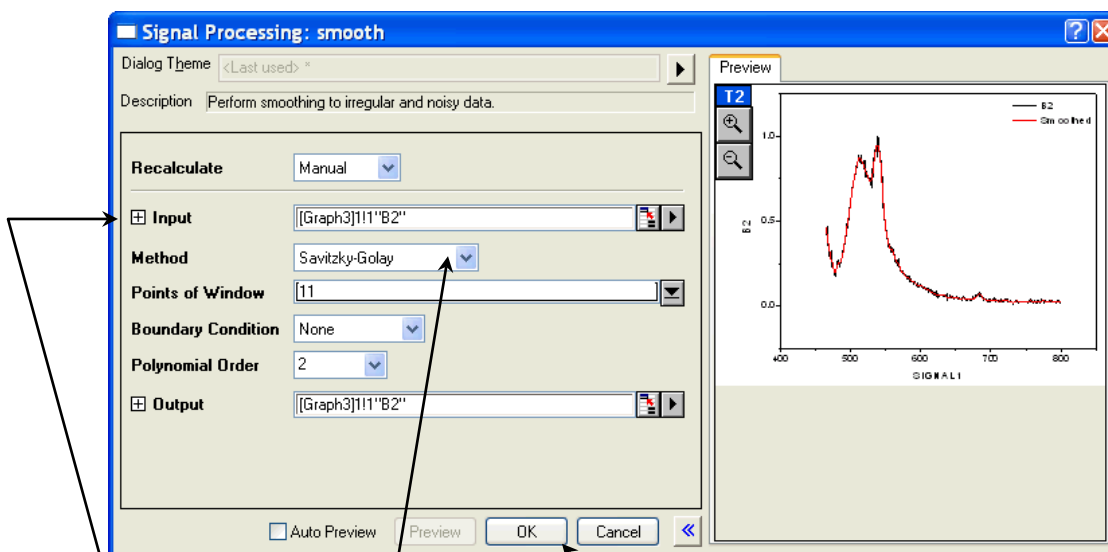

- 3 In the Input drop-down menu, choose the appropriate file to smooth.
- 4 In the Method drop-down menu, choose FFT Filtering (fast-Fourier transform), Adjacent Averaging, or Savitzky-Golay smoothing.
- 5 Click the OK button to smooth the data.

See the on-line Origin<sup>®</sup> help for additional information regarding smoothing data.

In general, start with a 9- or 11-point smooth for a time-base measurement. To select the proper number of points for wavelength-scan types, first locate the area that requires smoothing—usually this is a peak. Determine the number of data points used to make up the peak, and then smooth the data using the number of points closest to this number. To avoid artificially enhancing the data, use the appropriate number of points to smooth the data. For example, selection of too large a number results in the background being smoothed into the peak.

# Correcting data

## Introduction

Collecting accurate information about the fluorescent or phosphorescent properties of a sample depends upon several factors:

- Equipment specifications
- Sample characteristics
- Timing considerations.

To ensure that the spectra collected indicate the actual properties of the sample and not external conditions, data often must be corrected. To *correct* data means to remove information from the data not directly related to the properties of the sample. Gratings, detectors, and other spectrometer components have response characteristics that vary as a function of wavelength. These characteristics may be superimposed on spectra, thereby yielding a potentially misleading trace. For accurate intensity comparisons, such as those required for quantum-yield determinations, response characteristics must be eliminated. Supplied with the instrument are sets of excitation and emission correction factors to eliminate response characteristics. These files<sup>1</sup>, `xcorrect` and `mcorrect`, are included with the software.



**Note:** The excitation range is 240–600 nm; the emission range is 290–850 nm.

Items that may be convoluted into a spectrum	Ways to remove these artifacts
Fluctuations caused by the light source	Monitoring lamp output using the reference detector, R, and using the signal ratio S/R to correct lamp profile or temporal fluctuations
Influence of the sample holder	Running a blank scan (which is then subtracted from the sample scan)
System hardware (e.g., optics, detectors)	Using radiometric correction factors

To use radiometric correction factors, either:

- Select the ones supplied with the program, or
- Select a set generated at your facility during or after acquisition, discussed in the following section. Acquiring radiometric correction factors is explained in Chapter 8: *Producing Correction Factors*.

Blank Subtraction and Dark Offset functions are described in the on-line FluoroEssence™ help files.

<sup>1</sup> Filenames include a three-letter extension. For the sake of clarity, we have omitted the extensions in this section.

## During acquisition

Data can be acquired either as raw data or as corrected data. A spectrum composed of raw data exhibits the effects of system parameters, while a corrected spectrum displays only the properties related to the sample.



**Note:** Before applying correction factors, HORIBA Scientific recommends subtracting the dark counts, and the spectrum of the blank, from the data. See the on-line FluorEssence™ help files for specific instructions.



**Caution:** The *mcorrect* and *xcorrect* files are custom-generated at the factory for each particular instrument, and cannot be swapped.

- 1 Be sure the instrument configuration has a layout that includes a correction file associated with the appropriate detector.

- a Choose **Collect** in the toolbar. A drop-down menu appears.

- b Choose **Advanced Setup**, then **System Configuration**. The **System**

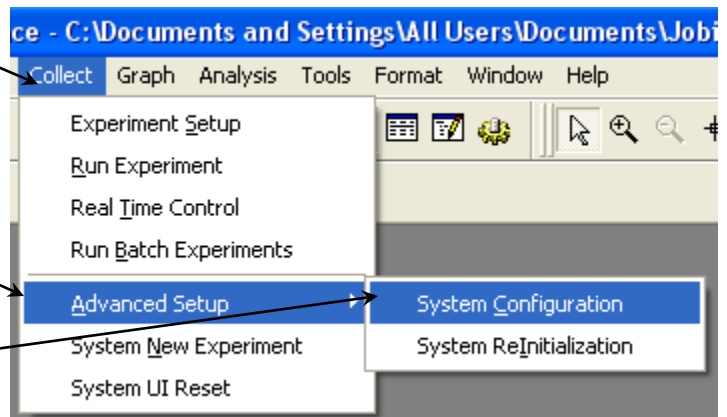

The **System Configuration** window appears:

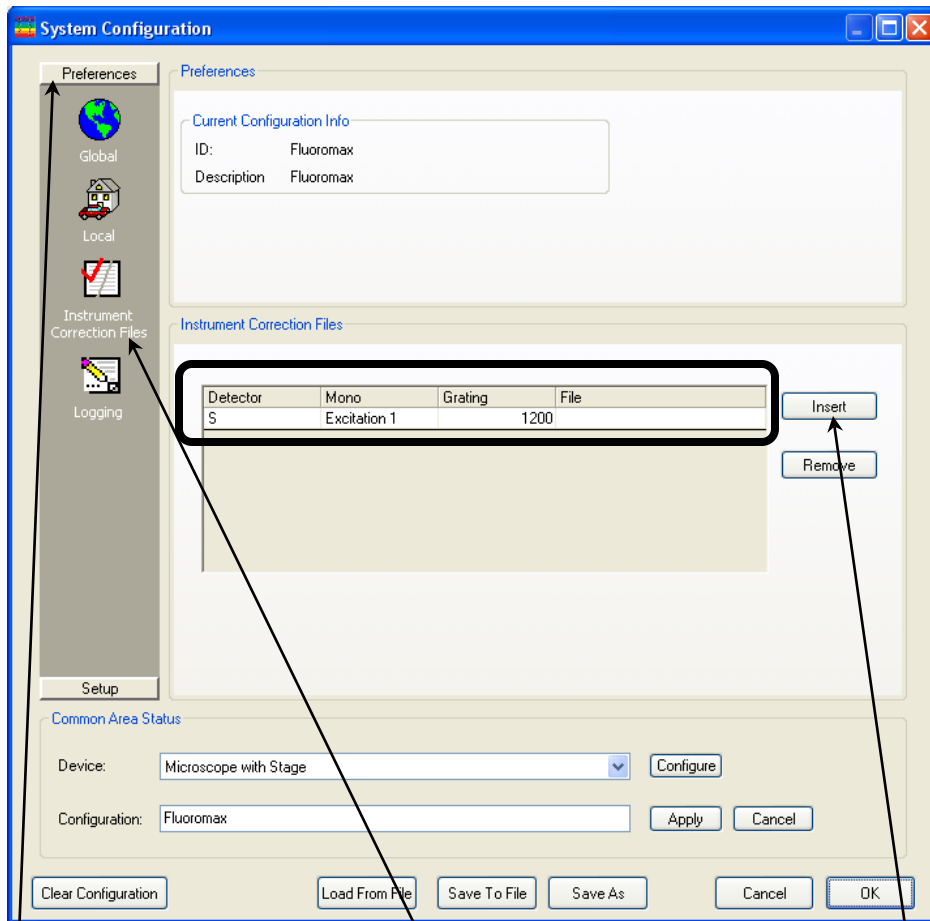

- C Choose **Preferences**, then the **Instrument Correction Files** icon. The **Instrument Correction Files** area should display a correction file for the Detector (S or R). If not, click the **Insert** button, and browse for the desired correction file.

**Detector Correction-factor file name**

S	mcorrect
R	xcorrect

2 Choose correction when setting up the experiment.

- a In the **Experiment Setup** window, choose the **Detectors** icon to display the detectors' parameters.
- b Click the **Correction** checkbox for the detector you want corrected. In the **Signal Algebra** area, a signal with appended "C" appears, denoting a corrected signal:

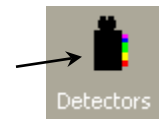

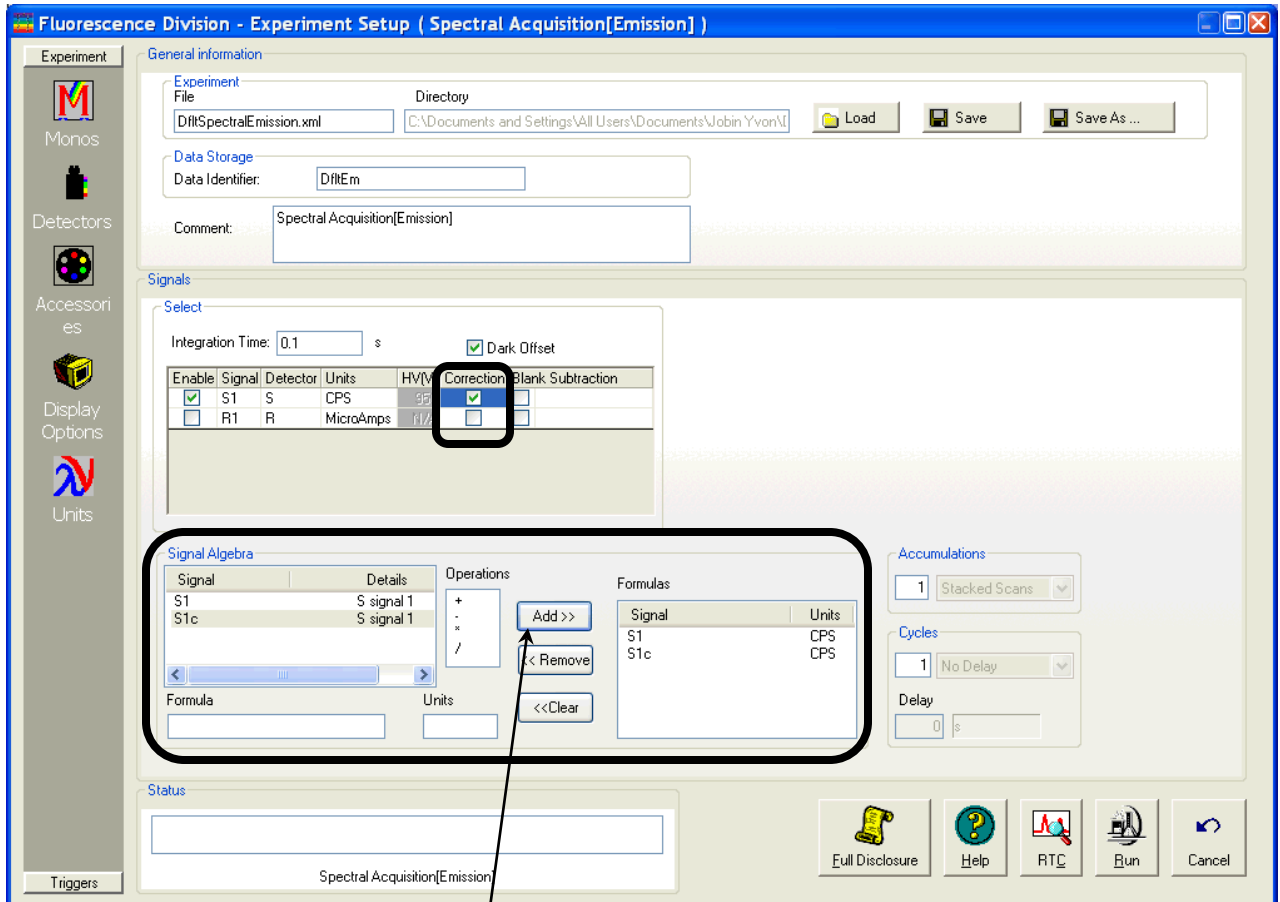

- c Click the **Add >>** button to add the corrected signal to the **Formulas** table.  
The corrected signal appears in the **Formulas** table.
- d Run the experiment with the corrected signal.

## After acquisition

To apply the correction factors after the data have been acquired, multiply the data file by the appropriate correction factor file (mcorrect for the S detector or xcorrect for the R detector).

- 1 Make sure the graph is open, and the trace to be corrected is active in the main FluorEssence window.
- 2 Choose Analysis.

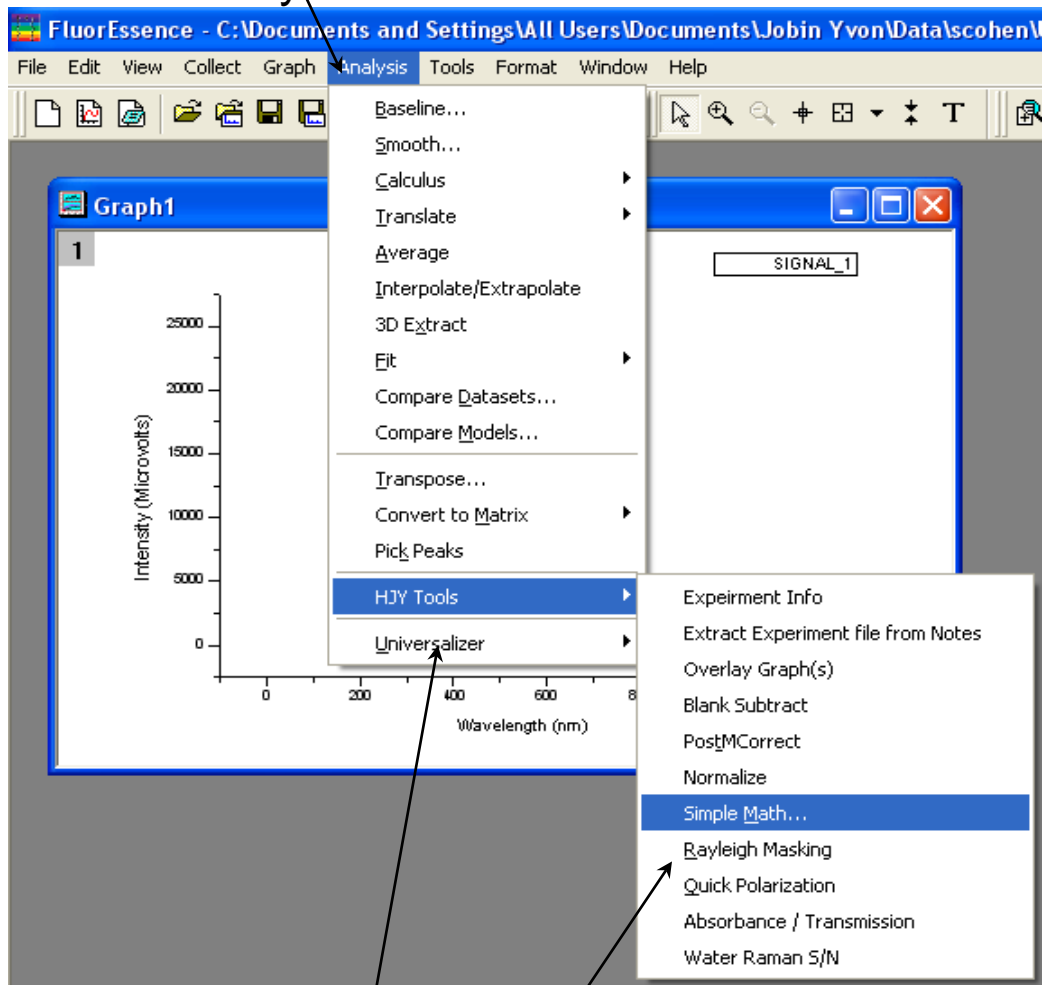

A drop-down menu appears.

- 3 Select HJY Tools.

Another drop-down menu appears.

- 4 Select Simple Math....

The HJY\_simple\_math window opens:



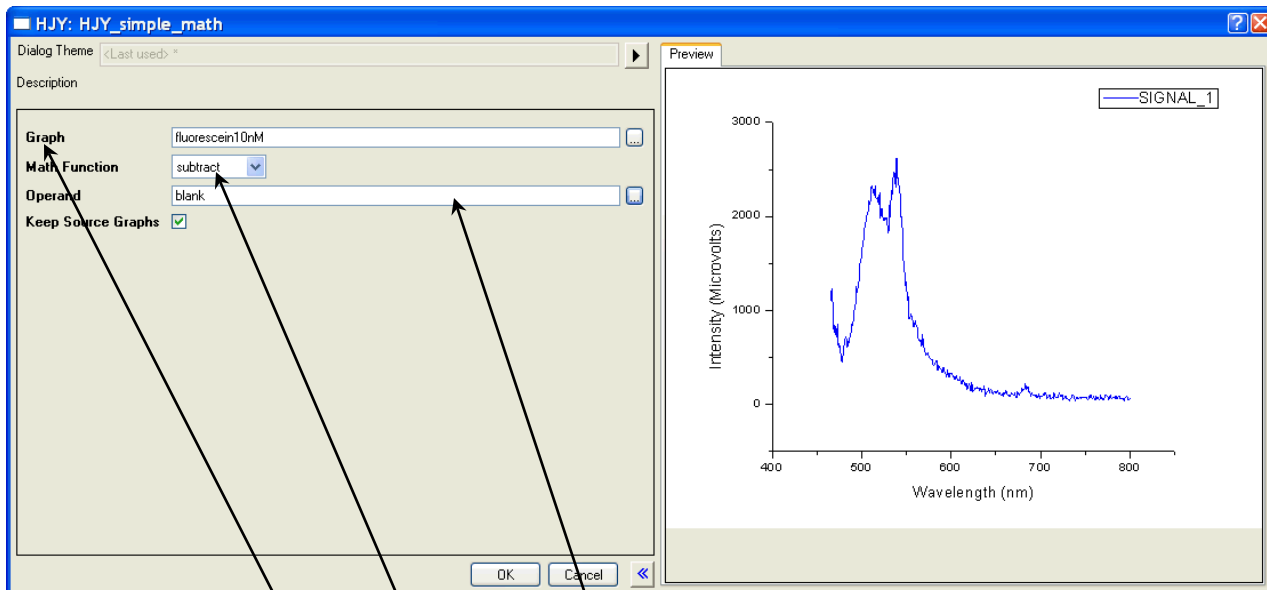

The name of the chosen trace should appear in the Graph field. If not, browse for it with the drop-down menu.

- 5 From Math Function, select multiply from the drop-down menu.
- 6 Browse for the appropriate correction-factor file in the Operand field (`mcorrect` or `xcorrect`).  
You may also enter a numerical constant if you choose.
- 7 If you want to create a new graph, activate the Keep Source Graphs checkbox.

If the **Keep Source Graphs** checkbox is inactive, the data in the current graph are overwritten.

- 8 Click the OK button.

The trace that appears on the screen is a result of the mathematical operation, giving a corrected spectrum.



# 6 : Maintenance

## Introduction

The FluoroMax<sup>®</sup> Plus requires little maintenance. To remove dust and fingerprints, wipe the outside panels with a clean, damp cloth. The lamp is the only component that must be replaced routinely. Regular examination of the xenon-lamp scan and water Raman spectrum serves as early indicators of the system's integrity. See Chapter 3 for these tests.

## Lamp replacement

### When to replace the lamp

Obtaining good spectral results depends on the xenon lamp. Keep track of lamp usage with the hour meter. After 1200–1500 h of use, the lamp output decreases significantly, indicating that the lamp should be replaced. A new lamp produces a peak intensity of 400 000 cps for a water-Raman scan; when the current lamp's output drops below 100 000 cps, replace it. Replacing the lamp within the recommended time may prevent a catastrophic failure. Each time the lamp is turned on constitutes one full hour of use. Therefore, HORIBA Scientific suggests leaving the lamp on during brief periods of inactivity.

### Parts and tools required

#### Xenon lamp

The replacement xenon lamp is packed in the manufacturer's box. Read all instructions and precautions before removing the lamp from the protective cover, and inserting it into the FluoroMax<sup>®</sup> Plus.



**Warning:** Do not remove the protective cover from the replacement lamp until instructed to do so.

#### Phillips screwdriver

3/32" Allen key

7/64" Allen key

1/8" Allen key

9/64" Allen key



**Warning:** Xenon lamps, by nature, are an explosion hazard. Be sure that the power is off, and all AC (mains) power is disconnected from the system. Read and follow all the cautions below:



## Hazards

- Xenon-arc lamps are an explosion hazard. Wear explosion-proof face-shield and protective clothing when opening the lamp housing and handling the lamp.
- Disconnect the lamp power supply from the AC power line (mains) while handling lamp leads. Lethal high voltages may exist.
- The lamp remains extremely hot for approximately one-half hour after it has been turned off. Do not touch the lamp or the metal unit until the lamp has cooled.
- Never look directly at the xenon arc or its reflection. Intense radiation can permanently damage eyes.
- Do not touch the focusing lens, back-scatter mirror, or the surface of the lamp. Fingerprints will be burned onto these surfaces when the lamp is ignited.



## Changing the lamp

- 1 Switch off and prepare the FluoroMax<sup>®</sup> Plus.
  - a Be sure that the FluoroMax<sup>®</sup> Plus and the host computer are turned off.
  - b Remove the AC (mains) power cord from the FluoroMax<sup>®</sup> Plus.
  - c Disconnect the USB cable, optional trigger-box cable, power cord, and any other cables attached to the spectrofluorometer.
- 2 Gently remove the sample mount from the front of the FluoroMax<sup>®</sup> Plus.

The standard FluoroMax<sup>®</sup> Plus front is held via a friction fit, with no screws to remove. Some accessories require removal of four screws. Some sample mounts also have a 15-pin connector at the inside end for automated accessories.

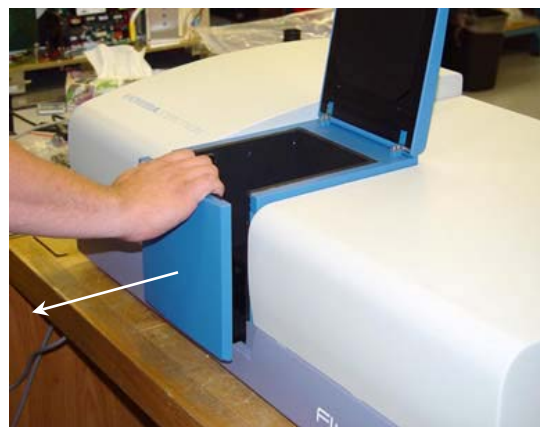

### 3 Remove the lamp cover.

- a With an Allen key, remove the five screws from inside the left wall of the sample compartment.

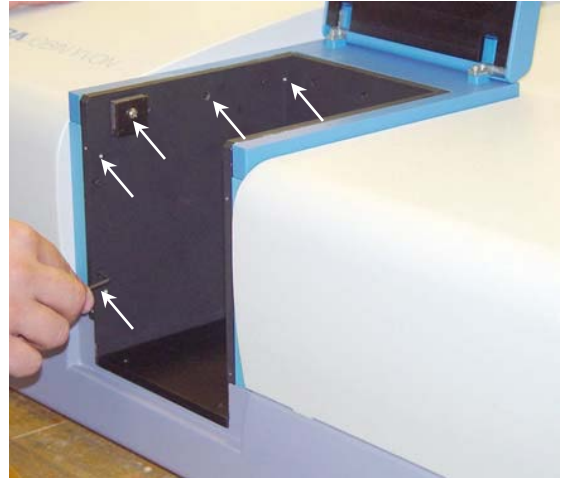

- b Pull the lamp cover to the left about 2 cm.

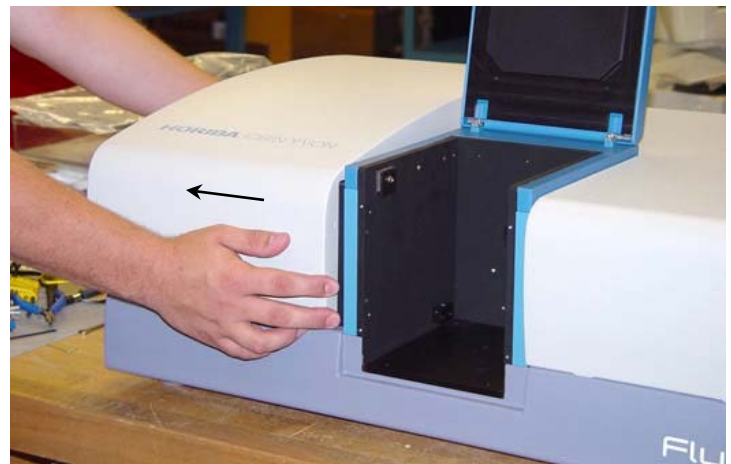

- c Lift the cover vertically off the instrument.

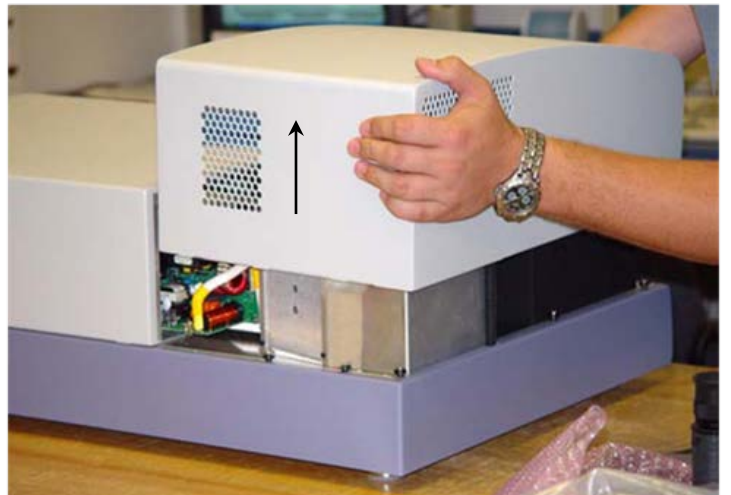

## 4 Remove the lamp-housing cover at the rear of the instrument.

- a With a Phillips screwdriver, loosen the safety cover's screw.

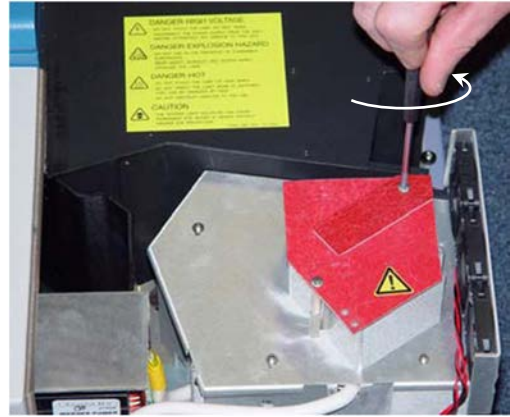

- b Swing the safety cover out of the way.

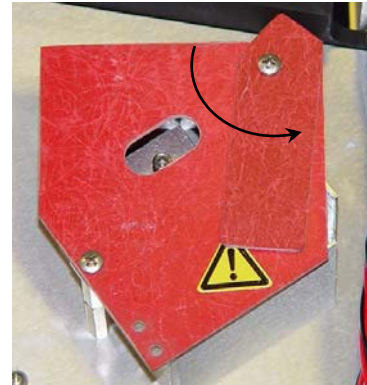

- c Remove the three cap screws from the lamp-housing cover.

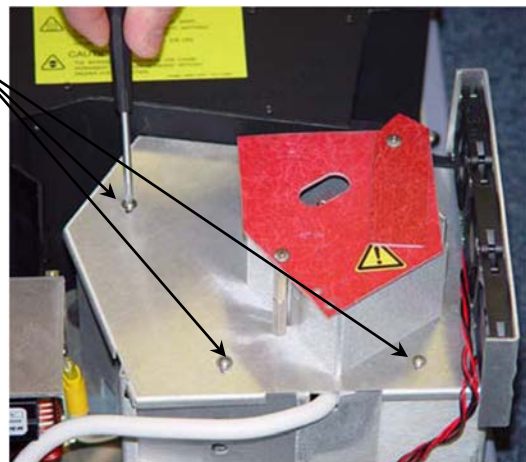

- d Gently rotate the lamp-housing cover with its cooling fans attached.

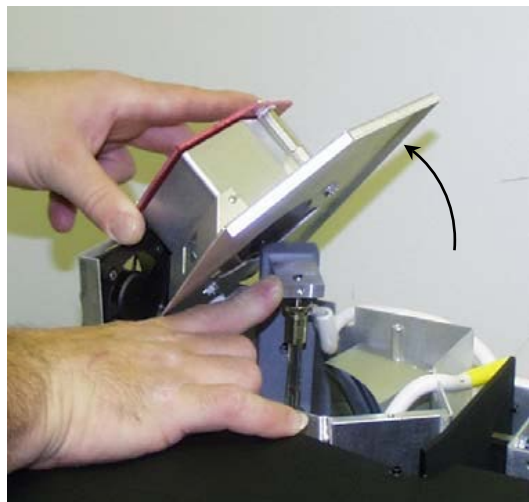

- e Rotate the cover backwards, and set it to the side of the instrument, so that electrical connections are not strained. The lamp is held in place by spring tension and the height adjustment on top of the lamp. The anode and cathode connections are attached to the lamp via thumbscrews on top and bottom of the lamp.

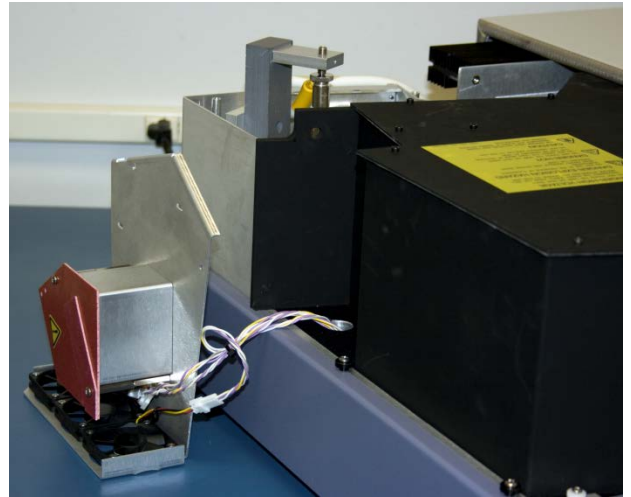

## 5 Prepare the replacement lamp.

- a Place the new xenon lamp (still in its protective cover) on top of the excitation monochromator.
- b Remove the top half of the new lamp's protective cover. Keep this top half handy for later.

## 6 Remove the old xenon lamp.

- a While holding the metal anode (top) portion of the lamp, loosen the height adjustment above the lamp with a 1/8" Allen key, until the lamp is removable.



- b Press down against the spring action. Notice how the nipple faces away from the collection mirror (not visible here behind the hand).



**Caution:** *Improper connections to the lamp severely affect lamp performance and affect the power supply. Carefully note the anode and cathode connections to the lamp. The anode (+) is on top; the cathode (-) is on the bottom. The nipple on the lamp's glass envelope marks the anode (+) side.*



- c Gently tilt the lamp away from the top post.
- d Lift the lamp out of the lamp housing far enough to remove the anode and cathode connections.
- e Remove the thumbscrew at the anode end (top) of the lamp, leaving the post exposed.
- f Remove the anode cable.
- g Remove the thumbscrew at the cathode end (bottom) of the lamp, leaving the post exposed.
- h Remove the cathode cable.

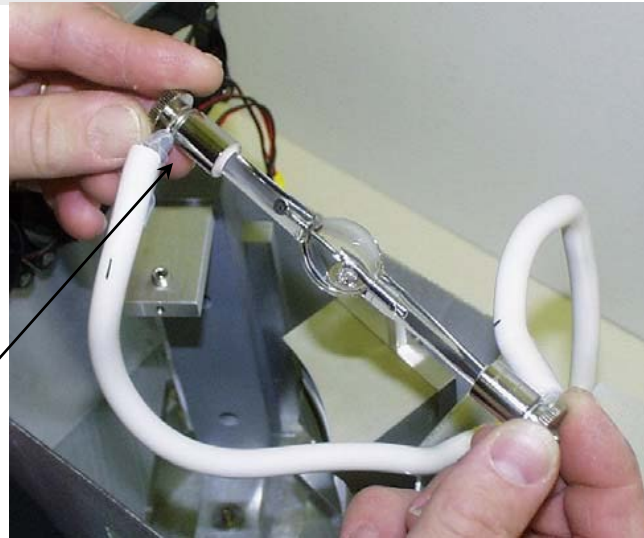

- 7 Place the old lamp in the top protective cover from the new lamp.



8 Put the old lamp (in the top cover) in a safe place.

9 Attach connections to the new lamp.

- a Attach the cathode connection to the new lamp, and secure the connection with the new lamp's thumbscrew.
- b Attach the anode connection to the new lamp, and secure the connection with the new lamp's thumbscrew.
- c Recheck that the connections are correct.



**Warning:** Do not touch any portion of the lamp except the metal cathode and anode.

10 Insert the new xenon lamp.

- a Insert the new lamp in the bottom holder.
- b Press the lamp down into the holder to compress the spring.
- c Tilt and raise the anode end of the lamp into the top holder.
- d Place the lamp so that the nipple on the glass envelope is opposite the collection mirror.
- e Set the height adjustment, using the 1/8" Allen key. Try to return the new lamp to the approximate position of the old lamp.

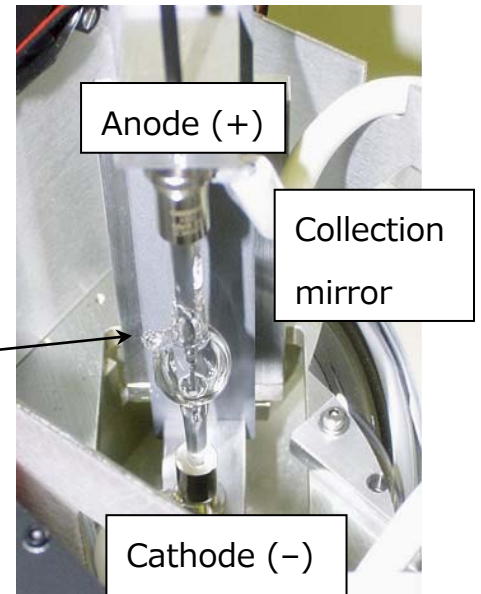

11 Replace the safety cover and lamp-housing cover.

12 Replace the three screws on the lamp-housing cover.

13 Reconnect all cables (power, accessories, etc.) to the FluoroMax<sup>®</sup> Plus.



**Note:** Do not replace the FluoroMax<sup>®</sup> Plus cover until the lamp is correctly adjusted.

## Adjusting the new xenon lamp

### Choices

There are two choices after lamp installation:

- Let the lamp “burn in”, i.e., run, for 6 h before adjustment of its position.
- Set the coarse lamp adjustments immediately. After a 6-h burn-in, set the fine adjustments.

For lamp replacement, the major adjustment is to optimize the height screw that was loosened to remove the old xenon lamp.

### Procedure

- 1 With the lamp cover still removed, turn on the FluoroMax<sup>®</sup> Plus.



**Caution:** Intense ultraviolet, visible, or infrared light may be present when the lamp cover is open, so wear eye- and skin-protection, such as light-protective goggles and light-blocking clothing.

- 2 Insert a clean cuvette filled with de-ionized water in the sample compartment.
- 3 With the room lights off and ambient stray light minimized, acquire a xenon-lamp scan and water-Raman scan, as explained in Chapter 3.

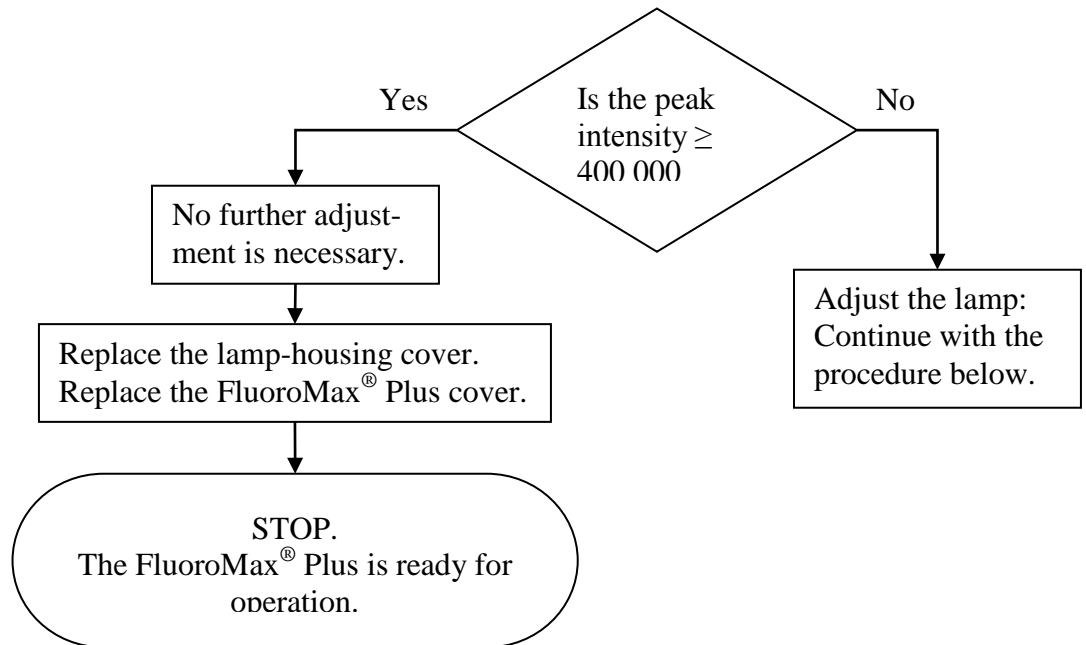

This should confirm that the instrument is roughly calibrated.

## 4 Open Real Time Control.

- a Move the excitation monochromator to 350 nm, and the emission monochromator to 397 nm.
- b Set the slits to 5-nm bandpass.
- c Open the excitation shutter and emission shutter.
- d Set the integration time to 0.5 s.

## 5 Adjust the xenon lamp's position.

There are three adjustments to optimize the lamp position:

Adjustment	Allen key required
Focus	3/32"
Tilt and Center	9/64"
Height	1/8"

- a Slowly work each adjustment to optimize the signal. At maximum signal (> 400 000 cps, depending upon the spectrometer), the lamp is optimized.
- b Remove the Allen keys.

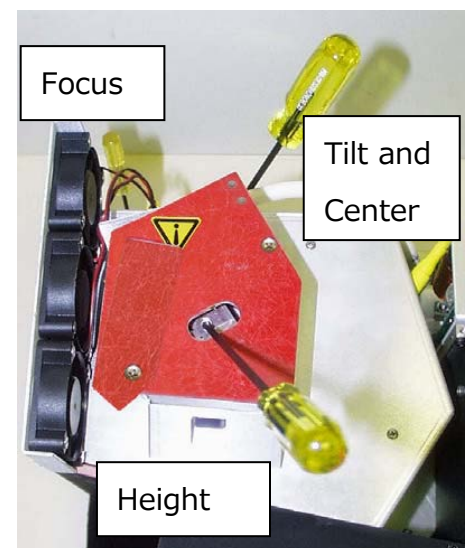

## 6 Acquire another water Raman scan.

- a Use the same parameters as in step 3.
- b Note the peak intensity.
- c Use the flowchart below.

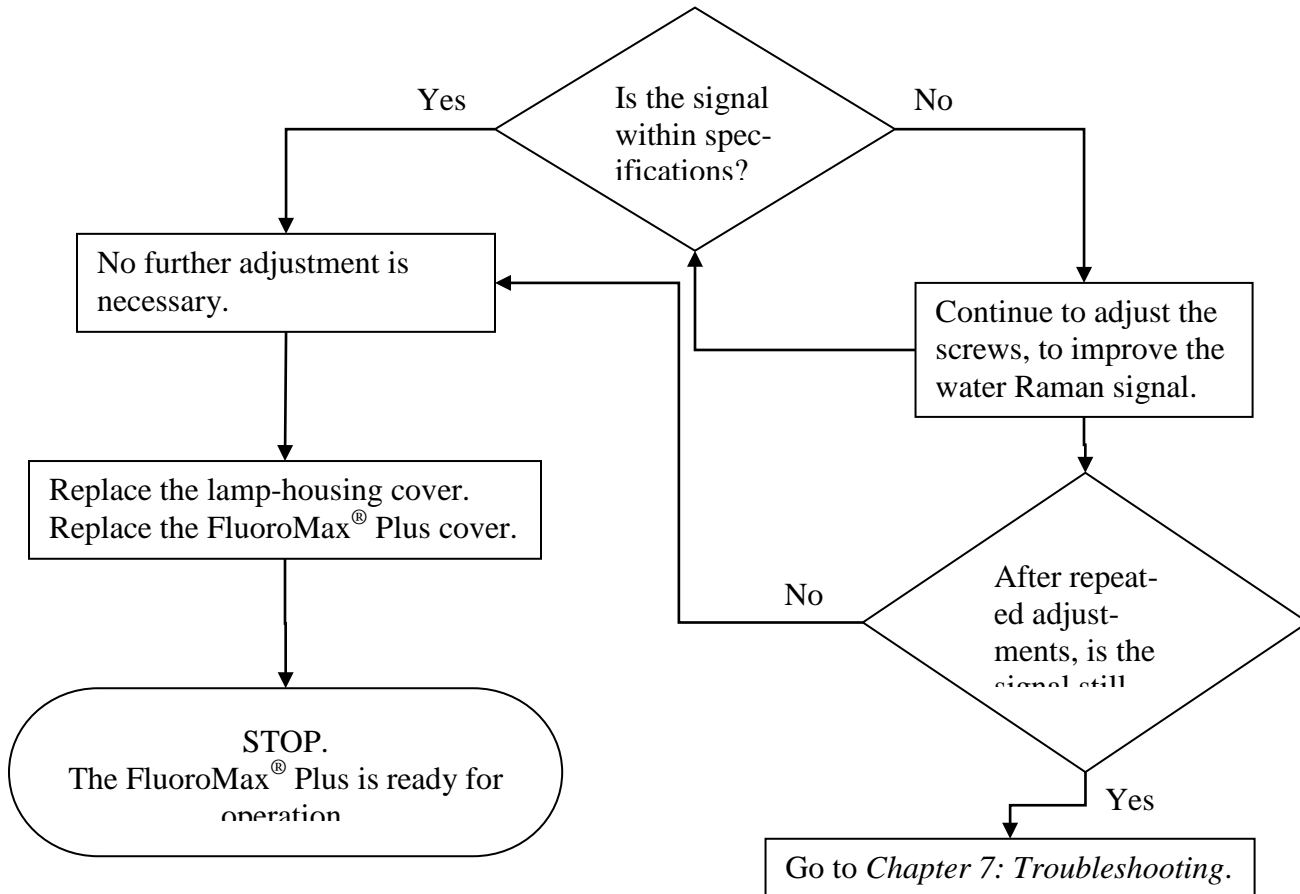

# Electronics

In case of the rare chance of system failure, this section is provided to help the user understand the electronics components.



**Caution:** *The information in this section does not constitute permission to adjust, manipulate, or remove any electrical or other components in the FluoroMax<sup>®</sup> Plus. This information is provided for reference purposes only. Contact the Service Department in case of system failure or suspected failure, before attempting repairs or testing with meters. DO NOT ATTEMPT ANY REPAIRS OR INSTRUMENT EVALUATION WITHOUT THE EXPRESS PERMISSION OF THE SERVICE DEPARTMENT.*

## Xenon-lamp power supply

The xenon lamp's power supply has a capacity of 180 W, and is found in the center back of the instrument. In order to suppress the emf spike emitted from the lamp's power supply during arcing and startup of the lamp—several thousand volts—this contains specialized line filters.

The power supply is preset at the factory for the correct current and voltage to supply the xenon lamp with 150 W. Poor lamp performance or difficulty maintaining a stable lamp arc may be the result of an improperly set power supply. Contact Fluorescence Service for more details.



## Monochromator drives and accessory controllers

The monochromator drives, drive electronics, and accessory electronics are found on the underside of the optical platform. Electrical connections for the emission detector and the basic system-electronics for AC-power conversion are also underneath the instrument.

To gain access to the drive electronics, remove the bottom cover of the instrument. Remove all screws on the bottom cover except those that attach the dust screens for the exhaust fans. The leveling feet do not need to be removed before detaching the bottom cover:

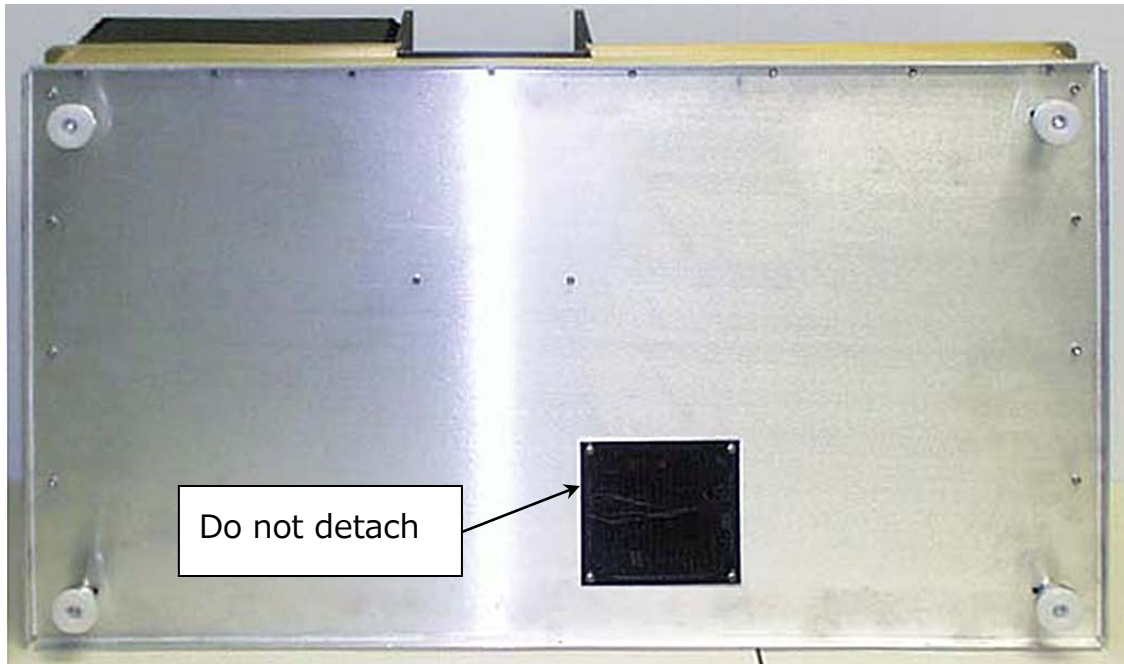

There is a J400906 control board underneath the instrument, which controls the drives, slits, shutter, and automated accessories in the monochromators. This board also controls options such as a sample changer.



**Caution:** *The information in this section does not constitute permission to adjust, manipulate, or remove any electrical or other components in the FluoroMax<sup>®</sup> Plus. This information is provided for reference purposes only. Contact the Service Department in case of system failure or suspected failure, before attempting repairs or testing with meters. DO NOT ATTEMPT ANY REPAIRS OR INSTRUMENT EVALUATION WITHOUT THE EXPRESS PERMISSION OF THE SERVICE DEPARTMENT.*

# Updating the FluoroMax<sup>®</sup> Plus Firmware

- 1 Turn on the host PC.
- 2 Insert the installation CD into the CD or DVD drive in the host PC.
- 3 Using Windows<sup>®</sup> Explorer, find the “Utilities” directory in the installation CD. Inside the “Utilities” directory, find the “HJYUpdate” subdirectory.
- 4 In the “HJYUpdate” subdirectory, double-click on HJYUpdate2.4.exe to start the firmware update.

The console window appears, asking you to choose which device:

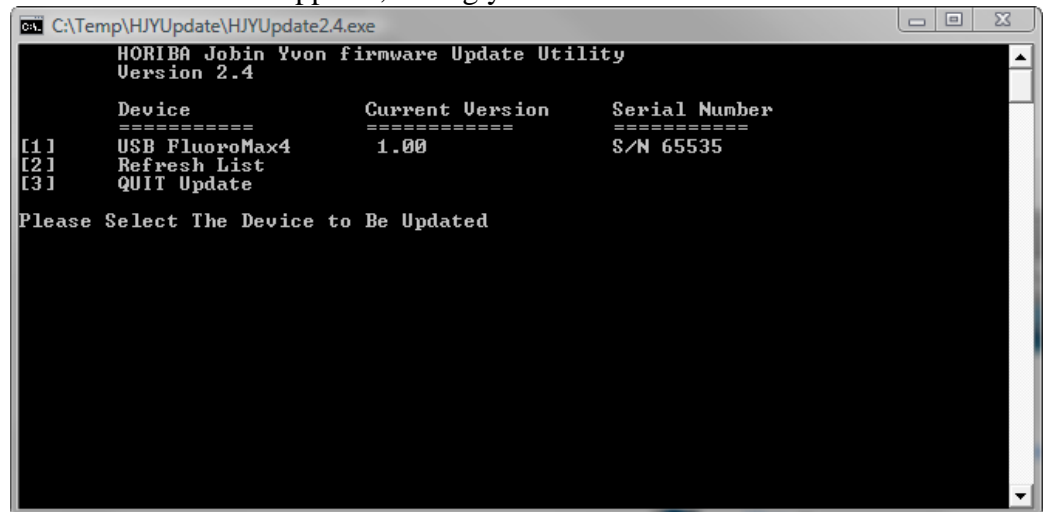

```
C:\Temp\HJYUpdate\HJYUpdate2.4.exe
HORIBA Jobin Yvon firmware Update Utility
Version 2.4

Device                Current Version      Serial Number
=====
[1]  USB FluoroMax4    1.00                S/N 65535
[2]  Refresh List
[3]  QUIT Update

Please Select The Device to Be Updated
```

- 5 Choose option 1 to update the FluoroMax<sup>®</sup> Plus with USB port and current firmware version 1.00.

The console asks you which choice: (1) update firmware, or (2) exit:

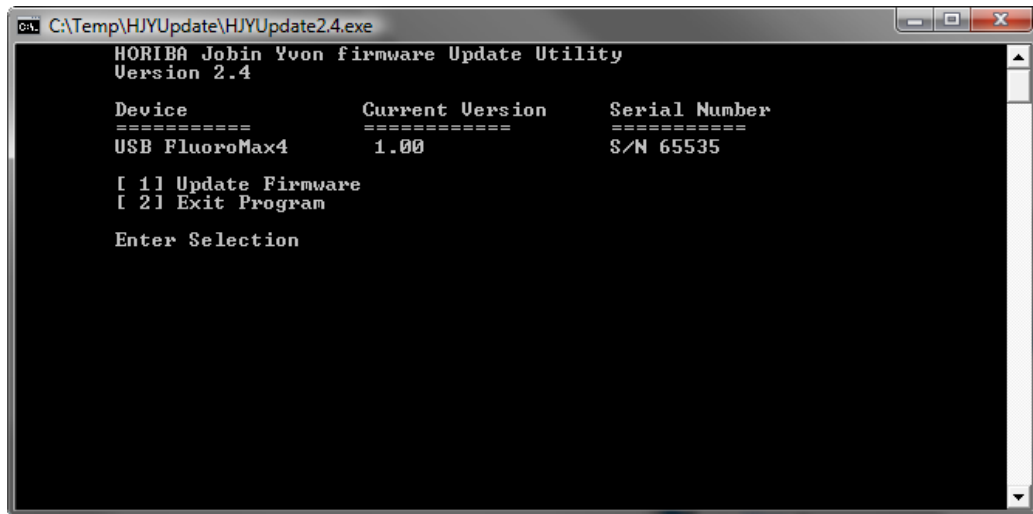

```
CA: C:\Temp\HJYUpdate\HJYUpdate2.4.exe
HORIBA Jobin Yvon firmware Update Utility
Version 2.4

Device          Current Version  Serial Number
=====
USB FluoroMax4  1.00           S/N 65535

[ 1] Update Firmware
[ 2] Exit Program

Enter Selection
```

## 6 Choose 1 to update the firmware.

The console asks you to confirm this choice:

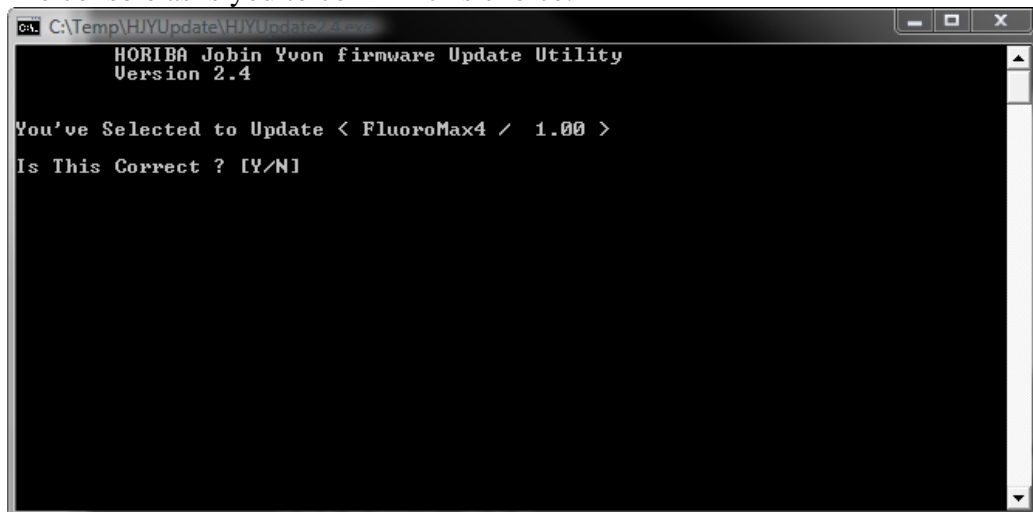

```
CA: C:\Temp\HJYUpdate\HJYUpdate2.4.exe
HORIBA Jobin Yvon firmware Update Utility
Version 2.4

You've Selected to Update < FluoroMax4 / 1.00 >
Is This Correct ? [Y/N]
```

## 7 Enter Y to confirm updating the firmware.

The console asks you to choose the firmware:



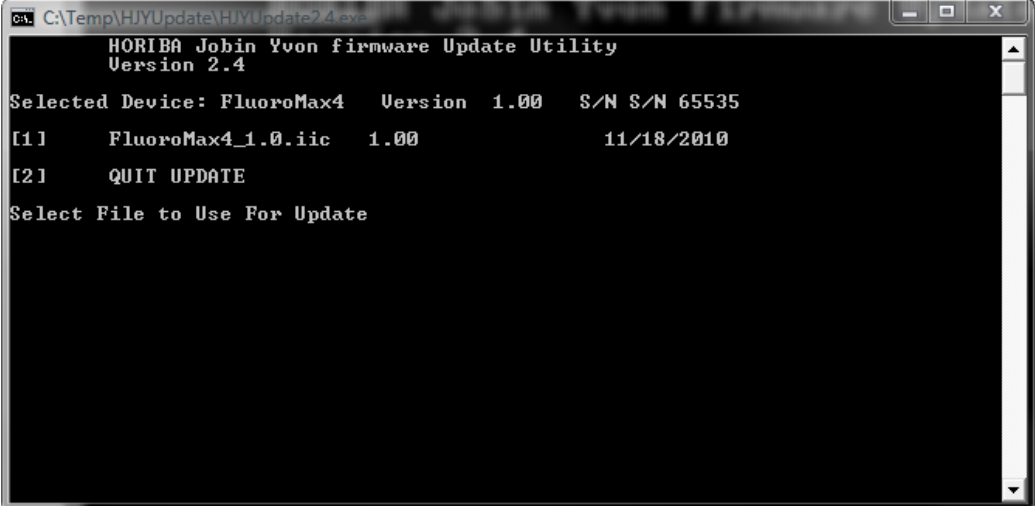

```
C:\Temp\HJYUpdate\HJYUpdate2.4.exe
HORIBA Jobin Yvon firmware Update Utility
Version 2.4
Selected Device: FluoroMax4 Version 1.00 S/N S/N 65535
[1] FluoroMax4_1.0.iic 1.00 11/18/2010
[2] QUIT UPDATE
Select File to Use For Update
```

8 Enter 1 for firmware FluoroMax4\_1.0.iic.

The console asks you to confirm that the new firmware version is 1.01:

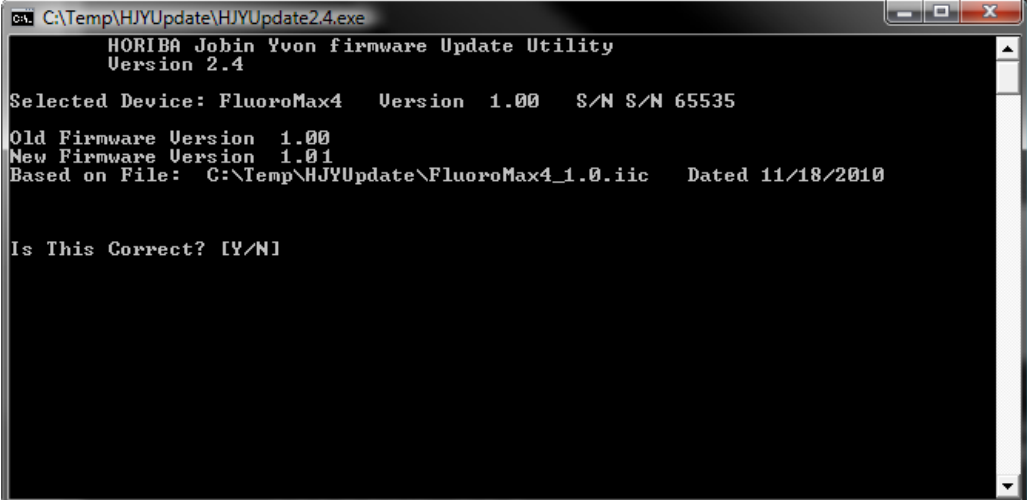

```
C:\Temp\HJYUpdate\HJYUpdate2.4.exe
HORIBA Jobin Yvon firmware Update Utility
Version 2.4
Selected Device: FluoroMax4 Version 1.00 S/N S/N 65535
Old Firmware Version 1.00
New Firmware Version 1.01
Based on File: C:\Temp\HJYUpdate\FluoroMax4_1.0.iic Dated 11/18/2010
Is This Correct? [Y/N]
```

9 Enter Y to confirm this.

The software updates the firmware. When complete, the console prompts you to press any key to close the program:

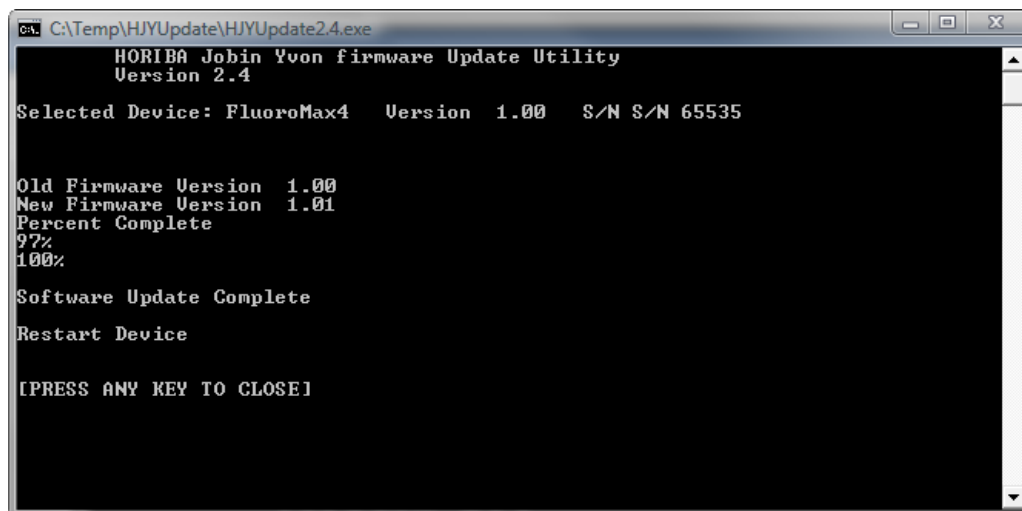
A screenshot of a Windows command prompt window titled "C:\Temp\HJYUpdate\HJYUpdate2.4.exe". The window displays the following text:

```
HORIBA Jobin Yvon firmware Update Utility
Version 2.4

Selected Device: FluoroMax4   Version 1.00   S/N S/N 65535

Old Firmware Version 1.00
New Firmware Version 1.01
Percent Complete
97%
100%

Software Update Complete

Restart Device

[PRESS ANY KEY TO CLOSE]
```

- 10 Switch off the FluoroMax<sup>®</sup> Plus for about 10 seconds, and then switch it back on to load the firmware into the instrument.

# 7 : Troubleshooting

The FluoroMax<sup>®</sup> Plus system has been designed to operate reliably and predictably. If there is a problem, examine the chart below, and try the steps on the following pages.

Problem	Possible Cause	Remedy
<b>Light is not reaching the sample.</b>	Excitation shutter closed.	Using the software, open the shutter.
	Slits are not open to the proper width.	Adjust the slits.
	FluoroMax <sup>®</sup> Plus is in phosphorimeter layout.	Change to a steady-state layout.
	Monochromator is miscalibrated.	Check and recalibrate monochromator.
	Sample turret is not in correct position.	Using FluorEssence <sup>™</sup> , set the position and open the cover to verify the position.
<b>Signal intensity is low.</b>	CW lamp is not aligned.	Align the lamp.
	Slits are improperly set.	Adjust the slit widths.
	Shutter(s) is(are) not completely open.	Open the shutter(s) in <b>Real Time Control</b> .
	Lamp power-supply is set to the wrong current rating.	Call the Service Department.
	Lamp is too old.	Replace lamp. (150-W lamp has lamp lifetime 1200–1500 h.)
	Shutter(s) closed.	Open all shutters in <b>Real Time Control</b> .
	<b>Signal intensity is at least 10 times lower than normal.</b>	Polarizer is in the light path.
Monochromators are set to wrong wavelength.		Select appropriate wavelength based on excitation and emission of sample.
Detectors are saturated.		Adjust slits. (Signal detector is linear to $2 \times 10^6$ cps in photon-counting mode. Reference detector saturates at 200 $\mu$ A.)
Optical density effects and self-absorption.		Sample is too concentrated. Dilute sample by a factor of 10 or 100 and

		retry experiment.
<b>No change in signal intensity.</b>	Detectors are saturated.	Reduce slit settings.
<b>No signal.</b>	Lamp is not on.	Bad lamp: change xenon lamp.
	Detectors are saturated.	Reduce slit settings.
<b>Erratic signal.</b>	Lamp unstable.	Let lamp warm up 20 min before use.
	Light leaks.	Check dark value to determine.
	Sample has particles that scatter light irregularly.	Filter sample, or let particles settle before running scan.
<b>Raman band superimposed on fluorescence scan.</b>	Aqueous solutions and solvents have Raman bands.	Change excitation wavelength to move Raman band away from fluorescence peak, or run a blank scan of the solvent and subtract it from the fluorescence spectrum.
<b>Large off-scale peak at twice the excitation wavelength.</b>	Second-order effects from the spectrometer.	Use cut-on filters to eliminate 2 <sup>nd</sup> -order peak.
<b>Stray light in emission scan (also see example in this chapter).</b>	Scattered light off the excitation wavelength.	Place bandpass filters in excitation light path.
	Dirty cuvette.	Decrease emission-spectrometer slit widths.
	Solid-sample holder in sample compartment.	Clean the cuvette as described in Chapter 5.
		Rotate the holder to prevent direct scatter from entering the emission spectrometer.
<b>Corrected excitation spectrum curves upward ~240–270 nm.</b>	Dark count is divided by low reference signal.	Use Dark Offset checkbox; retry scan.
<b>Noisy spectrum with magnetic stirrer.</b>	Stirring speed is too fast.	Use slower stirring speed.
	Stirring bar is too large; light beam is striking it.	Use a smaller stirring bar (available from Bel-Art Products, Pequannock, NJ).
<b>Communication problems between computer and instrument.</b>	USB cable is improperly connected.	Check USB cable's connection.

<b>Hardware Init. Error appears.</b>	Broken IR sensor in monochromator.	Replace IR sensor: Call the Service Department.
<b>Sample turret is not operating.</b>	Software is not enabled. USB cable is connected improperly.	Check status. Check USB cable's connection.
<b>FluoroMax<sup>®</sup> Plus resets itself in phosphorimeter mode.</b>	Flash lamp's life is expired, drawing excess current, causing transient emf interference.	Replace xenon flash lamp.
<b>"Data file does not exist" or "file read error" message appears</b>	User is not logged into Windows <sup>®</sup> as administrator or power user	Log into Windows <sup>®</sup> as administrator and or power user, and restart FluorEssence <sup>™</sup>

# Using diagnostic spectra

Often the spectrum reveals information regarding the hardware or software parameters that should be adjusted. The following spectra occur with explanations about problems leading to their appearance.



**Note:** Not all spectra shown in this section were produced using the FluoroMax<sup>®</sup> Plus. The spectra are presented to show different possible system or sample problems, and may not reflect the performance of your particular FluoroMax<sup>®</sup> Plus.

## Lamp scan

Running a lamp scan verifies system integrity and indicates whether the correct parameters for the best possible trace are being used. The following spectrum shows the trace resulting from a lamp scan run with a known good lamp.

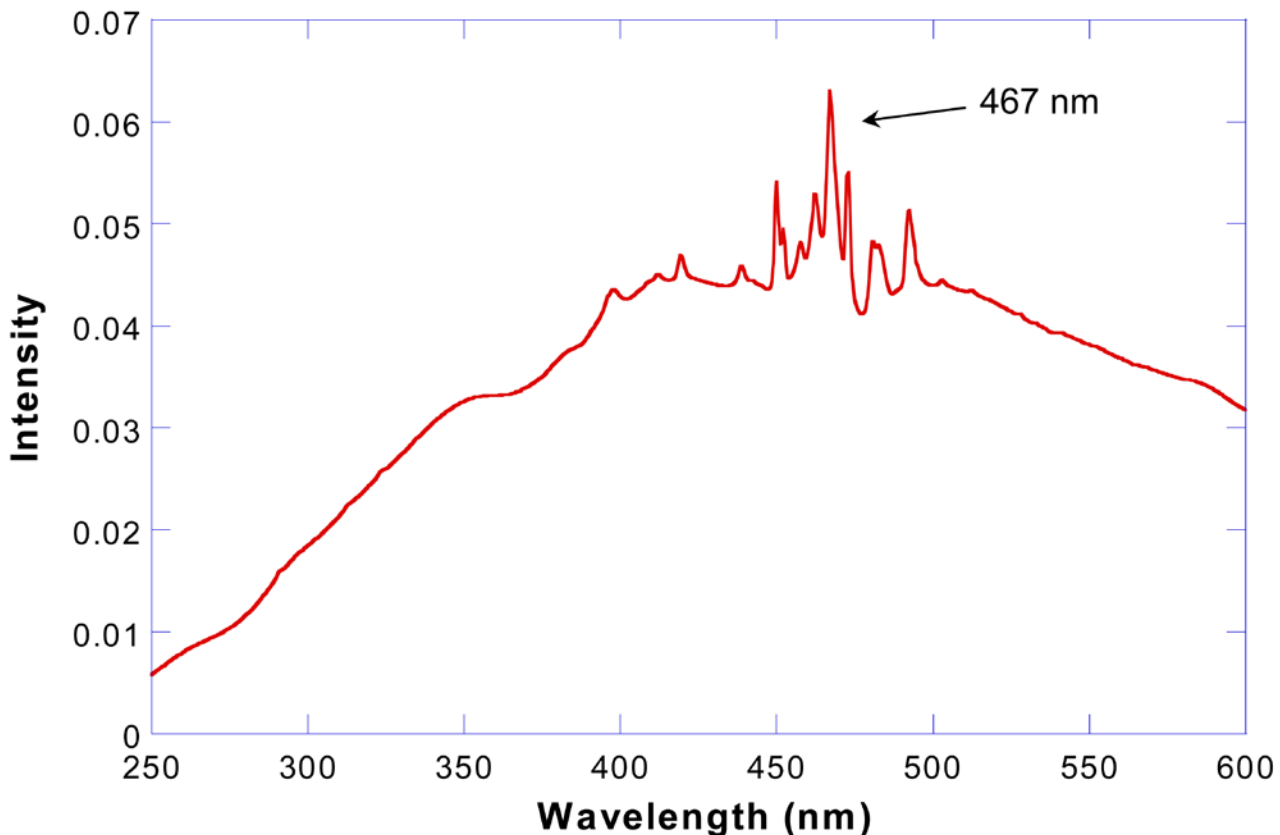

Scan of good quality 150 W xenon lamp in FluoroMax<sup>®</sup> Plus.

The following lamp-scan spectrum shows poor resolution in the area around the peak.

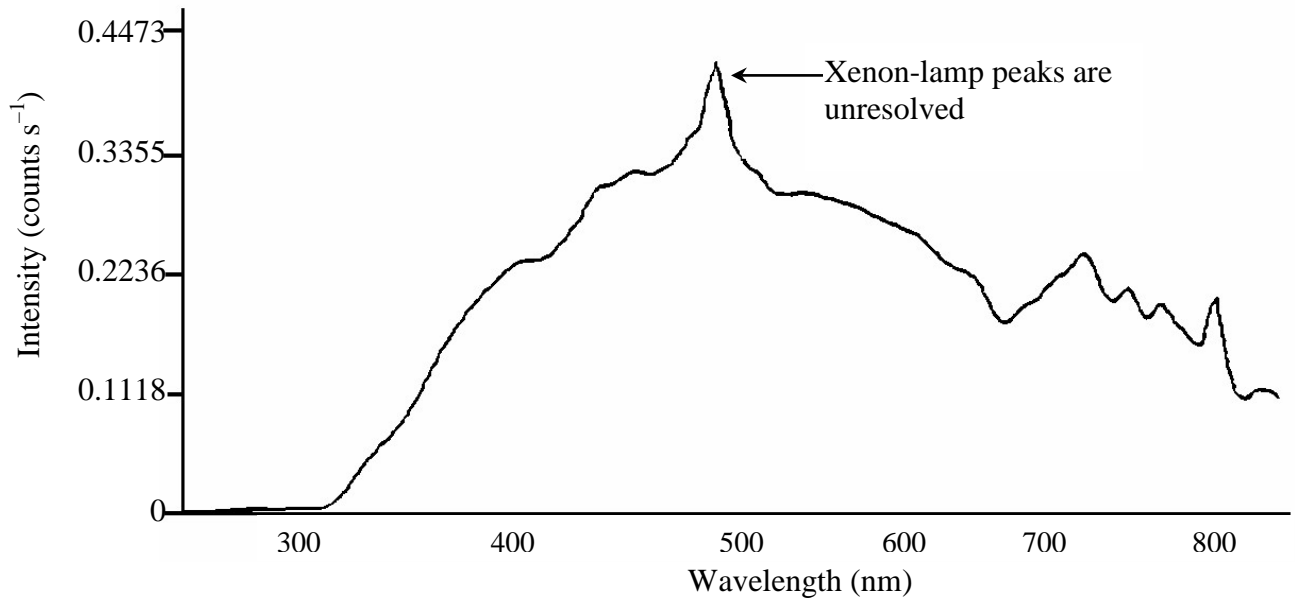

**Poor lamp scan of 150-W Xe lamp. Note low resolution in the area near the 467-nm peak.**

This lack of spectral resolution appears because the slit widths are set too wide. To resolve this problem, narrow the slit-widths.

## Water Raman spectra

### Contaminated water

Running a water Raman scan helps identify abnormalities caused by accessory problems or miscalibration. The following spectrum is normal:

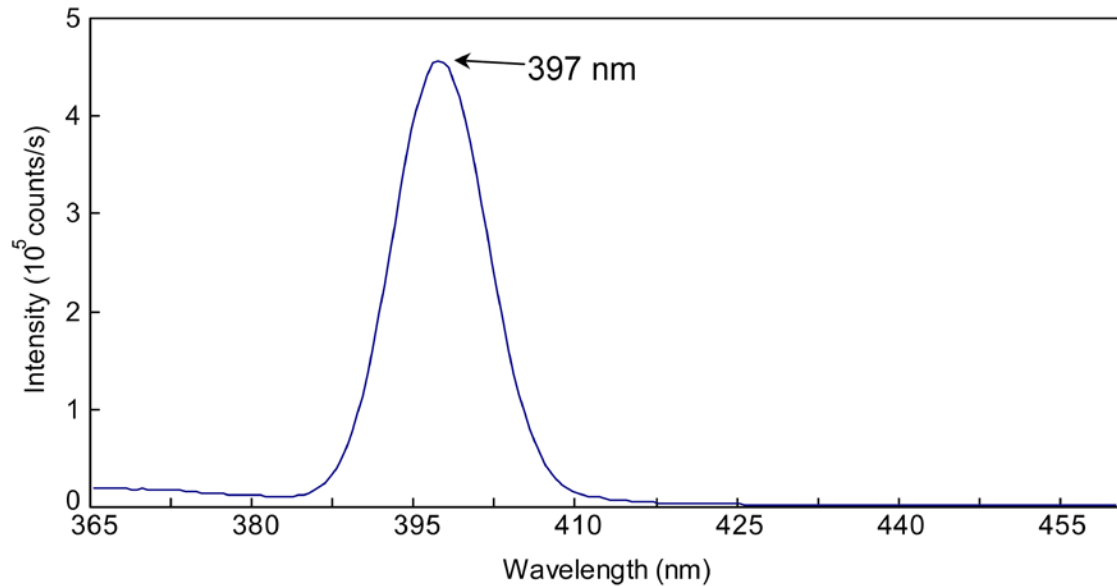

**Clean water Raman scan.**

Below is a normal water Raman spectrum superimposed on one that exhibits a problem.

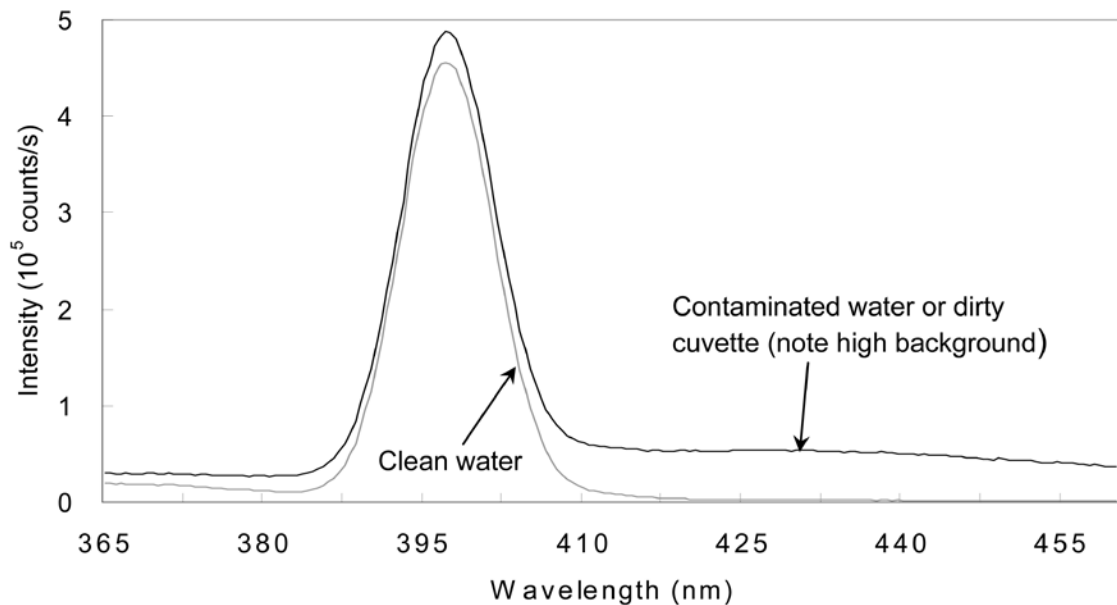

**Contaminated water in a water Raman scan.**

In this instance, the water was contaminated, resulting in a high background. If a spectrum similar to this is obtained after running a water Raman scan,



# 1 Rotate the cuvette 90° and rerun the scan.

If the problem goes away, then the problem was due to the cuvette surface. Clean or use a different cuvette.

Or

# 1 Clean the cuvette.

# 2 Fill with fresh, double-distilled, de-ionized water.

If the problem goes away, then the problem was due to contaminated water.

## Light not striking cuvette

The following graph shows a normal water-Raman scan with a superimposed problem scan.

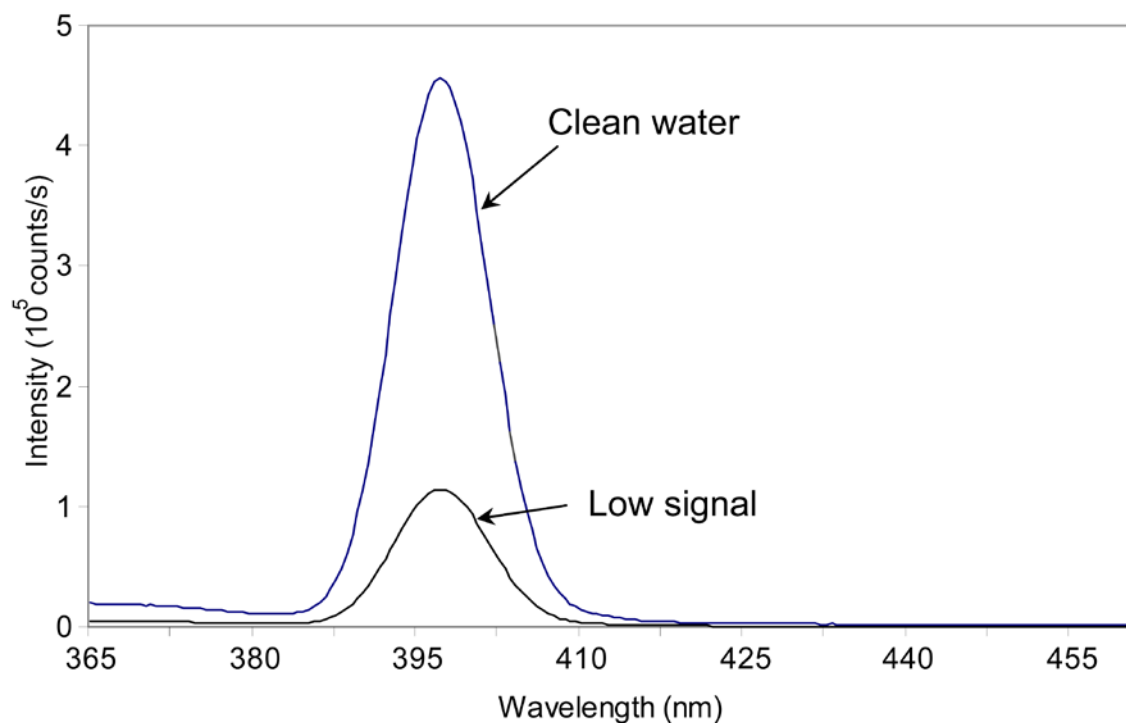

## Low intensity during a Raman scan.

Here the problem is low intensity of the water signal when compared with the superimposed typical water Raman scan. To resolve this problem:

# 1 Make sure the cuvette is filled to the proper level.

Light should fall on the sample, and the meniscus should not be in the light path.

## 2 Make sure that the excitation and emission slits are set to the proper widths.

### Stray light

In the following diagram, notice the high level of stray-light below 380 nm in the water-Raman spectrum.

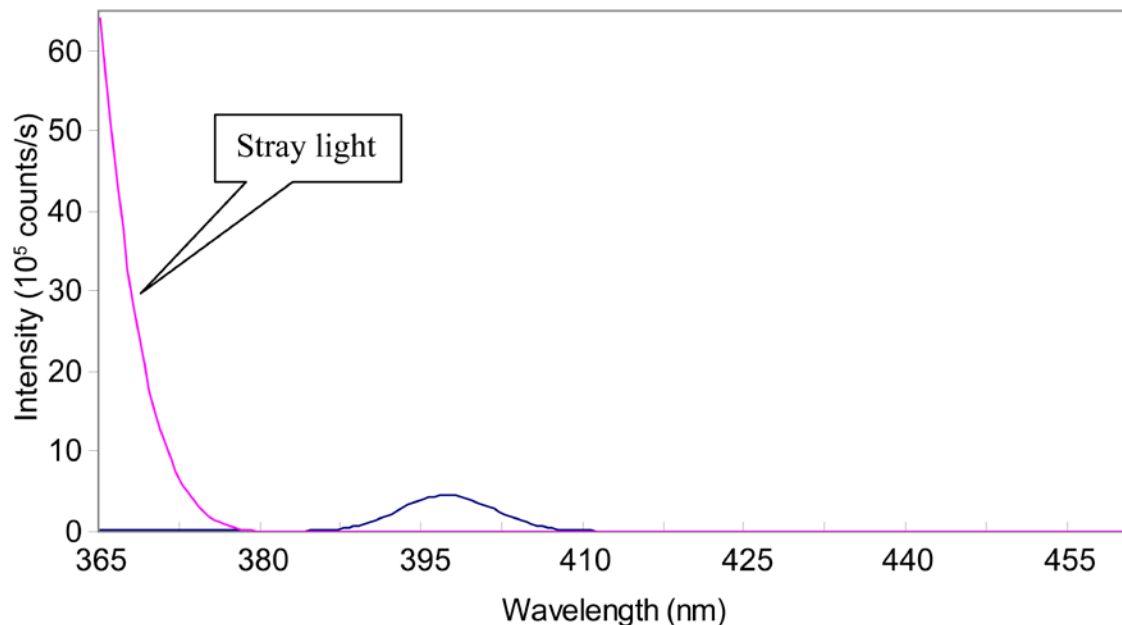

### High stray light in a water Raman scan.

To correct this problem,

- 1 Inspect the cuvette surface for fingerprints and scratches.
- 2 Clean the cuvette or use a new one.
- 3 Verify that the excitation and emission slits are set correctly for a water-Raman scan.
- 4 Verify that the excitation monochromator is at the correct position.

## Further assistance...

Read all software and accessory manuals before contacting the Service Department. Often the manuals show the problem's cause and a method of solution. Technical support is available for both hardware and software troubleshooting. Before contacting the service department, however, complete the following steps.

- 1 If this is the first time the problem has occurred, try turning off the system and accessories.

After a cool-down period, turn everything back on.

- 2 Make sure all accessories are properly configured, and turned on as needed.

- 3 Following the instructions in Chapter 3, System Operation, run a lamp scan and a water Raman scan to make sure the system is properly calibrated.

Print the spectrum for each and note the peak intensities.

- 4 Check this chapter to see if the problem is discussed.

- 5 Try to duplicate the problem and write down the steps required to do so.

The service engineers will try to do the same with a test system. Depending on the problem, a service visit may not be required.

- 6 If an error dialog box appears in FluorEssence™, write down the exact error displayed.

- 7 In FluorEssence™, in the FluorEssence main window's toolbar, choose Help:

A drop-down menu appears.

- 8 Under Help, choose

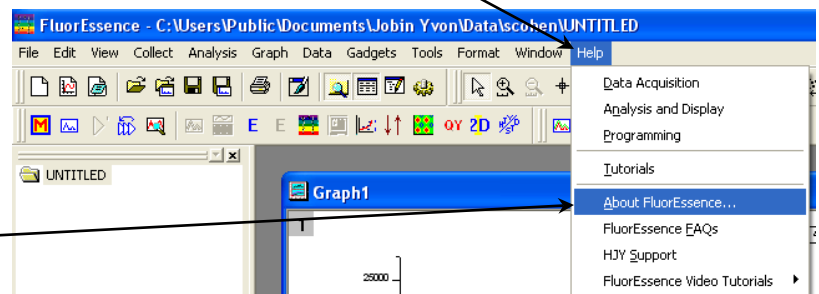

## About FluorEssence....

This opens the **About FluorEssence** window:

The version of the software (both FluorEssence™ and Origin®) is listed here.

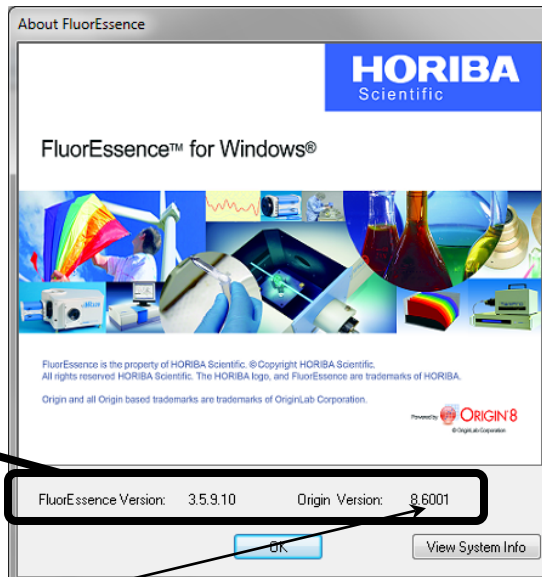

- 9 Click the **View System Info** button.

The **Installed Components** window appears, displaying all the software required for FluorEssence™.

- 10 Record the information by clicking the:

- **Save To File...** button, which saves the information to a file;
- **Zip Info** button, compresses the information while saving it;
- **Print Info** button, which prints out the software information.

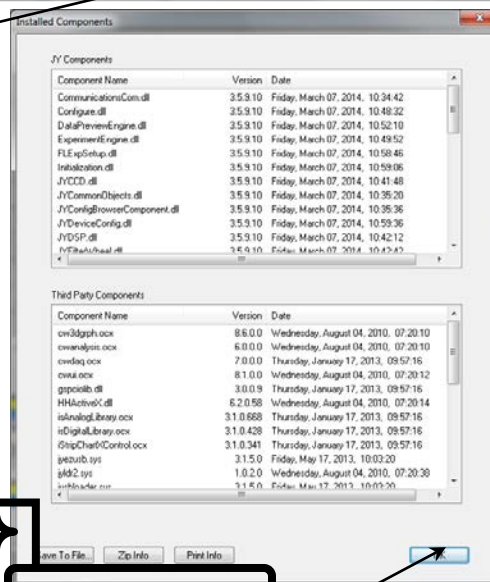

- 11 Click the **OK** button to close the **Installed Components** window.

- 12 Click the **OK** button to close the **About FluorEssence** window.

- 13 Write down the software's version numbers, along with the purchase dates, model numbers, system configuration, and serial numbers of the instrument and its accessories.

# 14 Determine the SpectrAcq firmware version:

a Open the **Experiment Setup** window:



b Click the **Detectors** icon

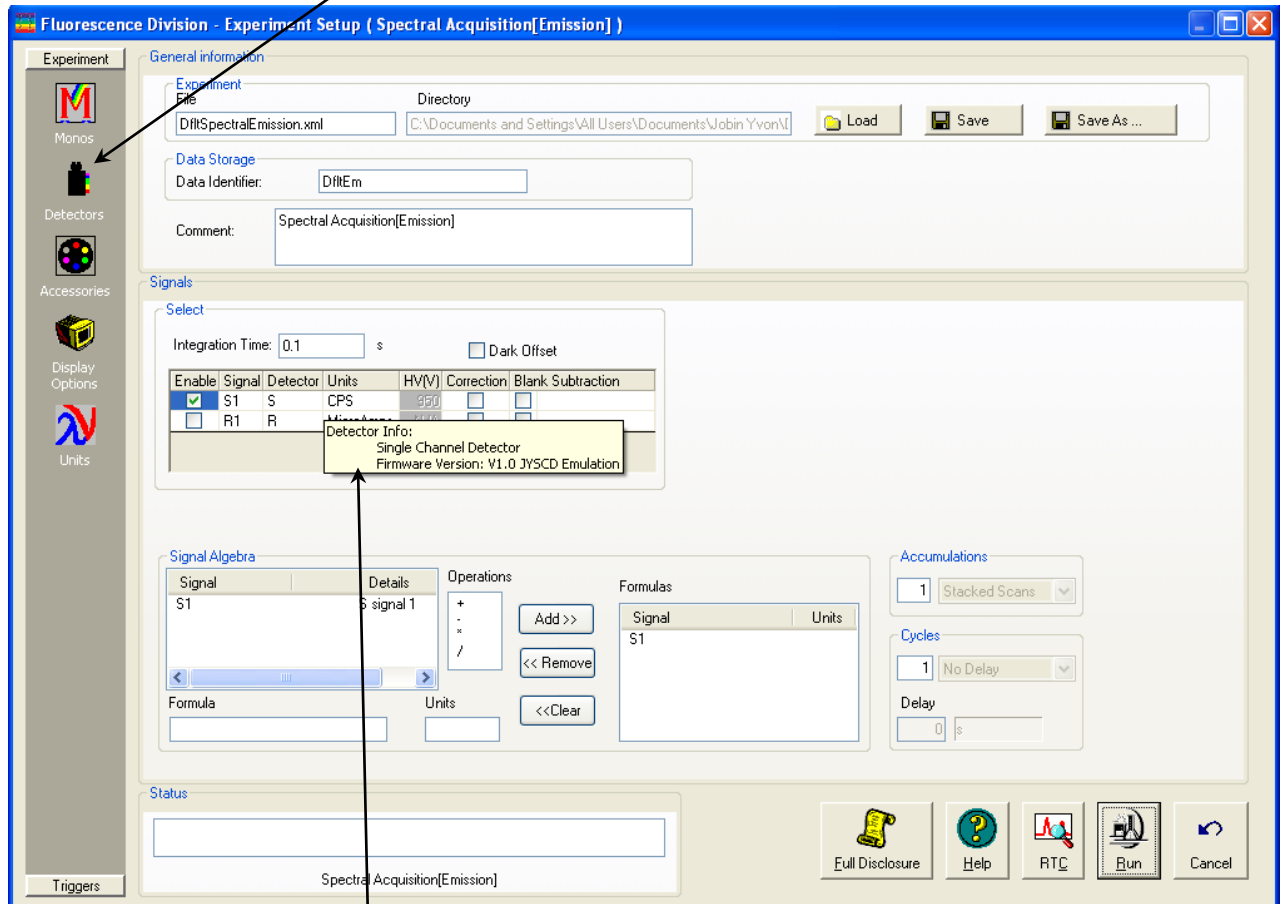

c Move the mouse over the detectors' table in the **Select** area. The SpectrAcq firmware version appears in a small pop-up window:

If the problem persists or is unlisted, call the Service Department at (732) 494-8660 × 8160.



# 8 : Producing Correction Factors

## Introduction

Gratings, detectors and other spectrometer components have response characteristics that are functions of wavelength. These characteristics are superimposed on spectra, and may yield a potentially misleading trace. For accurate intensity comparisons, such as those required for quantum-yield determinations, spectrometer-response characteristics must be eliminated. Corrections are made for each of these potential problems by using radiometric correction factors.

Supplied with the FluoroMax<sup>®</sup> Plus are sets of excitation and emission correction factors designed to eliminate response characteristics. These files, `xcorrect.spc` and `mcorrect.spc`, are included with the software and should be copied to the hard disk. The excitation correction range is from 240–850 nm, and the correction range for emission spectra is from 290–850 nm.

# Generating emission correction factors

Generate a new correction-factor file only when the gratings or detectors have been replaced with those of different specifications than the original hardware.

## Required kits

Emission correction factors should be updated periodically or whenever different gratings or signal detectors are installed. The correction factors can be updated either at the user's location, or by a representative from the Service Department. To arrange for a visit and a fee estimate, call the Service Department. To update the correction factors without a service visit, call the Service Department for instructions and further information.

One way to generate correction factors for the instrument is to scan the spectrum of a standard lamp. Because the actual irradiance values of the standard lamp as a function of wavelength are known, dividing the irradiance values by the lamp spectrum results in a set of relative correction values. These values can then be applied to the raw fluorescence data. The emission correction factor file `mcorrect.spc` was acquired in this manner.

To generate emission correction factors, several items are needed: a standard lamp, appropriate holders, and a light-scattering assembly. HORIBA Scientific offers the F-3026 Standard Lamp Accessory.

The F-3026 Standard Lamp Assembly is a complete correction-factor kit, which includes the following items:

- Calibrated lamp
- Irradiance values for the calibrated lamp
- Power supply
- Neutral-density filter
- Sample-compartment cover



# Calculating emission correction factors

## Introduction

For more information about the theory and application of radiometric correction, consult *Accuracy in Spectrophotometry and Luminescence Measurements*, Mavrodineau, Schultz, and Menis, NBS Spec. Publ. 378 (1973), especially p. 137, “Absolute Spectrofluorometry,” by W.H. Melhuish.

Irradiance values for a standard lamp, packaged with the lamp, usually are expressed in  $10^{-6} \text{ W} \cdot \text{cm}^{-2} \cdot \text{nm}$ . With photon-counting systems like the FluoroMax<sup>®</sup> Plus spectrofluorometer, however, data usually are collected in units of  $\text{photons} \cdot \text{s}^{-1} \cdot \text{cm}^{-2} \cdot \text{nm}$ . To convert the units, multiply each irradiance value by the wavelength at which it is valid. (The data will still be off by a factor of  $c$ , but normalizing the correction factors compensates for this.) Such a mathematical procedure can be done in a spreadsheet program.

### 1 Load the irradiance values.

- a Enter the irradiance values into a spreadsheet. Load the irradiance file supplied by HORIBA Scientific by opening the FluorEssence<sup>™</sup> software, choose **File** in the toolbar, choose **Import**, and then choose **SPC** file.
- b Save the file as **IRR**.

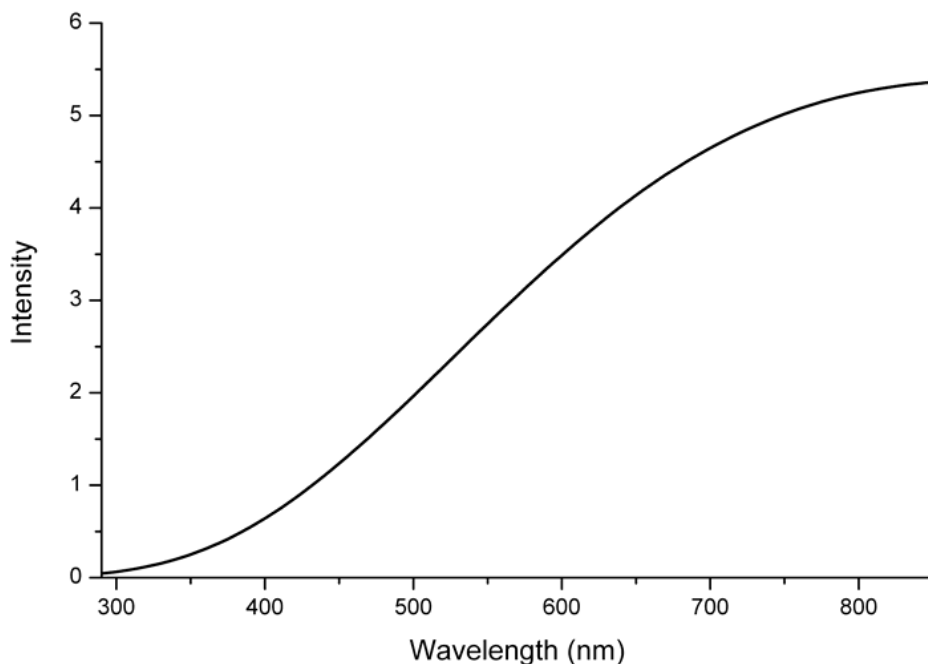

Now you have the two files: **IRR** and **stdlamp2**. These files are required to calculate the emission correction factors for the FluoroMax<sup>®</sup> Plus.

## 2 Calculate the correction factors.

Using the **Simple Math Tool** window under the **Analysis/HJY Tools** menu, divide IRR by `stdlamp2`, and name the resulting file `mcorrect`:

$$mcorrect = \frac{IRR}{stdlamp2}$$



**Note:** Naming the file `mcorrect` overwrites the `mcorrect` file supplied with the software.

## 3 Normalize the new `mcorrect` file.

a Using the **HJY\_normalize** window under the **Analysis/HJY Tools** menu, divide the `mcorrect` file by this minimum signal intensity, a constant.

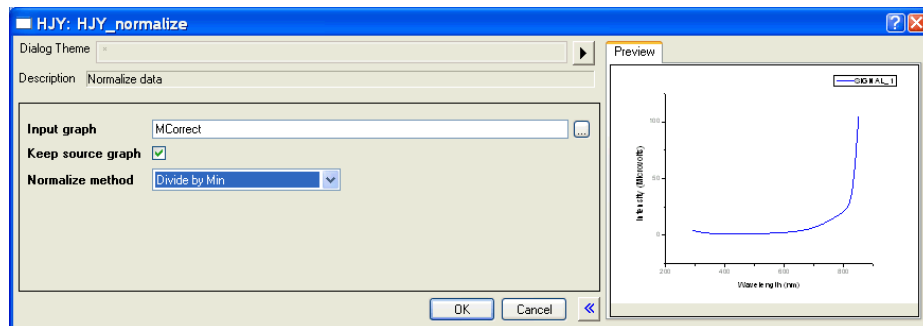

b Save this new file as `mcorrect`.

(That is, overwrite the existing `mcorrect` file.) This normalizes the correction factor file so that the minimum intensity of `mcorrect` will be 1 count  $s^{-1}$ . `mcorrect` contains the emission correction factors for the system. The correction-factor file should look similar to this:

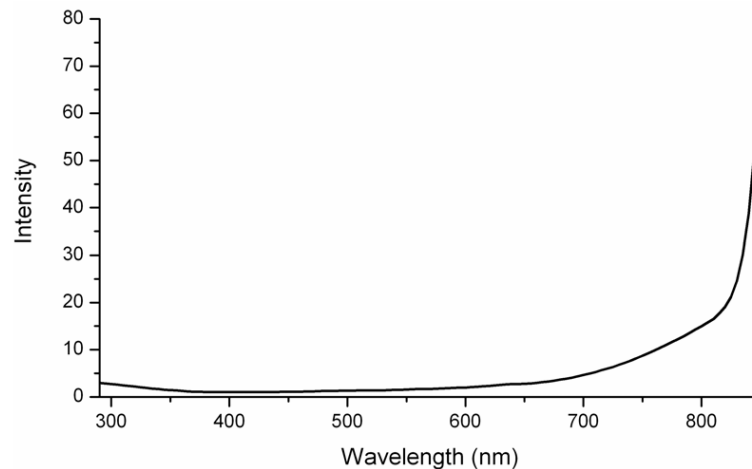

Once the emission correction factors are found, determination of the excitation correction factors may be necessary. The following procedures describe how to obtain excitation correction factors using the photomultiplier and the photodiode. Follow the procedure that applies to your configuration.

# Calculating emission correction factors

Set up the F-3026 accessory.

- 1 Attach the correction-factor light-source to its gap-bed with the brass thumbscrews.

Use this orientation. Be sure the power cable doesn't block optical apertures.

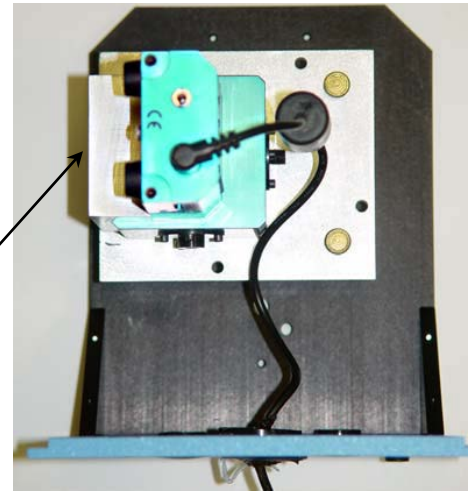

**Note:** The source/integrating-sphere module may arrive pre-mounted atop the special gap-bed.

- 2 Plug the power cable into the front of the gap-bed.
- 3 Remove the standard sample-compartment gap-bed, and insert the correction-factor kit gap-bed into the sample compartment.

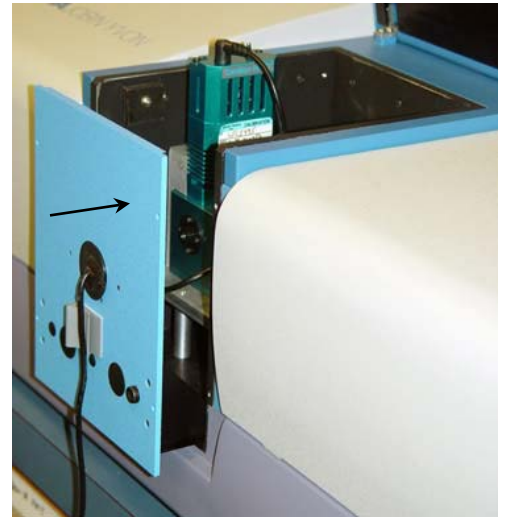

Fix the gap-bed firmly to the sample compartment with screws through the front panel.

Run the scan.

- 1 Start FluorEssence<sup>™</sup> and initialize the instrument.

Turn the xenon lamp OFF, and the lamp for the correction-factor kit ON.

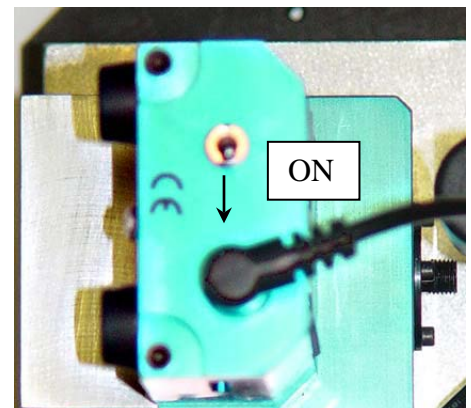



**Warning:** Wear appropriate eye-protection against UV, visible, and IR when the tungsten-halogen lamp is on and the sample-compartment is uncovered.



**Note:** We recommend keeping a log of the amount of time the source is on. Calibration is necessary after every 50 h of use.

## 2 Put the raised lid on the sample compartment.

Make sure it fits securely, and there is no light leak into the sample compartment.



**Caution:** Do not operate the accessory without the lid completely covering the sample compartment.



## 3 Collect an emission scan using the following scan parameters:

Range: 290–850 nm; increment: 5 nm; integration time: 1 s

## Analyze the data.

- 1 Using the **HJY\_simple\_math** window under the **Analysis/HJY Tools** menu, divide the **irrad** file by the **stdlamp** file:

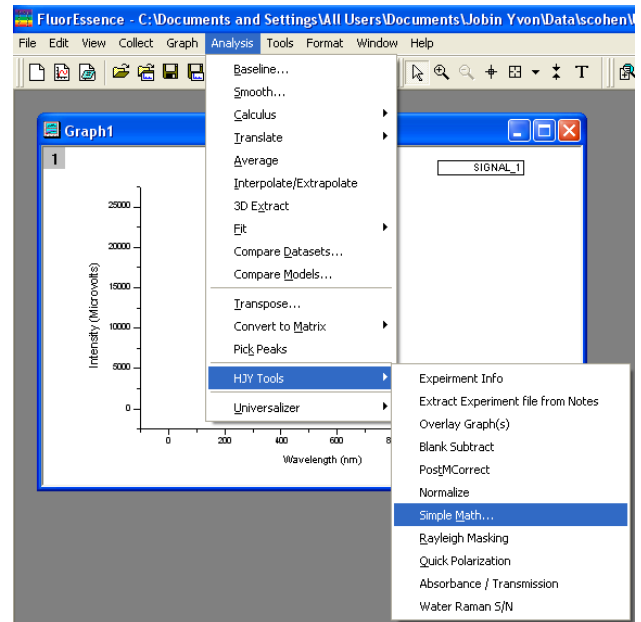

**Note:** Choose the correct irradiance file associated with the desired detector.

The **irrad** file is the irradiance file associated with the detector.

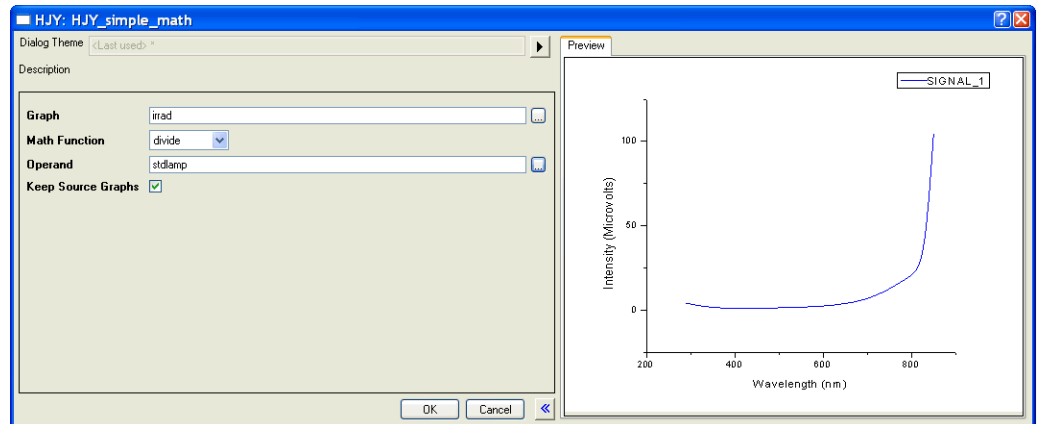

The new graph now displays the correction factor.

## 2 Normalize the new **mcorrect** file.

- a Using the **HJY\_normalize** window under the **Analysis/HJY Tools** menu, divide the **irrad** file by this minimum signal intensity, a constant.

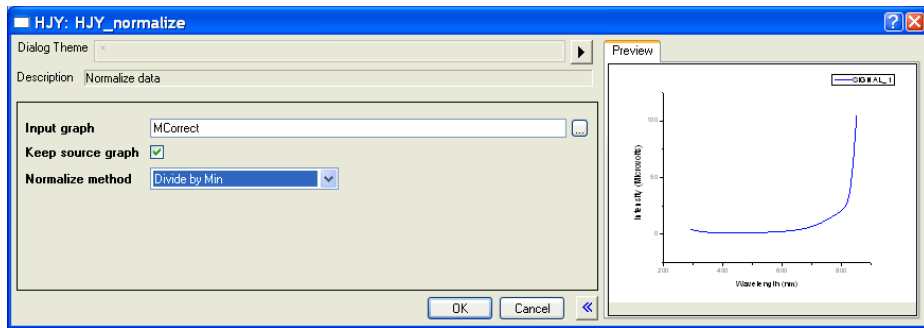

- b Save this new file as `irrad2`.  
This normalizes the correction factor file so that the minimum intensity will be 1 count s<sup>-1</sup>. Highlight the B(Y) column, right-click and select Normalize.

3 Export the normalized correction-factor graph.

In the **File** menu, click **Export**, and select **SPC Data....**

4 Apply the correction factor into your system configuration by following the instructions in your instrument manual.

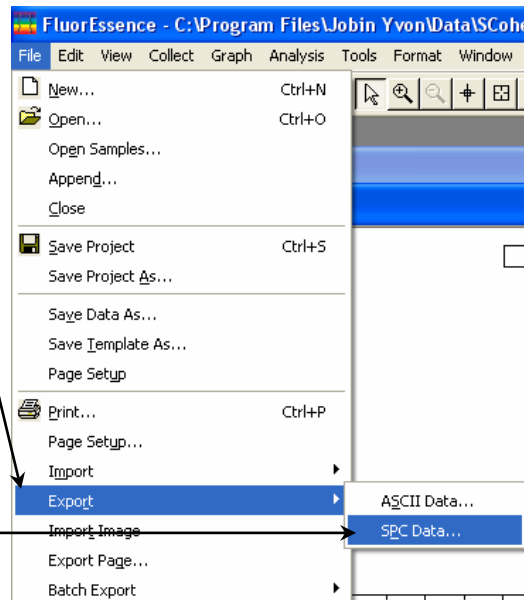

Remove the accessory.

1 Remove the sample-compartment cover.



**Warning:** Wear appropriate eye-protection against UV, visible, and IR when the tungsten-halogen lamp is on and the sample-compartment is uncovered.

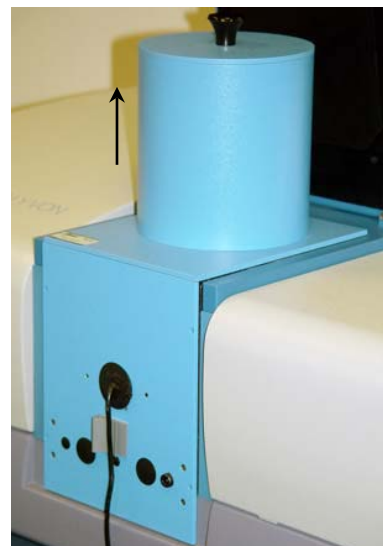

2 Turn OFF the accessory.



*Caution:*  
The accessory may be HOT. Let the accessory cool before removal!

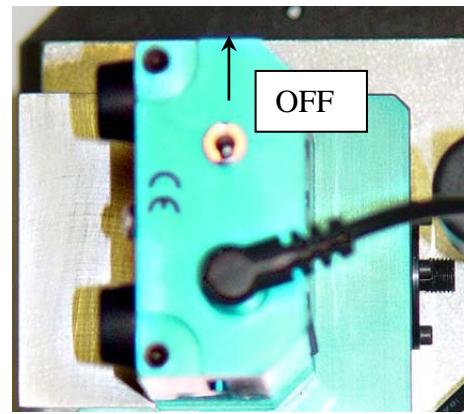

*Note:* We recommend keeping a log of the amount of time the source is on. Calibration is necessary after every 50 h of use.

3 Remove the accessory's sample-compartment gap-bed, and return the standard gap-bed to the sample compartment.

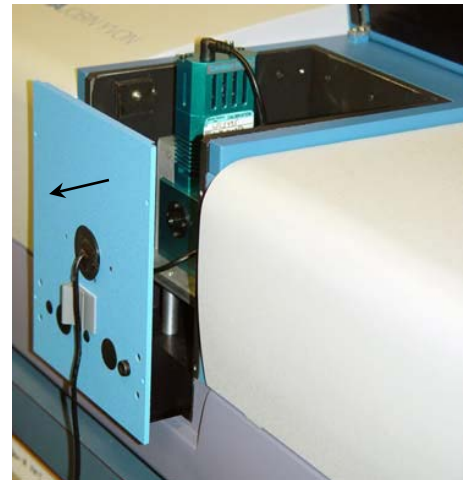

# Using correction-factor files

To use the newly acquired `xcorrect` and `mcorrect` files, you must tell FluorEssence™ to use them when the Correction checkbox is activated in the Experiment Setup window.

- 1 In the FluorEssence toolbar, choose Collect.

A drop-down menu appears.

- 2 Choose Advanced Setup.

A sub-menu appears.

- 3 Click System Configuration.

If the system has not been initialized, choose the instrument, and let the system initialize. Then redo steps 1–3. The **System Configuration** window appears.

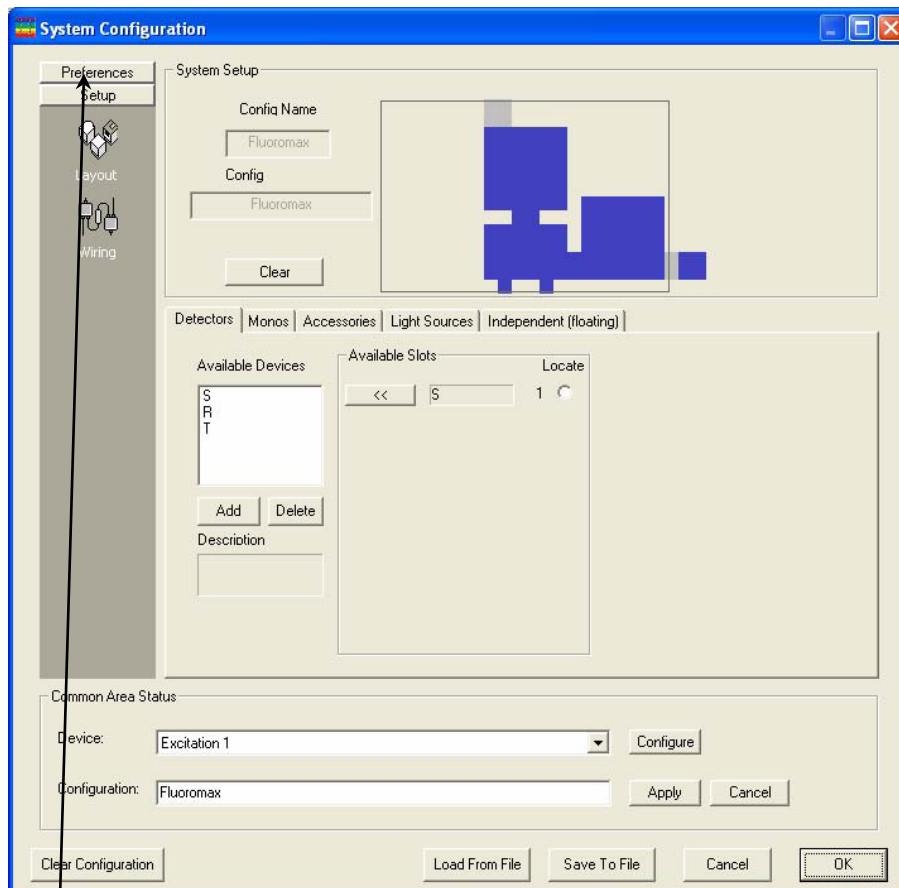
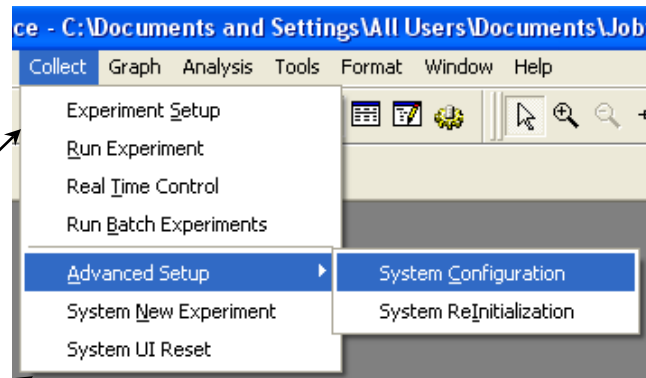



## 4 Choose Preferences.

The Preferences area appears.

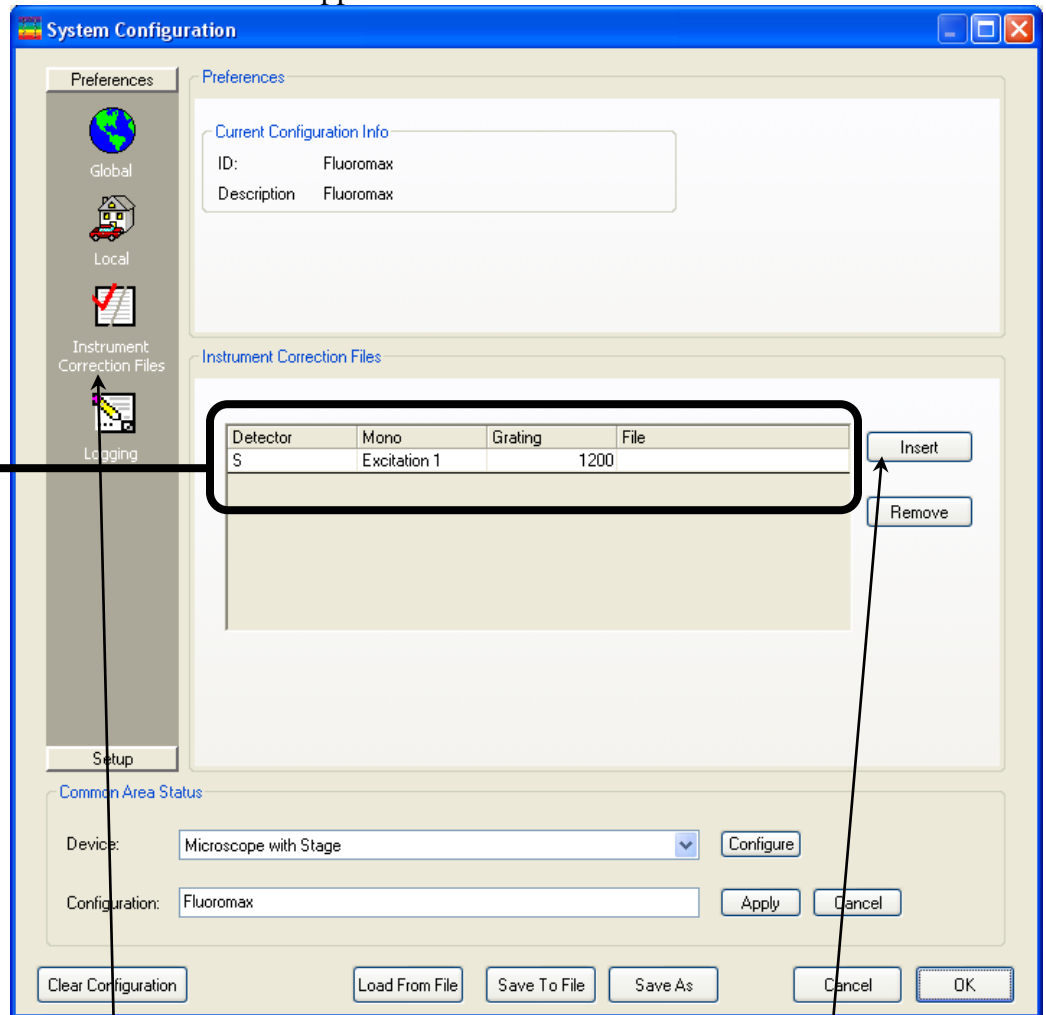

## 5 Choose the Instrument Correction Files icon.

The Instrument Correction Files area appears.

## 6 If there are no active fields in the Instrument Correction Files area, click the Insert button.

## 7 In sequence,

- a Choose the **Detector** column, and select the appropriate detector from the drop-down list,
- b The **Mono** column, and the correct monochromator from the drop-down list,
- c The **Grating** column, the correct grating from the drop-down list,



**Note:** The signal detector, S, uses only the *mcorrect* file; the reference detector, R, uses only the *xcorrect* file.

- d Then, in the **File** column, browse for the appropriate correction-factor file.
- 8 When all necessary detectors have an associated correction-factor file, click the OK button.
- 9 Reinitialize the instrument and software.
  - a In the FluorEssence™ toolbar, choose **Collect**.
  - b In the drop-down menu, choose **Advanced Setup**.
  - c In the drop-down menu, choose **System Reinitialization**.

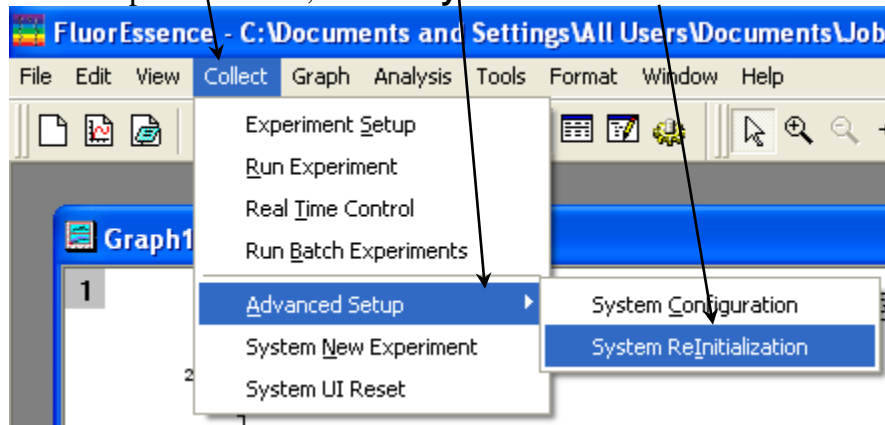

The new correction-factor files are now ready to be activated in the **Experiment Setup** window, under the **Detectors** icon:

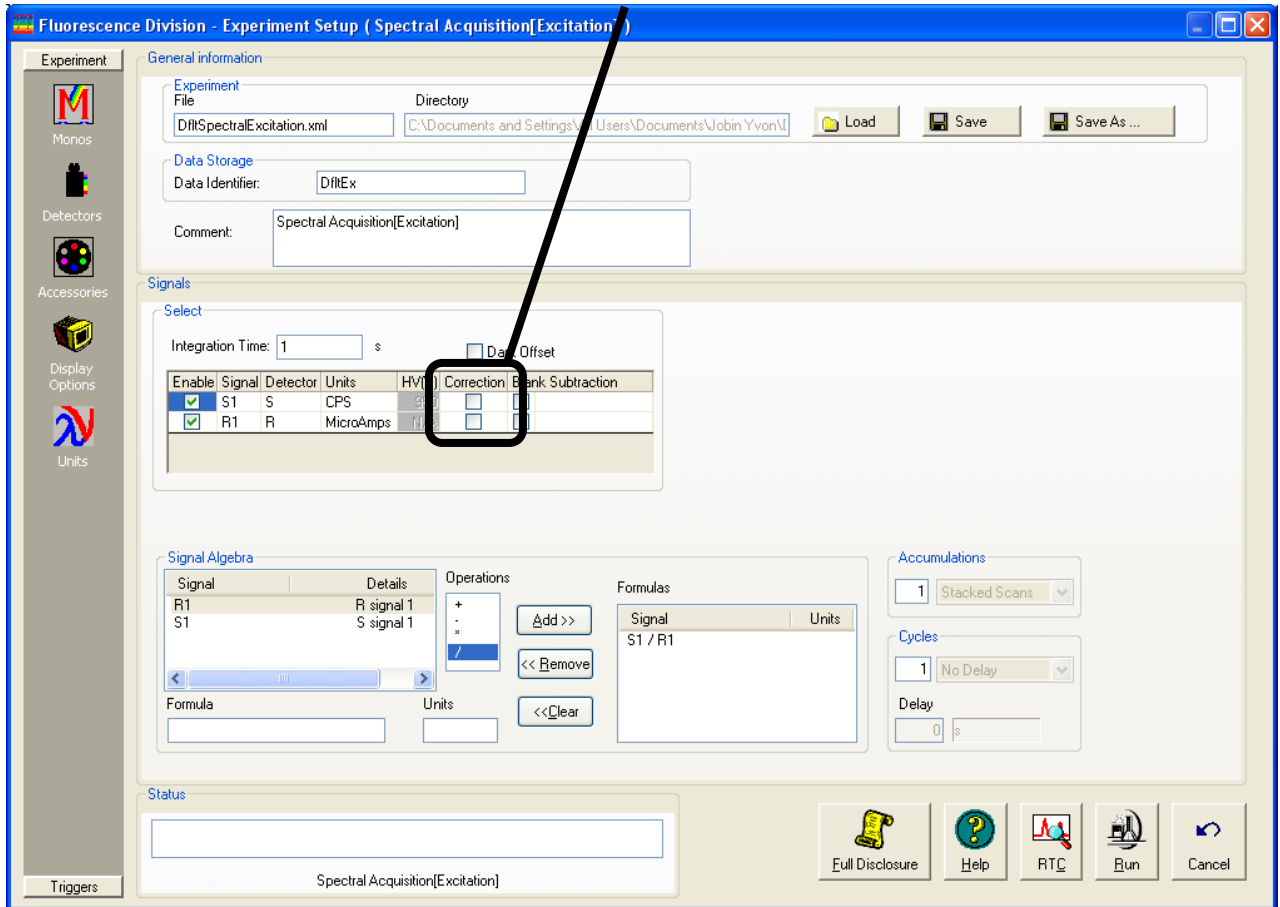

## Excitation correction factors

Excitation correction factors are measured during production of the instrument. If you have further questions, please contact the Service Department.



# 9 : FluoroMax<sup>®</sup> Plus Phosphorimeter Operation



## Introduction

The FluoroMax<sup>®</sup> Plus-P includes an optional phosphorimeter, that is, a programmable pulsed source and selectable signal gating from the reference detector. Switching between the pulsed lamp and continuous lamp is computer-controlled. Apart from this, the FluoroMax<sup>®</sup> Plus-P is identical in operation in all other respects to the FluoroMax<sup>®</sup> Plus.

# Theory of operation

A second source of illumination, a pulsed xenon lamp, is used for phosphorescence measurements. Samples are excited with pulsed light; the emitted phosphorescence is measured using an R928P photon-counting detector.

## Sequence of data acquisition

The illuminator housing, or flash lamp, operates at up to 25 Hz. The control module triggers each lamp pulse. When the start of the light output is detected, a signal is sent to the control module for timing purposes. The control module houses the signal-gating circuitry that intercepts the signal from the pulse-counting emission photomultiplier tube, collects a selected, time-delimited portion of the signal, and later passes it to the software. The maximum signal detectable per flash varies with the integration time:

Integration time	Maximum signal (counts) per flash
100 $\mu$ s	200
1 ms	2000
10 ms	20 000
100 ms	200 000
1 s	2 000 000

With, for example, the counts integrated over 10 ms, the maximum detectable signal is:

$$(1 \text{ second/integration time}) \times (\text{counts/flash}) = \text{total counts}$$

$$(1 \text{ second}/0.01 \text{ second}) \times (20\,000 \text{ counts/flash}) = 2\,000\,000 \text{ counts total}$$

A typical sequence of data-acquisition (see below) starts with a flash from the pulsed lamp, sensed by the control module as time  $t = 0$ . The light enters the excitation monochromator, where it is dispersed. Monochromatic light from the monochromator excites the sample. Luminescence emission from the sample then passes through the emission monochromator to the photomultiplier-tube detector. The control module includes a gate-and-delay generator, allowing the signal at the detector to be integrated only during a specific period after the flash (the Initial Delay), for a pre-determined length of sampling time (the Sample Window). Any signal arriving before or after the gating is ignored.

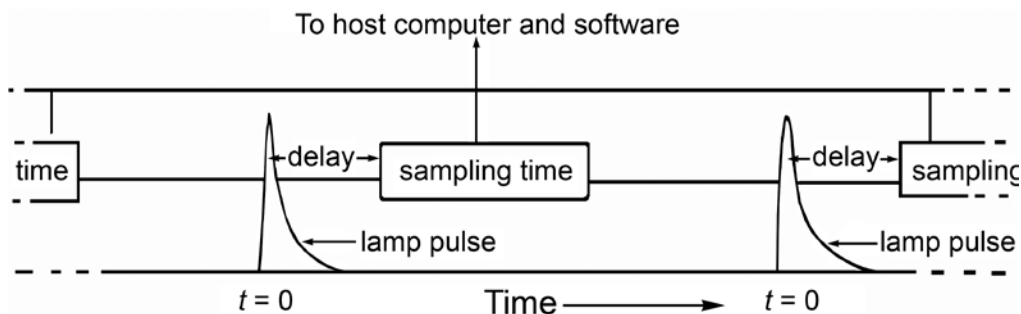

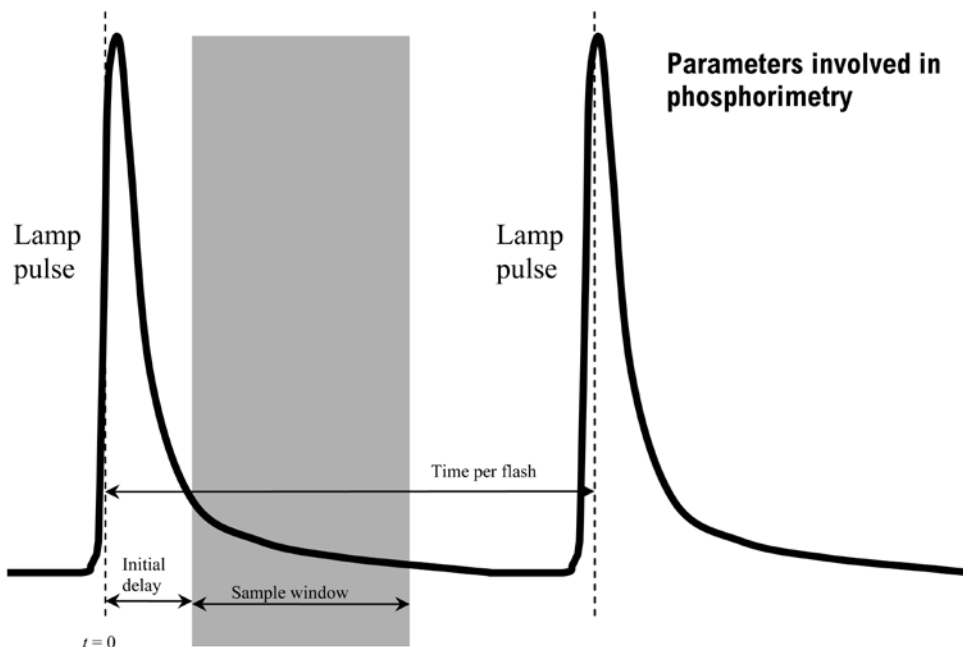

This sequence of excitation, delay, and sampling, is repeated for each lamp flash. The signal is accumulated for a predetermined number of excitation pulses, then FluorEssence<sup>™</sup> collects the total signal. After collection, FluorEssence<sup>™</sup> displays the intensity of the luminescence as a function of time or wavelength. The  $x$ -axis is based on one of the four scan options:

- Decay by Delay
- Decay by Window
- Emission
- Excitation

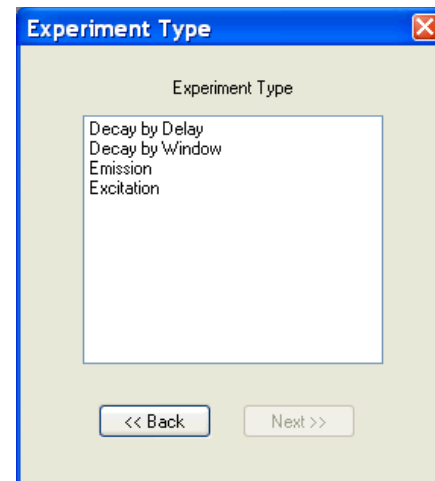

## Phosphorimeter parameters

Four FluorEssence<sup>™</sup> parameters govern the sequence in a phosphorimeter experiment. These parameters automatically appear on the phosphorimeter experiment-acquisition window.

**Initial Delay** Sets the time, in ms, between the start of the lamp flash and the onset of data-acquisition (opening of the Sample Window). Initial Delay can range from 0–10 000 ms, in increments of 0.001 ms. Accuracy of Initial Delay is better than  $\pm 0.001$  ms.

Set Initial Delay long enough so that fluorescence emission and lamp decay are complete, so that the resulting spectrum represents phosphorescence only. The full-width at half-maximum lamp-pulse width is 3  $\mu$ s, but there is a long decay time for the light output. Lamp intensity falls to less than 1% of peak output after 45  $\mu$ s. Setting the delay to  $> 50$   $\mu$ s effectively removes any interference from the lamp.

**Initial Delay** can be varied with time to yield a decay curve. Spectra can be scanned to isolate different phosphorescing components based on the lifetime of the luminescent species in the sample. Together, these two techniques can be used to create three-dimensional plots. For example, successive scans with varying delay times can be plotted.

To record fluorescence and phosphorescence emission, set **Initial Delay** to zero.

**Sample Window** Sets the duration of signal acquisition, in ms. The **Sample Window** opens when the **Initial Delay** ends. When the **Sample Window** opens, the signal is counted and integrated. After the **Sample Window** closes, any signal is ignored.

The **Sample Window** may be set from 0.01 to 10 000 ms. If the lifetime of the phosphorescence is known, set the **Sample Window** to 5–10 times the lifetime. If the phosphorescence lifetime is unknown, make the **Sample Window** a small fraction of the anticipated lifetime, and then increase it until acceptable results are observed.

If the **Sample Window** is too long, the detector will record spurious background signal. If the **Sample Window** is too short, components of the lifetime decay may be missed. With two or more species decaying simultaneously, try varying the **Initial Delay** and the **Sample Window**.

**Time per flash** Sets the total cycle length per flash, including on time, decay time, and dead time between flashes. The **Time per flash** is the reciprocal of the repetition rate of the lamp pulses. The allowable repetition rate is 0.03–25 Hz. The **Time per flash** must be slow enough to let the **Sample Window** close before another flash begins. Accuracy of the repetition rate is  $\pm 1$  ms.

In a Decay by Delay type of scan, the **Time per flash** is governed by

$$\text{Time per Flash} \geq \text{Maximum Delay} + \text{Sample Window} + 20 \text{ ms}$$

In a Decay by Window type of scan, the **Time per Flash** is governed by

$$\text{Time per Flash} \geq \text{Initial Delay} + \text{Maximum Sample Window} + 20 \text{ ms}$$

**Flash count** Sets the number of lamp pulses that contribute to each data point. The range for **Flash count** is 1 to 999. The signal collected per flash is integrated over the total **Flash counts** before FluorEssence<sup>™</sup> stores it. The more flashes accumulated, the higher the signal-to-noise ratio becomes.

For more information about FluorEssence<sup>™</sup> phosphorimeter commands, consult the FluorEssence<sup>™</sup> on-line help.



# Applications for the phosphorimeter

## Phosphorescence decay curve

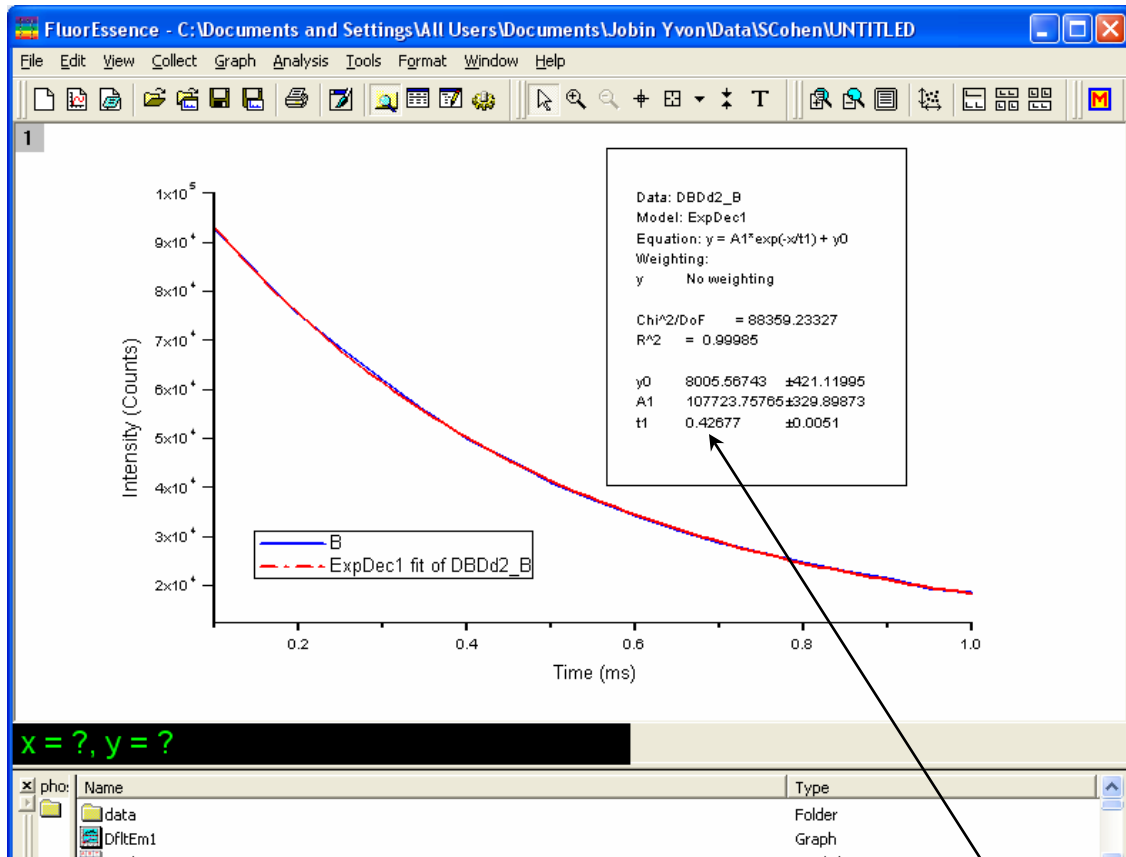

With the Phos experiment type in the **Fluorescence Experiment Menu**, create a phosphorescence-decay curve, as in the screenshot from FluorEssence<sup>™</sup> shown above. This is an example using data from  $TbCl_3(aq)$ , fitted to a single-exponential curve-fit in Origin<sup>®</sup>. All parameters are automatically displayed, including the fitted lifetime of 427  $\mu s$ .

## Isolate components in a mixture based on lifetimes

To the right are three scans of an aqueous mixture of terbium and europium chlorides that isolate different phosphorescent components based on their lifetimes. For example, a sample containing two phosphorescent species with different lifetimes (Tb = 421  $\mu$ s; Eu = 113  $\mu$ s) can be resolved into its components by varying the Initial Delay parameter, here shown as bold italic numerals, **0.1** ms, **1** ms, and **2** ms initial delay. Notice the wavelength shift in the 593 nm peak (marked with a gray line) from initially mostly europium fluorescence (short lifetime) to a mixture of terbium (longer lifetime) and europium fluorescence at later delays. Also notice the Eu peak near 690 nm at 0.1 ms that vanishes at later times. This experiment was performed using the Emission subtype of Phos experiment.

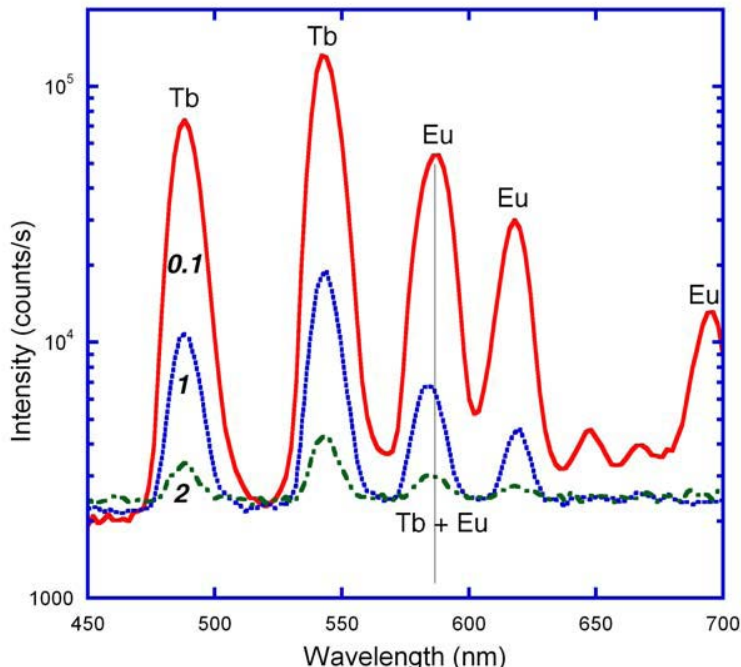

## Three-dimensional plots

Using the phosphorescence delay curve with the Initial Delay technique, a three-dimensional graph can be created, as shown below. This graph shows successive scans of a mixture of Tb-L and Eu-L (where L = benzophenone antenna chromophore) with varying time delays, segregating species into contours representing a particular slice of time.

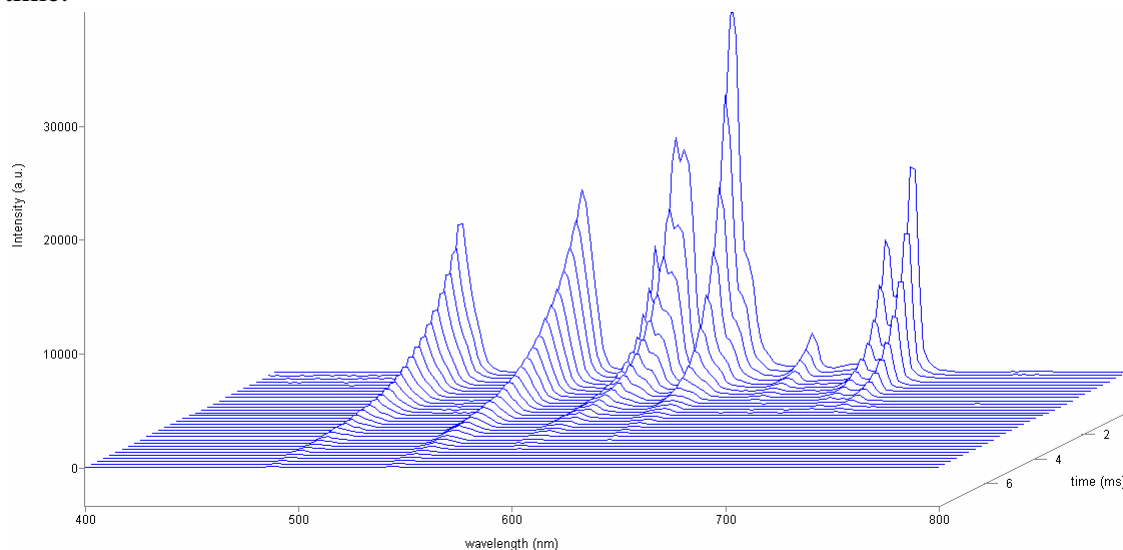

## Kinetic analysis of mixtures

Often a sample containing a mixture of components can be analyzed through fitting its phosphorescence-decay curve. Here is a phosphorescence decay of an aqueous mixture of  $\text{EuCl}_3$  and  $\text{TbCl}_3$ , whose different lifetimes have been extracted by FluorEssence™'s dual-exponential fit. Curve-fitting merely involves choosing the analytical model.

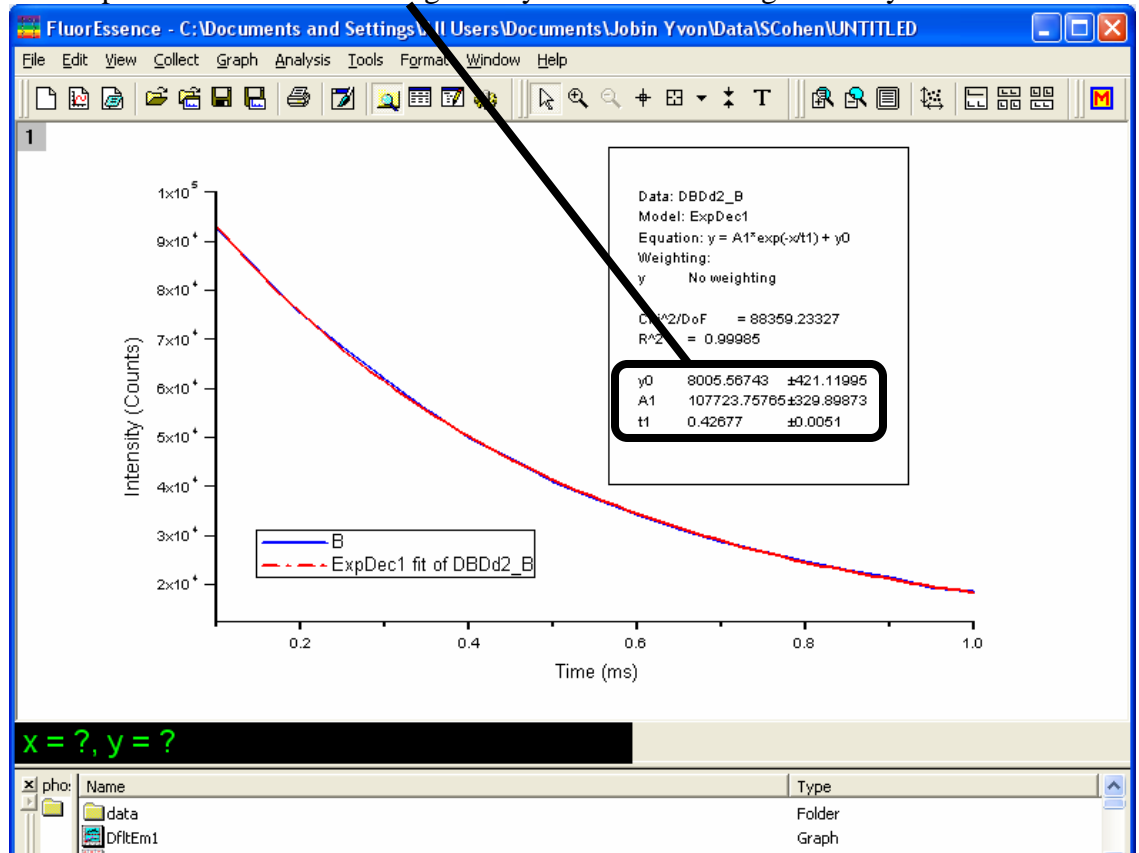

# Operation of the phosphorimeter

## Start-up

Load an appropriate instrument configuration that includes the phosphorimeter.

## FluorEssence™ features

### Main Experiment menu

This is where you choose to scan with the phosphorimeter, via a Phos scan:

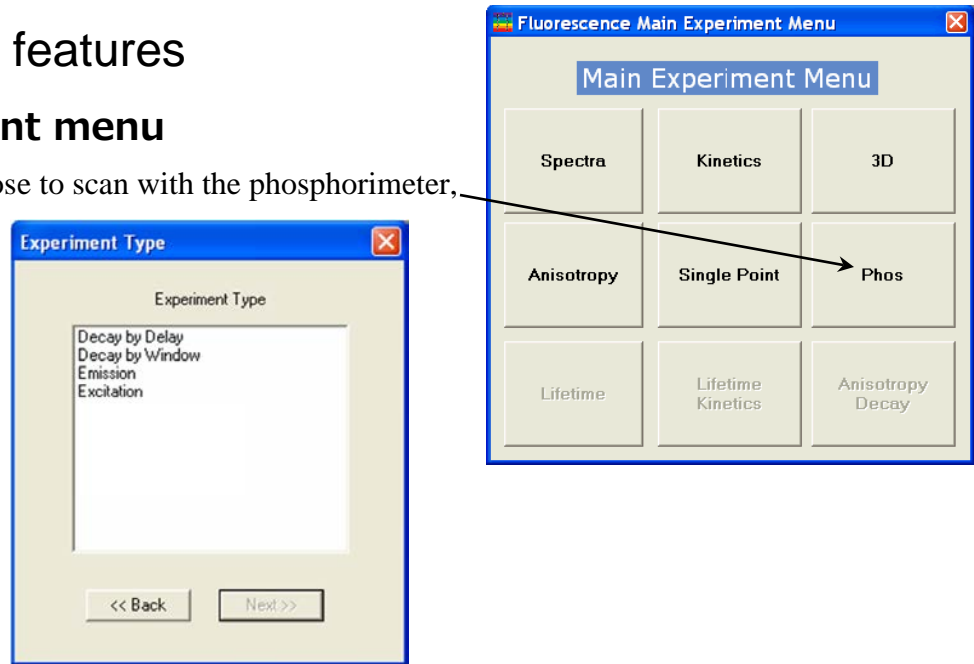

### Experiment Type window

After choosing the Phos experiment type in the **Fluorescence Main Experiment Menu**, four experiment types are available for the phosphorimeter in the **Experiment Type** window:

**Excitation** These are similar to the standard excitation, and emission scans. Among the changes are that the **Integration Time** field is removed, and instead are data-entry fields for **Sample window**, **Delay after flash**, **Time per flash**, and **Flash count**. These four fields are described above, in the Theory of Operation section, and shown below (extracted from the **Experiment Setup** window).

Phosphorimeter			
Time per flash	41	Time Units:	ms
Flash count	100		
Delay after flash	0.05	Sample window	0.1

Above is a Phosphorimeter area with a typical set of parameters for the emission of  $\text{EuCl}_3$ . Use an excitation monochromator set to 393 nm; the emission monochromator should start at 570 nm, end at 750 nm, with an increment of 1 nm.

**Decay by Delay**

These produce a decay of phosphorescence over time. Decay by Delay varies the Delay after flash in order to construct the decay curve:

**Decay by Window**

Phosphorimeter

Time per flash:  Time Units:

Flash count:

Initial delay:  Sample window:

Max delay:

Delay increment:

Decay by Window varies the length of the Window increment with constant Delay after flash while taking data, to construct the decay curve:

Phosphorimeter

Time per flash:  Time Units:

Flash count:

Delay after flash:  Initial window:

Max window:

Window increment:

Above is a Phosphorimeter area showing typical parameters for the phosphorimeter decay of EuCl3. Set the emission monochromator to 590 nm and the excitation monochromator to 393 nm.

**Experiment Setup window**

The **Experiment Setup** window, under the Detectors icon, includes a Phosphorimeter area, indicating that the phosphorimeter is available.

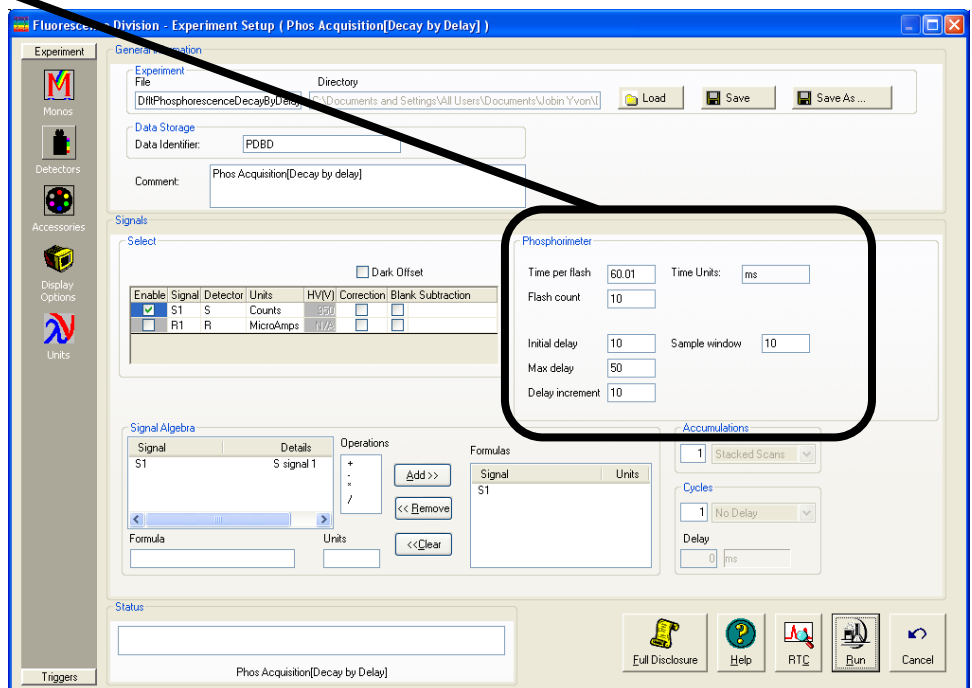

# Processing phosphorimeter data

- 1 Open the graph to be processed.
- 2 Click on the data points to be processed.

- 3 In the toolbar, choose Analysis.

A drop-down menu appears.

- 4 Choose Fit.

- 5 From the submenu, choose the type of analytical curve to use.

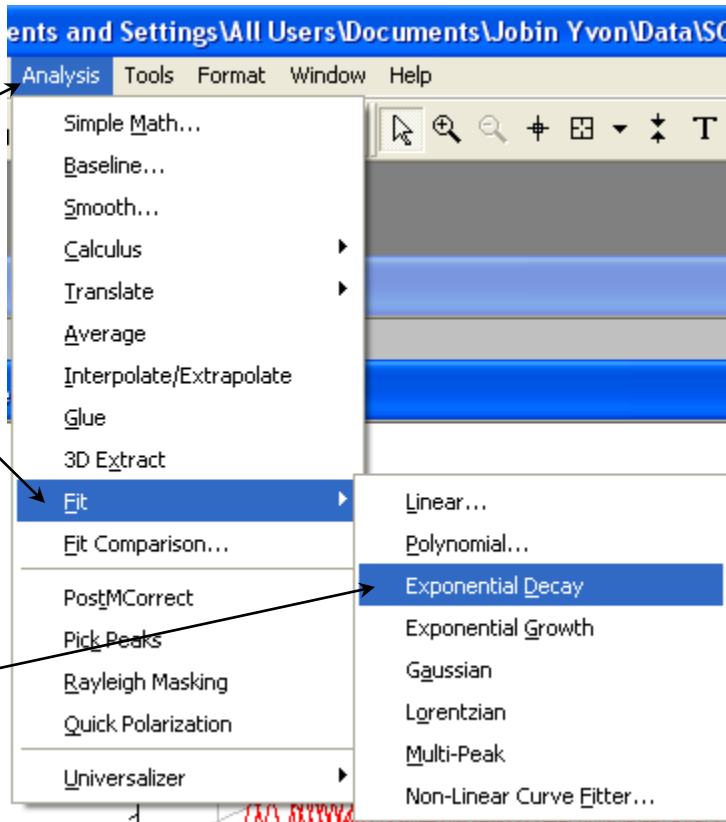

- 6 Follow the instructions for that type of curve.

The fit plus parameters appear on the graph.

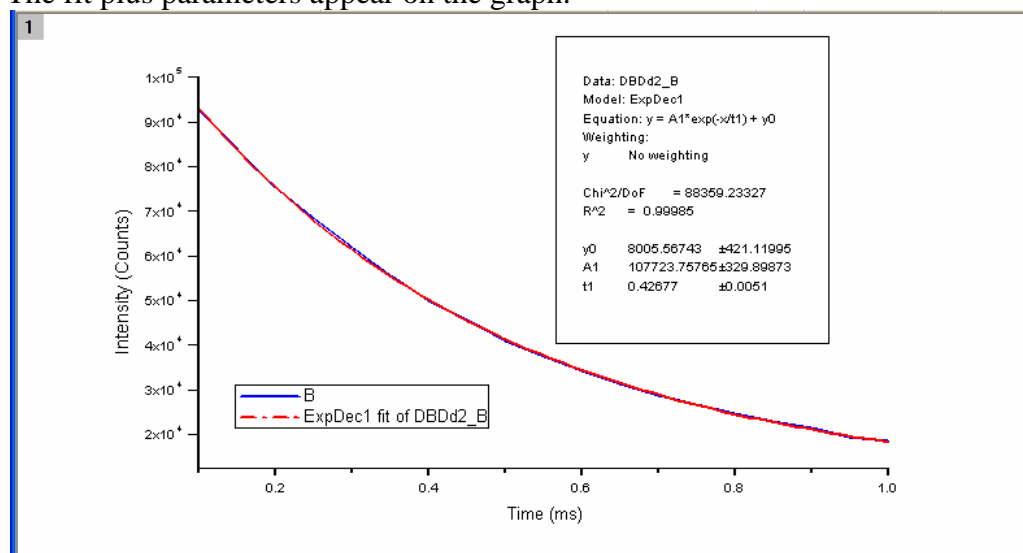

# Lamp replacement

The xenon flash lamp typically has a half-intensity life of at least 10 million flashes. Follow the procedure below for replacement and alignment.



**Warning:** High voltage exists within the FluoroMax<sup>®</sup> Plus-P. To avoid fatal shocks, before removing the lamp cover, unplug the FluoroMax<sup>®</sup> Plus-P's power cord, and wait at least 5 min while the internal capacitors discharge. **Never operate the lamp with the cover removed!**



**Caution:** Intense ultraviolet, visible, or infrared light may be present when the instrument is open, so wear eye- and skin-protection, such as light-blocking goggles and light-blocking clothing.



**Warning:** Xenon lamps are an explosion hazard. Be sure that the power is off, and all AC (mains) power is disconnected from the system. Read and follow all the cautions below:

## Hazards



- Xenon-arc lamps are an explosion hazard. Wear explosion-proof face-shield and protective clothing when opening the lamp housing and handling the lamp.
- Disconnect the lamp power supply from the AC power line (mains) while handling lamp leads. Lethal high voltages may exist.
- The lamp remains extremely hot for approximately one-half hour after it has been turned off. Do not touch the lamp or the metal unit until the lamp has cooled.
- Never look directly at the xenon arc or its reflection. Intense radiation can permanently damage eyes.
- Do not touch the focusing lens, back-scatter mirror, or the surface of the lamp. Fingerprints will be burned onto these surfaces when the lamp is ignited.

## Method

- 1 In FluorEssence™, be sure the FluoroMax<sup>®</sup> Plus-P instrument configuration is loaded.

The flip-mirror automatically rotates to the flash lamp, giving you more room to work.



**Caution:** Never rotate the flip mirror inside the lamp housing manually. This can strip the gears in the gearbox.

- 2 Switch off and prepare the FluoroMax<sup>®</sup> Plus-P.



- a Be sure that the FluoroMax<sup>®</sup> Plus-P and the host computer are turned off.
- b Remove the AC (mains) power cord from the FluoroMax<sup>®</sup> Plus-P.
- c Disconnect the RS-232 cable, power cord, and any other cables attached to the spectrofluorometer.

### 3 Gently remove the sample mount from the front of the FluoroMax<sup>®</sup> Plus-P.

The standard FluoroMax<sup>®</sup> Plus-P front is held via a friction fit, with no screws to remove. Some accessories require removal of 4 screws. Some sample mounts also have a 15-pin connector at the inside end for automated accessories.



### 4 Remove the lamp cover.

- a With an Allen key, remove the five screws from inside the left wall of the sample compartment.

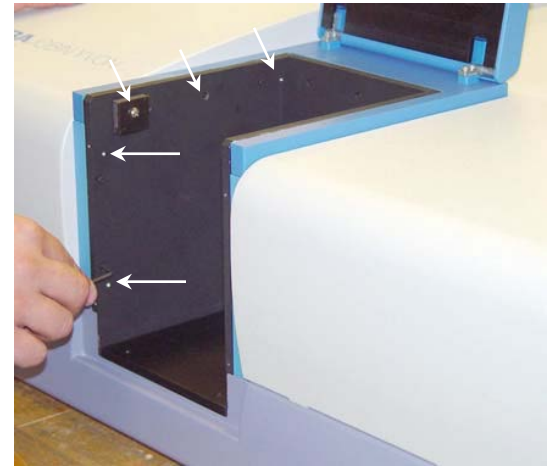

- b Pull the lamp cover to the left about 2 cm.

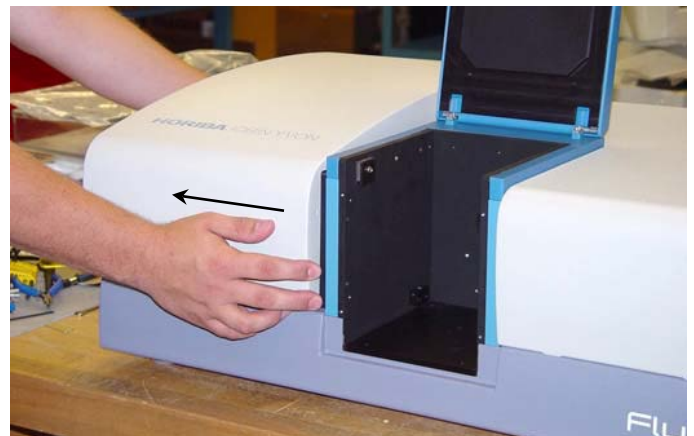

- C Lift the cover vertically off the instrument.

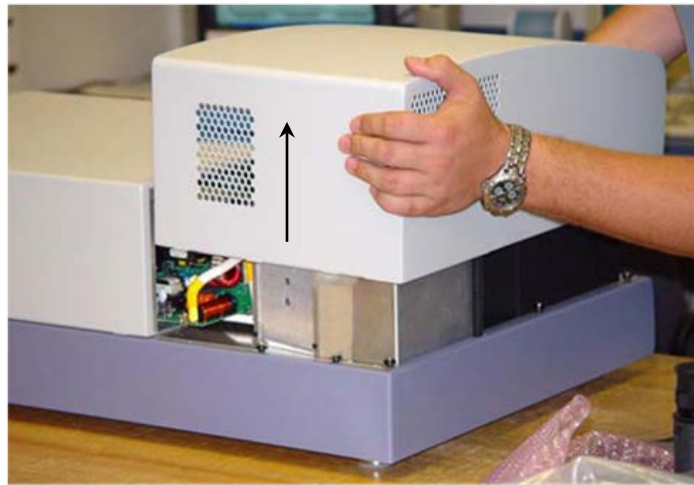

## 5 Remove the lamp-housing cover at the rear of the instrument.

- a With a Phillips screwdriver, loosen the safety cover's screw.



- b Swing the safety cover out of the way.

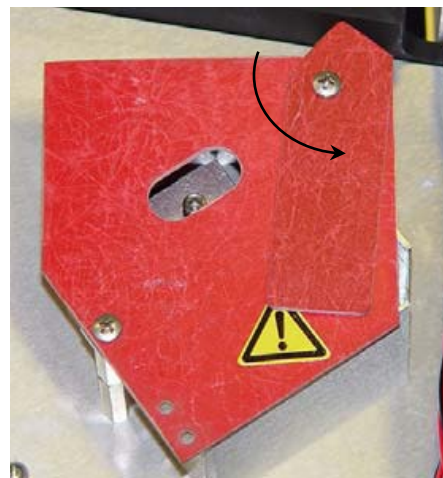

- C** Remove the three Phillips screws from the lamp-housing cover.

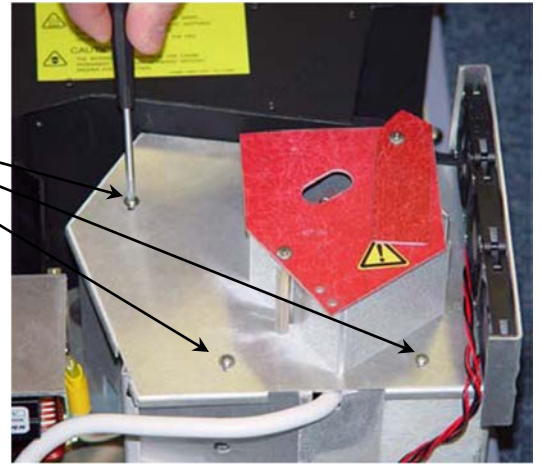

- d** Gently rotate the lamp-housing cover with its cooling fans attached.

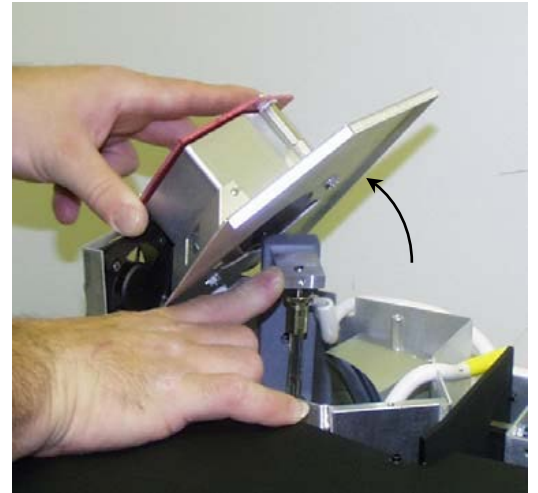

## 6 Remove the flash lamp.

- a** Follow all safety precautions on the new lamp's box.
- b** Pull the old flash lamp out with a steady motion.
- c** Discard the old flash lamp in a safe and appropriate manner.

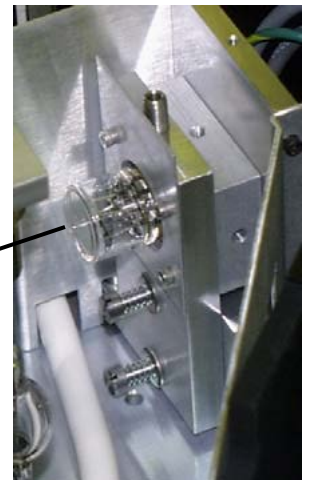

## 7 Insert the new flash lamp.



**Warning:** Never touch the flash lamp's glass bulb with bare hands. The oils from your hands can weaken the bulb and cause catastrophic failure. Handle the flash lamp with tissues, cloth gloves, or soft cloths only.

- a Align the pins with the lamp socket. The cathode and anode should be vertical, as shown → here.
- b Push the lamp in firmly until it is seated securely and properly.

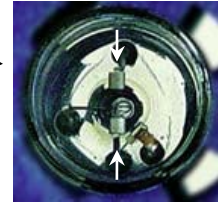

**Note:** If the lamp tilts during insertion, check the pins—they should be straight. If they are not straight, re-align the pins before insertion.

- 8 Replace the safety cover and lamp-housing cover.
- 9 Secure the three screws on the lamp-housing cover.
- 10 Replace the instrument cover, and reseal the five screws.
- 11 Reconnect all cables (power, accessories, etc.) to the FluoroMax<sup>®</sup> Plus-P.

# 10: Automated Polarizers

## Introduction

### Theory

The measurement of polarized emission of fluorescence allows the observation of rotational motions in fluorophores during the lifetime of the excited state. Because the rotation of macromolecules depends on their size, shape, and local environment (i.e., solvent), several kinds of information may be extracted. Polarized-emission measurements often are used to detect small changes in molecular size (*viz.*, aggregation, binding, cleavage) as well as environmental changes (local viscosity, membrane microheterogeneity, and phase transitions).

The first step in these measurements is the *excitation* of a selected group of fluorophores, a fraction of the total ensemble of molecules. This process is known as photoselection. Vertically polarized light typically is used to excite a population of molecules whose absorption dipole is oriented in the vertical direction. For photoselection, vertically polarized exciting light usually is produced using a polarizer in the excitation path. A laser whose emission is V-oriented also may be used.

The second step is molecular *rotation*. The molecule, once excited, may rotate during the lifetime of the excited state, typically  $\sim 10^{-9}$  s. Such rotation will depolarize the fluorescence emission. Measurement of the polarized emission components allows calculation of the type and extent of rotational motions of the molecule.

The third step is measurement of *emission*. The polarized components of fluorescence emission are measured using polarizer(s) in the emission path(s). Measurements of polarization or anisotropy are derived from the intensities of the vertically and horizontally polarized components of the fluorescence emission.

The last step is *calculation*. From the magnitude of the V and H emission components, the extent and type of rotational behavior may be calculated. Both polarization and anisotropy are used to express the rotational behavior. Polarization is a ratio, defined as the linearly polarized component's intensity divided by the natural-light component's intensity. Anisotropy is also a ratio, defined as the linearly polarized component's intensity divided by the total light intensity. Anisotropy is the preferred expression, because it is additive. Polarization is not additive, but often appears in earlier literature. The measurement is performed in exactly the same manner, differing only in the calculations.

Ideally, polarization ( $P$ ) and anisotropy ( $\langle r \rangle$ ) are measured using only the vertically polarized excitation with the horizontal and vertical emission components. These measurements are designated  $I_{VV}$  and  $I_{VH}$ , respectively, where the first subscript indicates the position of the excitation polarizer, and the second, the emission polarizer. Vertically ori-

ented polarizers (V) are said to be at 0° with respect to normal, and horizontally oriented polarizers (H) are said to be at 90°. Polarization and anisotropy are expressed as follows:

$$P = \frac{I_{VV} - I_{VH}}{I_{VV} + I_{VH}} \quad (1)$$

$$\langle r \rangle = \frac{I_{VV} - I_{VH}}{I_{VV} + 2I_{VH}} \quad (2)$$

In a real optical system, the  $G$ , or grating factor, must be included to correct for the wavelength response to polarization of the emission optics and detectors. The  $G$  factor is defined as:

$$G = G(\lambda_{EM}) = \frac{I_{HV}}{I_{HH}} \quad (3)$$



**Note:** In some literature, the  $G$  factor is defined as the **inverse** of Equation 3. Therefore, some equations derived in this manual may differ from other sources.

The  $G$  factor is primarily a function of the wavelength of the emission monochromator. The spectral bandpass of the emission also affects  $G$ . Thus, a pre-calculated  $G$  factor can be applied to experiments in which instrumental factors (emission wavelength and emission bandpass) are kept constant throughout the entire experiment. In experiments where constant emission wavelength and bandpass is impractical, such as in emission anisotropy spectra, the  $G$  factor must be measured by recording  $I_{HH}$  and  $I_{HV}$  during the experiment at each emission wavelength.

Polarization in a spectrofluorometer is defined as:

$$P = \frac{I_{VV} - G * I_{VH}}{I_{VV} + G * I_{VH}} = \frac{\frac{I_{VV} * I_{HH} - 1}{I_{VH} * I_{HV}}}{\frac{I_{VV} * I_{HH} + 1}{I_{VH} * I_{HV}}} \quad (4)$$

Anisotropy in a spectrofluorometer is defined as:

$$\langle r \rangle = \frac{I_{VV} - G * I_{VH}}{I_{VV} + 2G * I_{VH}} = \frac{\frac{I_{VV} * I_{HH} - 1}{I_{VH} * I_{HV}}}{\frac{I_{VV} * I_{HH} + 2}{I_{VH} * I_{HV}}} \quad (5)$$

Polarization and anisotropy can be interconverted using these two equations:

$$P = \frac{3\langle r \rangle}{2 + r} \quad (6)$$

$$\langle r \rangle = \frac{2P}{3 - P} \quad (7)$$

For single-photon excitation, the allowed values for the emission anisotropy are governed by:

$$\langle r \rangle = 0.4 \langle P_2(\cos \alpha) \rangle \quad (8)$$

where  $P_2(x) = \frac{3x^2 - 1}{2}$  is the second Legendre polynomial, and  $\alpha$  is the angle between the molecule's absorption and emission dipoles. The angle  $\alpha$  may vary from 0 to 90°. Thus the allowed values for  $\langle r \rangle$  and  $P$  are:

Parameter	$\alpha = 0^\circ$	$\alpha = 90^\circ$
$P$	+0.5	-0.333
$\langle r \rangle$	+0.4	-0.2

Values of  $\langle r \rangle > 0.4$  indicate scattered light is present in the measurement of  $\langle r \rangle$ . Values of  $\langle r \rangle < 0.2$  indicate the rotation correlation time to be faster than the luminescence lifetime of the sample. If the sample is excited with depolarized light—a less common technique—the measured value of  $P$  ranges from  $-1/7$  to  $+1/3$  (and  $\langle r \rangle$  from  $-1/11$  to  $+1/4$ ). The individual intensity components ( $I_{HH}$ ,  $I_{HV}$ ,  $I_{VH}$ ,  $I_{VV}$ ) are also referred to as *raw polarization*.

Experimentalists often multiply polarization units by 1000 to yield *millipolarization units*,  $mP$ , for very small changes in the polarization.

## Polarization geometries

Polarization measurements are taken in two basic geometries:

- L-format uses two polarizers, which are both rotated between horizontal and vertical positions for measurements. If the  $G$  factor is determined beforehand, only two measurements are required: the VV and VH components, found by rotating only the emission polarizer. The FluoroMax<sup>®</sup> Plus uses the L-format geometry.
- T-format uses one excitation and two emission polarizers. The excitation polarizer is rotated between horizontal and vertical for measurements, while the emission polarizers are fixed—one horizontal and the other vertical. If the  $G$  factor is determined beforehand, it is possible to obtain the anisotropy or polarization in one measurement cycle, for the VV and VH components are available simultaneously on the two emission detectors. The  $G$  factor is measured differently in the T-format technique.

A schematic diagram of the L-format geometry is shown on the next page:

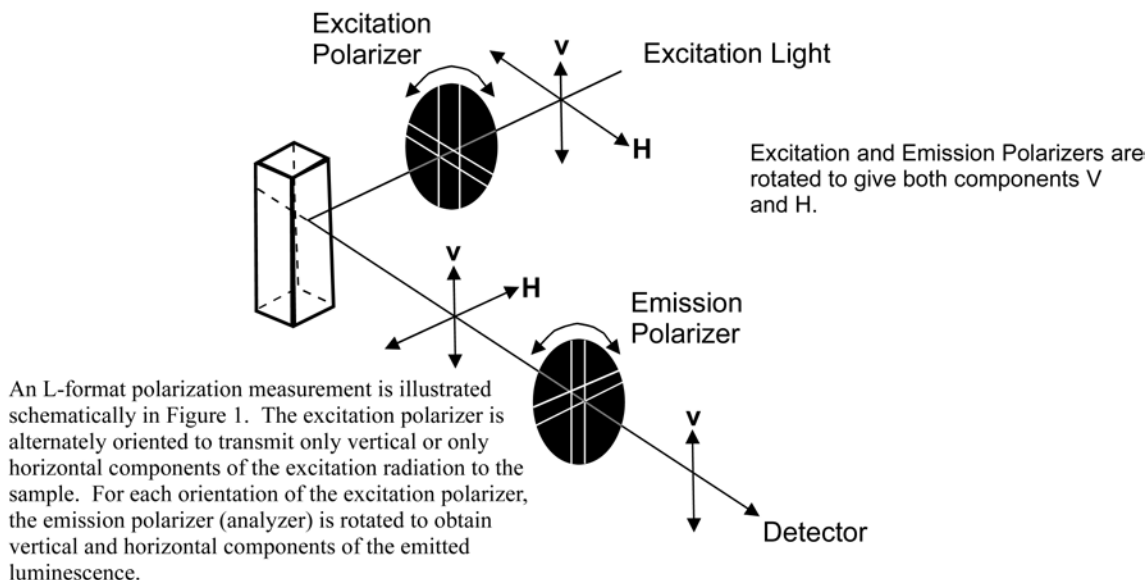

## Magic-angle conditions

Some fluorescent compounds exhibit molecular rotations on the same time-scale as their fluorescent lifetimes. This can cause a spectral distortion if the excitation and emission channels of a spectrofluorometer show some polarization bias. Specifically, when the rotational correlation time of a fluorophore is similar to the fluorescence lifetime, the effect can be significant. To record spectra that are free of rotational artifacts, use polarized photoselection conditions that cause the anisotropy to be zero. These polarization angles are called *magic-angle conditions*.

The two magic-angle conditions are:

- Use a single polarizer oriented at  $35^\circ$  in the excitation path with a scrambler plate, or
- Use two polarizers, with excitation at  $0^\circ$  and emission at  $55^\circ$ .

We recommend using the two-polarizer method, exciting with vertically polarized light, and measuring spectra with the emission polarizer set to  $55^\circ$ . Scrambler plates do not offer complete depolarization of the light beam at all wavelengths, and thus are not suitable for all experiments.

To use magic-angle conditions during data collection, set the excitation polarizers to V ( $0^\circ$ ), and the emission polarizer to magic-angle V ( $55^\circ$ ) using the **Accessories** icon in the **Experiment Setup** window. Collect spectra in the normal manner. To use magic-angle conditions for corrected spectra, measure an additional set of correction factors with the polarizers held at the chosen magic-angle settings.



**Note:** The majority of samples do not exhibit an appreciable change in their spectrum when they are measured under magic-angle conditions. Thus, magic angles need not be used for most samples.



# Installation

HORIBA Scientific's polarizers are pre-installed in the FluoroMax<sup>®</sup> Plus spectrofluorometer, if ordered as an option. New instrument and complete-polarizer orders are shipped with pre-aligned polarizers marked for excitation ("X") or emission ("M"), and are locked in their collars.



**Caution:** *When the polarizers are shipped inside an instrument, the polarizers are aligned and calibrated at the factory. Do not remove polarizers from their collars, or else the polarizer must be realigned.*

Proceed to "Alignment" in this chapter to verify alignment of the polarizers.

# Alignment

## Introduction

Polarizer alignment is verified by measuring the anisotropy of a dilute scattering solution. Scattered light is highly polarized, and this allows a simple check of the crystal alignment in the instrument. We recommend using a very dilute solution of glycogen or Ludox<sup>®</sup> (colloidal silica) as the scattering sample. The Ludox<sup>®</sup> we use as the reference is Aldrich 420859-1L, Ludox<sup>®</sup> TMA Colloidal Silica, 34 wt. % suspension in water, de-ionized.



**Caution:** Refer to your Material Safety Data Sheets (MSDS) for hazards regarding the use of glycogen, colloidal silica, or other scatterers.

The alignment test may be a measurement of the polarization or anisotropy within the software using the **Anisotropy** scan-type, or use of the **Remeasure Anisotropy Only** utility (click **Advanced...**, and the **Polarizer Alignment** window opens). The test also may be performed manually using the **Real Time Control** application. One measures the polarization, anisotropy, or the polarization ratio of scattered light (typically, the excitation and emission monochromators are both set to 370 nm for the measurement). To calculate the *polarization ratio*, use the definition:

$$\text{polarization ratio} = \frac{I_{VV} * I_{HH}}{I_{VH} * I_{HV}} \quad (9)$$

Alignment is satisfactory when the polarization ratio  $\geq 100$ , or  $P \geq 0.98$ , or  $\langle r \rangle \geq 0.97$ .



**Note:** The polarization ratio can be lowered by using concentrated scatterer. Use only a **slight** amount of scatterer to align the system.

The check below assumes a sample of Ludox<sup>®</sup> or glycogen is used.

## Method

- 1 Start FluorEssence™.
- 2 Open the Experiment Setup window.

You may use any instrument configuration with polarizers.

- 3 Click the Accessories icon.

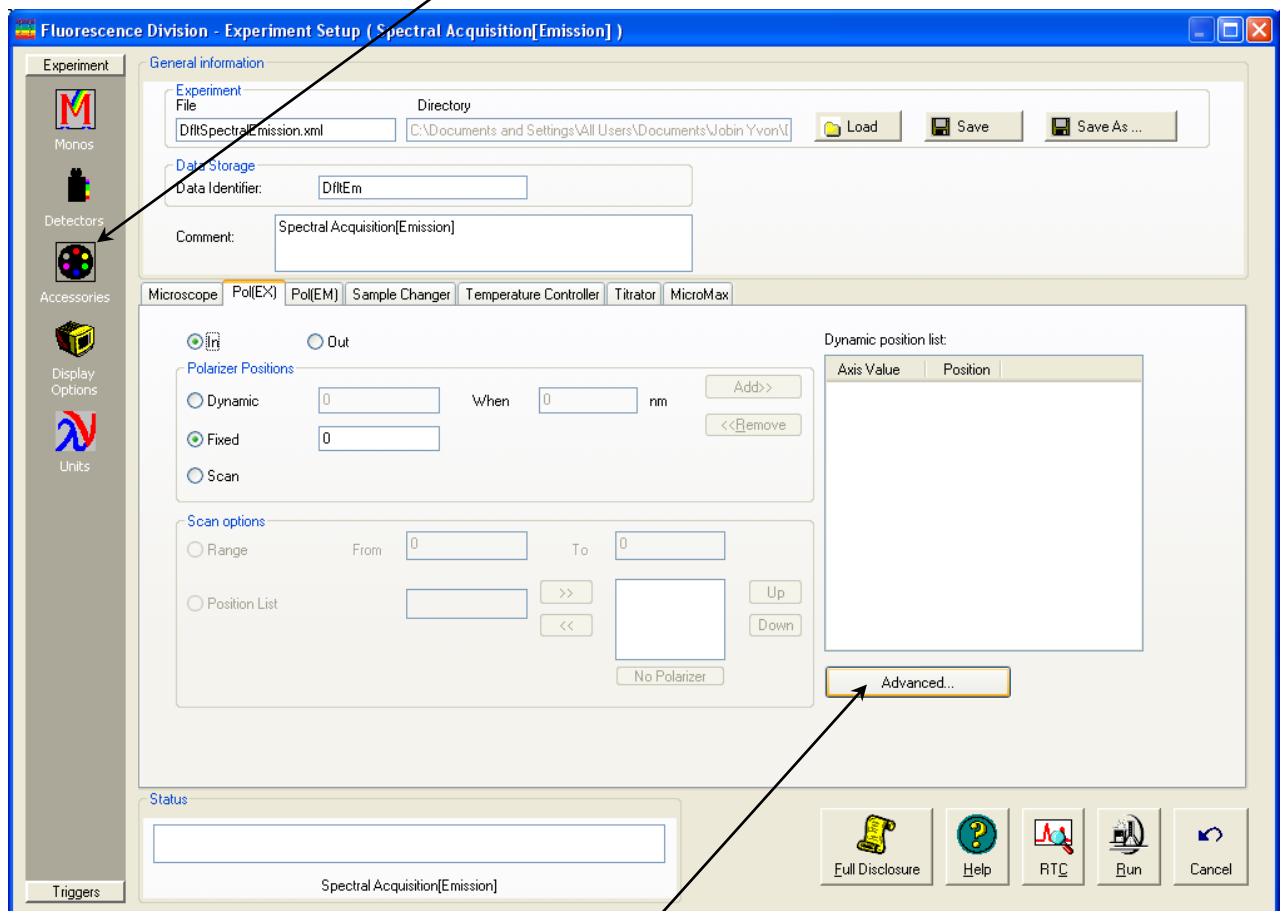

- 4 Click the Advanced... button.

This opens the **Polarizer Alignment** window:

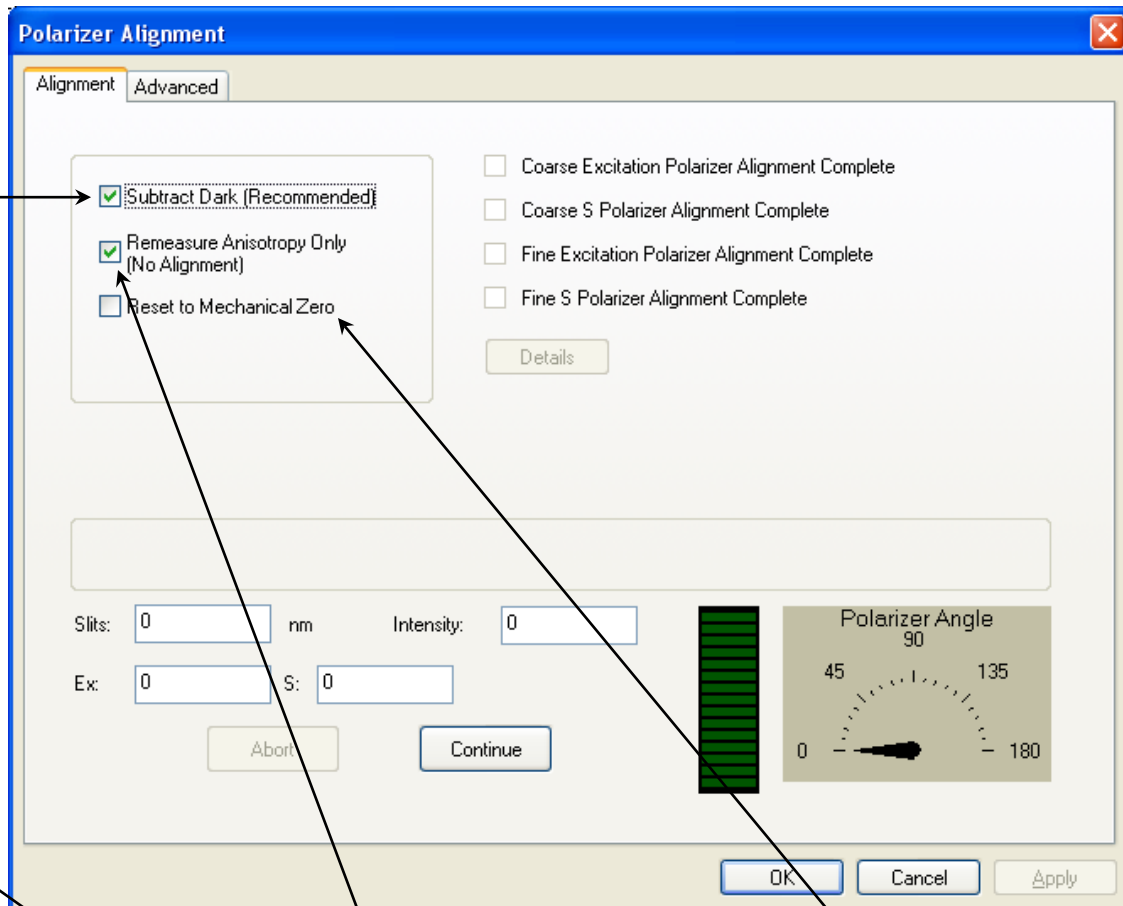

- Activate the **Subtract Dark** checkbox.
- Activate the **Remeasure Anisotropy Only** checkbox.
- Activate **Reset to Mechanical Zero** only if the polarizers are definitely miscalibrated. This deletes the previous calibration.

5 Place the Ludox® or glycogen in the sample holder.

6 Click the Continue button.



**Caution:** Refer to your Material Safety Data Sheets (MSDS) for hazards regarding the use of glycogen or colloids.

The system rotates through the polarizers as shown in the checklist on the window. As each phase is completed, the checkboxes are updated. If the sample is too concentrated or dilute, the software prompts you to correct this.

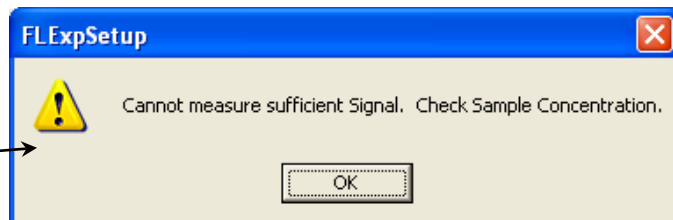

When complete, the software displays the measured anisotropy for the emission channel (S).

- 7 Approve or retry the measurement based on satisfaction with the result.
- 8 To quit, hit the Cancel button at any time during the procedure.

As an alternative, use an Anisotropy scan to acquire the polarization ( $P$ ) or anisotropy ( $\langle r \rangle$ ) to verify alignment. To be aligned,  $P \geq 0.98$  or  $\langle r \rangle \geq 0.97$ .

## Re-alignment of polarizers

FluoroMax<sup>®</sup> Plus autopolarizers may be aligned using a software routine called **Polarizer Alignment** in **Experiment Setup**.



**Note:** *Polarizers are aligned at the factory, and should not need realign-*

## Using Polarizer Alignment

This routine automatically calibrates autopolarizers. Use a sample of Ludox<sup>®</sup> or glycogen to run the alignment routine. The software rotates the polarizers in 1° increments and locates the optimal positions for each autopolarizer. After completion, the anisotropy for the scattering solution is measured and displayed for user approval of the alignment. If approved, the new calibration positions are saved in the sample-compartment initialization file, and a log file, POLAR.LOG, is saved with the results of the calibration procedure. Otherwise, the previous calibration positions are still used.

- 1 Start FluorEssence™.
- 2 Open the Experiment Setup window.
- 3 Click the Accessories icon.

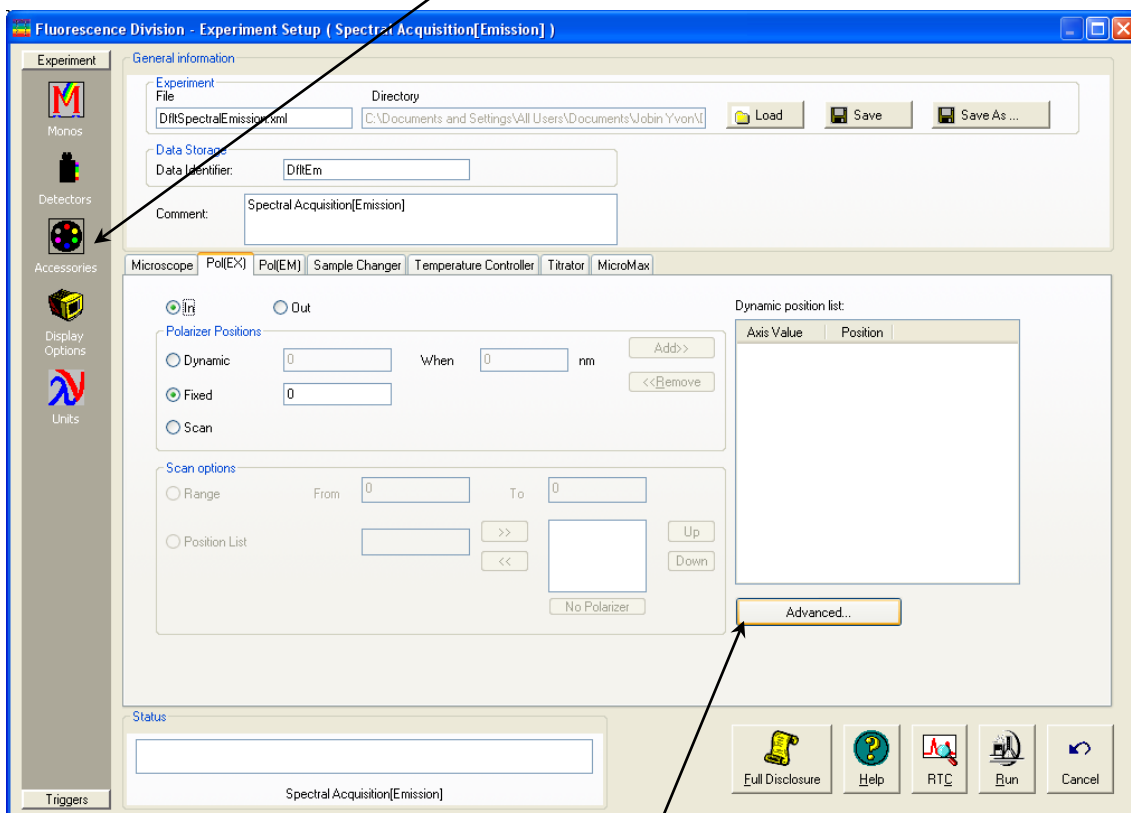

- 4 Click the Advanced... button.

This opens the **Polarizer Alignment** window:

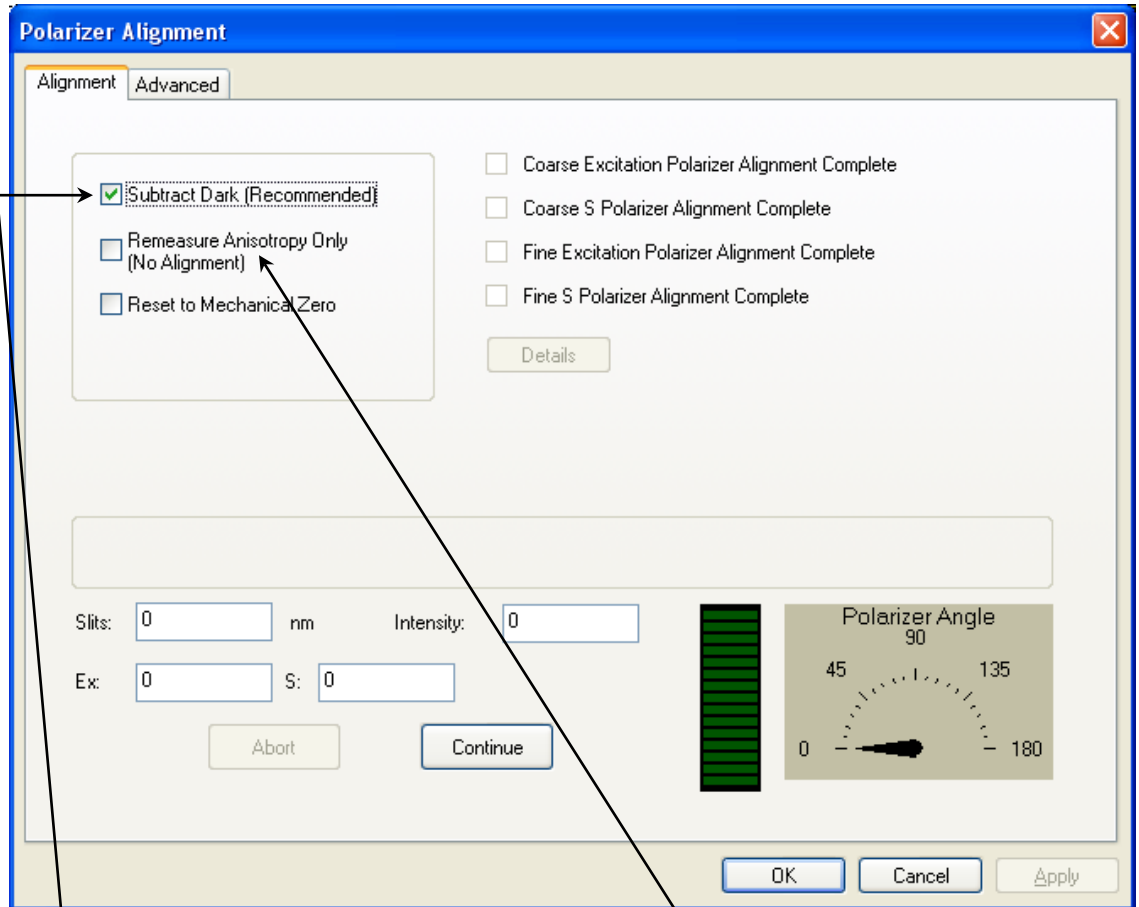

- Subtract Dark (recommended)
- Reset to Mechanical Zero—only if the polarizers are definitely miscalibrated. This deletes the previous calibration.



**Note:** Do not check the Remeasure Anisotropy Only checkbox.

5 Place the Ludox® or glycogen in the sample holder.



**Caution:** Refer to your Material Safety Data Sheets (MSDS) for hazards regarding the use of glycogen or colloidal silica.

6 Click the Continue button.

The system rotates through the polarizers as shown in the checklist on the window. As each phase is completed, the checkboxes are updated. If the sample is too concentrated or dilute, the software prompts you to correct

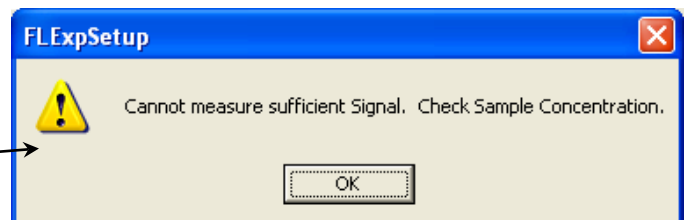

this.

When complete, the software routine displays the measured anisotropy for the emission channel (S).

**7 Approve or retry the measurement based on satisfaction with the result.**

Acceptable values are anisotropy  $\geq 0.97$  and polarization ratio  $\geq 100$ .

**8 To quit, hit the Cancel button at any time during the procedure.**



# Using automated polarizers

FluorEssence<sup>™</sup> software with HORIBA Scientific polarizers provides many choices for polarization measurements. Depending on the accessories, the opportunity exists to remove polarization effects from the sample, measure the polarization characteristics, or analyze the decay of anisotropy using frequency-domain techniques. For further software information, refer to the FluorEssence<sup>™</sup> and Origin<sup>®</sup> on-line help.

## Applications for polarizers

- Measurement of emission anisotropy or polarization at fixed wavelengths. This is used for binding assays, kinetics of molecular size- or shape-change, temperature effects on rotational motion of fluorophores (e.g., phase transition of phospholipid bilayers).
- Measurement of excitation and emission spectra using magic angles. This helps to eliminate spectral artifacts.
- Measurement of a principal polarization or excitation anisotropy spectrum, using an excitation scan with polarization. This provides information about rotational sensitivity of the excitation spectrum by measuring  $\langle r \rangle$  versus  $\lambda_{\text{exc}}$  (with  $\lambda_{\text{em}}$  constant). Examine relative molecular dipole-angles at cryogenic temperatures in a viscous solvent.

# Using FluorEssence™

To use the autopolarizers, load an instrument configuration with autopolarizers.

## Real Time Control

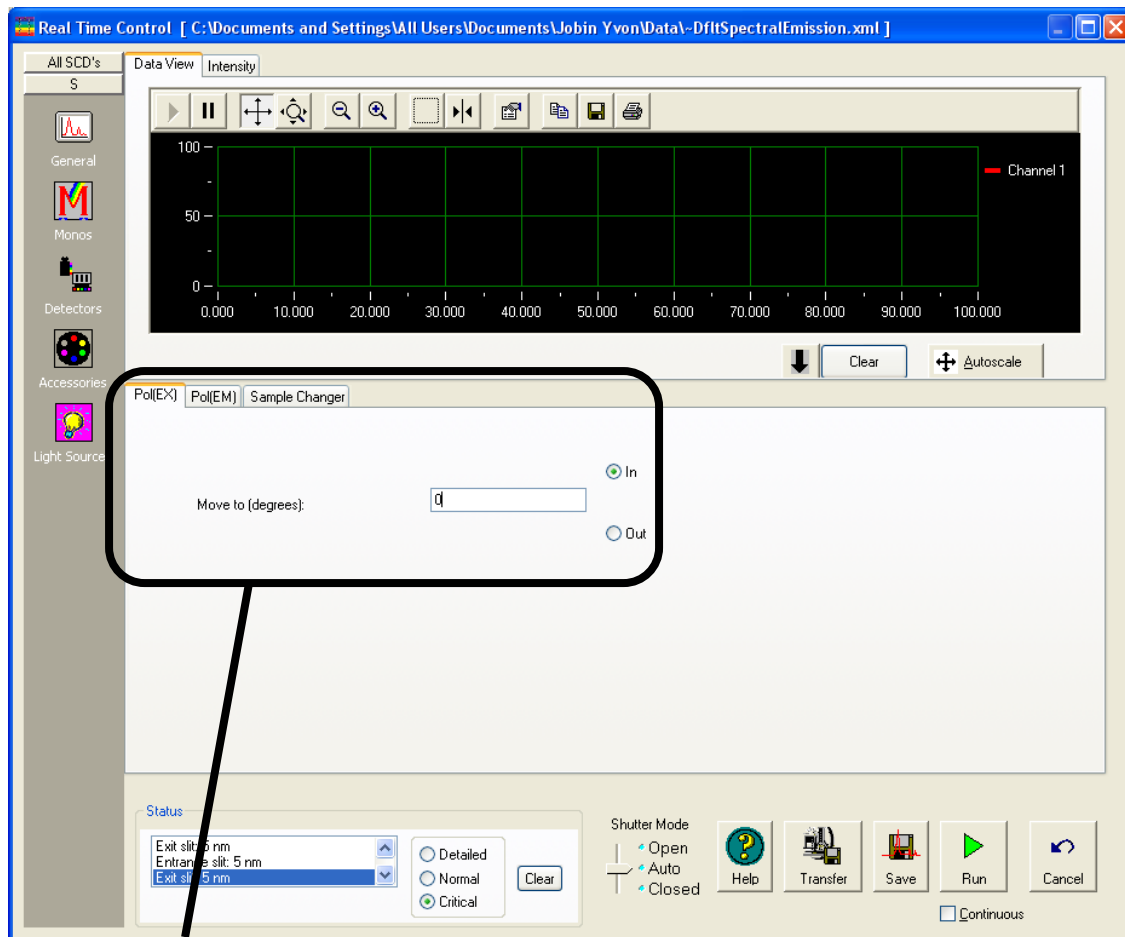

**Real Time Control** manipulates the polarizers and other instrument settings, to observe and optimize the spectrofluorometer in real time. Under the **Accessories** icon, each polarizer may be set independently into or out of the optical path under its own index-card tab. A custom angle may be set from 0–180°, in the field provided.



**Note:** *Real Time Control is only intended for real-time setup of a scan. Use Experiment Setup to work at fixed wavelengths.*

## Experiment Setup

**Experiment Setup** runs all scanning options for the autopolarizers. First choose the type of scan using polarizers in the **Fluorescence Main Experiment Menu**:

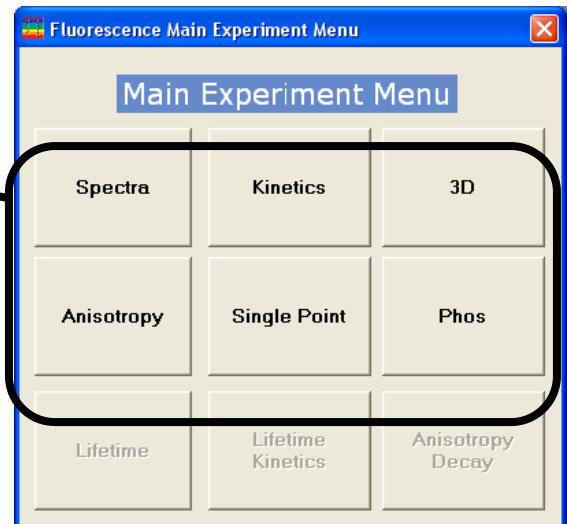

The **Experiment Setup** window appears.

Adjust polarizer parameters under the **Accessories** icon. One index-card tab appears for each polarizer.

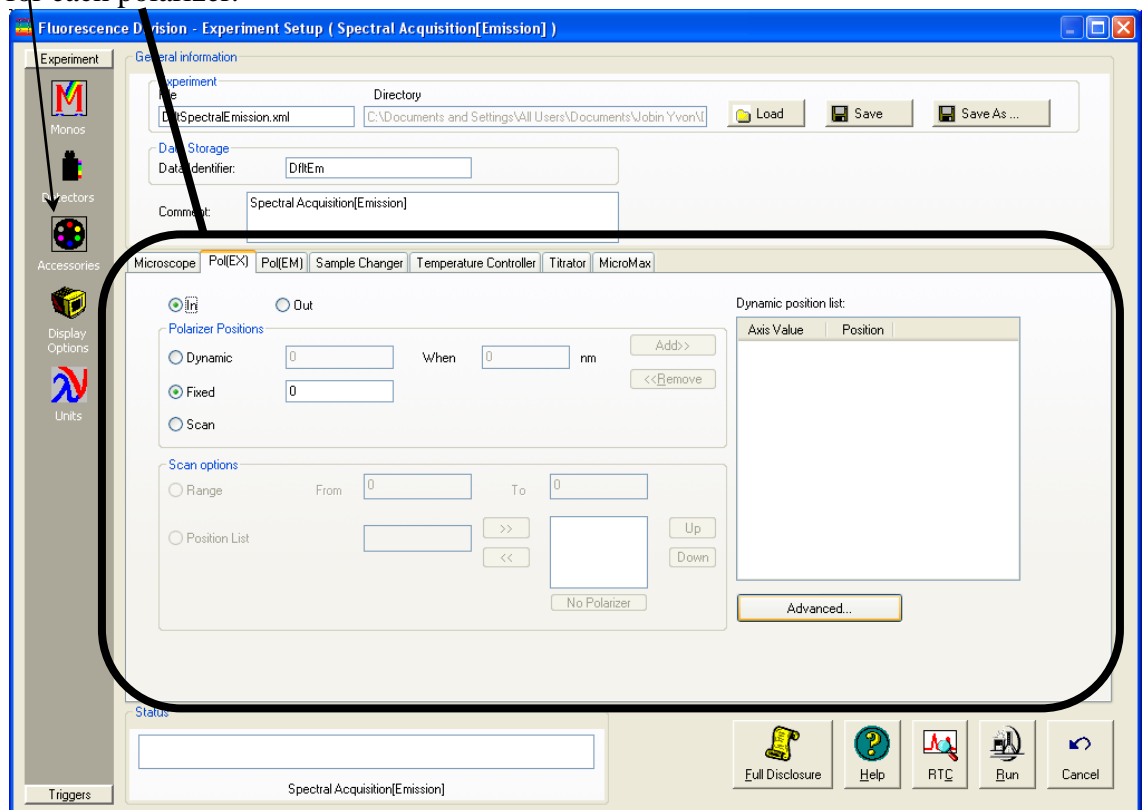

## Constant Wavelength Analysis

To do a constant-wavelength analysis experiment, that is, to take polarization acquisitions at fixed excitation/emission wavelength-pairs, choose **Anisotropy** from the **Fluorescence Main Experiment Menu**.

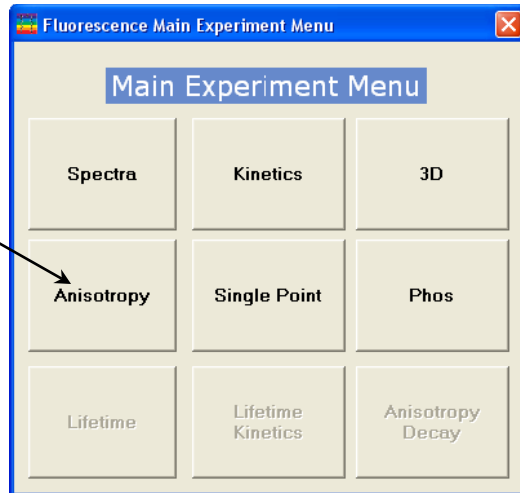

The **Experiment Type** window opens.

Choose **vs SinglePoint**, then click the **Next >>** button.

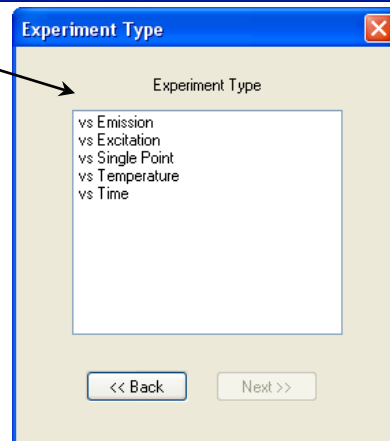

The **Experiment Setup** window appears.

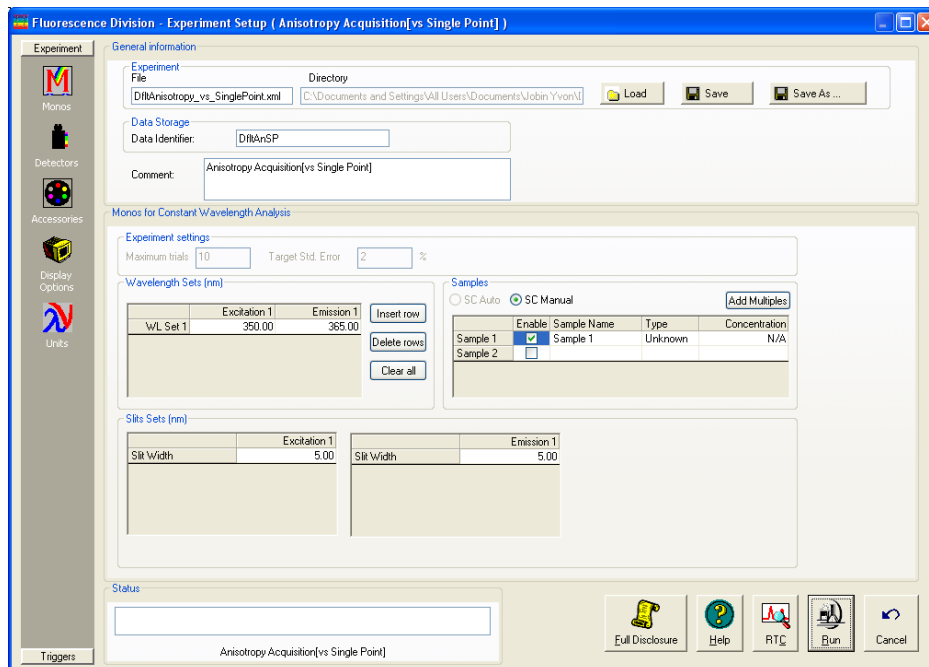

Make sure to use the appropriate Signal in the Signal Algebra area. Add >> it to the Formulas table. You can add the detector signals at any of five polarization-angle combinations (VV, VH, HV, HH, VM) to the Formulas list. The polarization and anisotropy ratios are calculated automatically in the Anisotropy-type experiments, and added by default to the Formulas list.

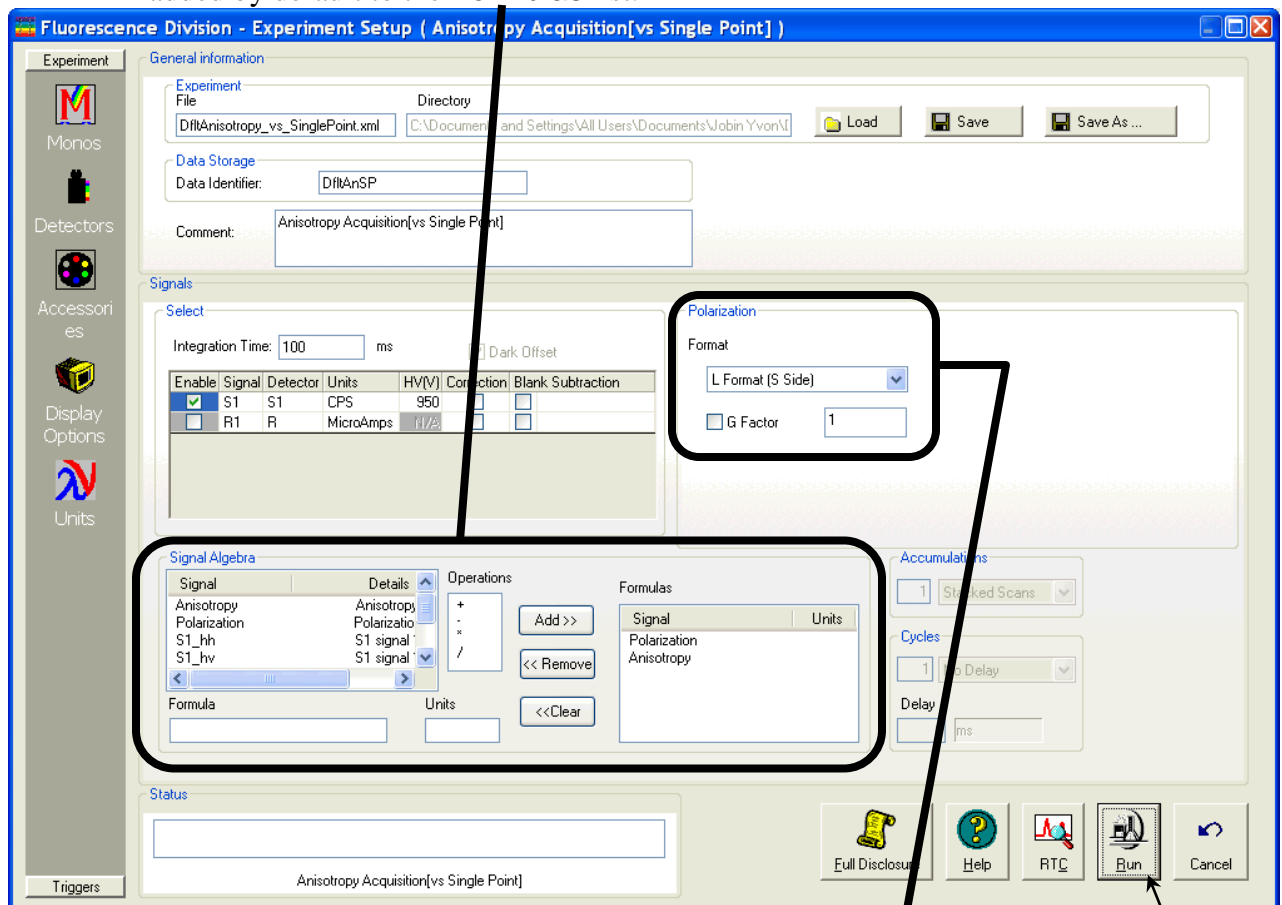

Click the **G** factor checkbox if you know the *G* factor, then enter the *G* factor in the box. If you do not know the *G* factor, leave the **G** factor checkbox unchecked, and enter 1. The *G* factor will be measured during the experiment, and automatically used in the anisotropy or polarization ratios.

Click the Run button when ready.

# Maintenance

Like all optics, polarizers should be handled with care and stored properly. With proper care, a polarizer should last for many years.

Should the polarizer windows need cleaning, apply a mild solution of methanol, and blow it dry.

We recommend measuring the anisotropy of scatter (to verify the alignment of the crystals) before any critical experiment. In addition to the standard xenon-lamp spectrum and water-Raman spectra, which serve to verify the wavelength calibration, measurement of the anisotropy of scatter will provide a fast check that the instrument system is ready to perform measurements. To do this anisotropy test, use a very dilute solution of scattering particles such as Ludox<sup>®</sup>, with a bandpass of 2–3 nm on both excitation and emission, to give a signal of  $1 \times 10^6$  counts per second with polarizers rotated to VV. Under these conditions, you should get a  $P \geq 0.985$ .



**Caution:** Refer to your Material Safety Data Sheets (MSDS) for hazards regarding the use of methanol and Ludox<sup>®</sup> or other scatterer.

# Troubleshooting

For difficulties with polarizers, consult the table below to see if your question is answered here. Otherwise, reach the Service Department at HORIBA Scientific by phone, fax, or e-mail. Before contacting us, please follow the instructions below:

- 1 Note the problem and record any error messages.**
- 2 See if the problem is listed on the following pages.**

If so, try the suggested solutions. Be sure to note carefully the steps taken to remedy the problem and the result. Refer to the appropriate section of this manual (and the software manuals, if necessary).

- 3 If the problem persists, or is not listed,**

Call the Service Department by phone at (732) 494-8660, or fax at (732) 494-8796. Outside the United States, call the local distributor. You may also reach us by e-mail at [scientificservice.us@horiba.com](mailto:scientificservice.us@horiba.com).

When you contact the Service Department, have the purchase date, serial number, system configuration, and software version available. Be prepared to describe the malfunction and the attempts, if any, to correct it. Note any error messages observed and have any relevant spectra (sample, polarization ratio, xenon-lamp scan, water-Raman scan) ready for us to assist you.

Problem	Cause	Possible Remedy
<b>Poor polarization data</b>	Improper sample concentration	Adjust sample concentration.
	Photomultiplier saturated; slits improperly set	Check that sample signals are in linear region ( $< 2 \times 10^6$ cps on S, $< 10 \mu\text{A}$ on R). Reset slits.
	Dirty cuvette	Clean the cuvette.
	Polarizer misaligned	Check polarizer alignment.
	Using plastic or cylindrical cuvette	Use rectangular, glass or quartz cuvette.
	System misaligned	Check system alignment in a generic layout. Run lamp scan and water-Raman scan to check calibration.
<b>Low polarization ratio</b>	Highly concentrated standard	Check Ludox <sup>®</sup> or glycogen concentration: higher concentrations can cause inner-filter effect, lowering ratio.
	Improperly set slits	Set slits for $\sim 1 \times 10^6$ cps in VV. Signals much less than this give excessive contribution from dark noise, while signals $> 2 \times 10^6$ cps are in non-linear region.
	System misaligned	Check system alignment in generic layout. Run lamp scan and water-Raman scan to check calibration.
<b>Autopolarizers do not initialize (they do not move during initialization).</b>	Wrong instrument configuration is loaded	Check that a configuration with autopolarizers is loaded.
<b>Software failure initializing autopolarizers</b>	Wrong instrument configuration is loaded	Check that a configuration with autopolarizers is loaded.
	Bad cable connections	With the system power off, recheck cable connections.
	Computer hang-up	Exit the software, and reboot the system and host computer.



# 11: Technical Specifications

## Introduction

Each FluoroMax<sup>®</sup> Plus system consists of:

- An excitation source
- An excitation monochromator
- A sampling module with reference detector
- An emission monochromator
- Two emission detectors.

Optional polarizers and phosphorimeter add

- A motorized mirror to change between light sources
- A pulsed xenon lamp
- A phosphorimeter-control module

Each system is controlled by an IBM-PC-compatible computer, and may include a printer for hard-copy documentation.

The details and specifications for each component of the FluoroMax<sup>®</sup> Plus spectrometer follow.

# Spectrofluorometer system

## FluoroMax<sup>®</sup> Plus

The FluoroMax<sup>®</sup> Plus spectrofluorometer consists of components controlled by the specialized software. The basic (standard) FluoroMax<sup>®</sup> Plus spectrofluorometer system contains of the following components:

<b>Excitation source</b>	150 W xenon, continuous output, ozone-free lamp
<b>Optics</b>	All-reflective, for focusing at all wavelengths and precise imaging for microsamples.
<b>Dispersion</b>	4.25 nm mm <sup>-1</sup>
<b>Monochromators</b>	Single-grating excitation and emission spectrometers (standard). Monochromators are <i>f</i> /3.5 Czerny-Turner design with classically-ruled gratings and all-reflective optics, using 1200-grooves/mm gratings: Resolution 0.3 nm Maximum scan speed 80 nm s <sup>-1</sup> Accuracy ±0.5 nm Step Size 0.0625–100 nm Range 0–950 nm (physical) Gratings Excitation 330-nm blaze (220–600 nm optical range) Emission 500-nm blaze (290–850 nm optical range)
<b>Sample module</b>	The sample module also has a removable gap-bed assembly for sampling accessory replacement.
<b>Detectors</b>	<ul style="list-style-type: none"> <li>• Calibrated photodiode for excitation reference correction from 200–980 nm.</li> <li>• Emission detector is an R928P for high sensitivity in photon-counting mode (200–850 nm). High voltage = 950 V, linearity to <math>2 \times 10^6</math> counts s<sup>-1</sup>, &lt; 1000 dark counts s<sup>-1</sup>.</li> <li>• Second emission detector as per customer choice</li> </ul>
<b>Sensitivity</b>	Double-distilled, de-ionized, ICP-grade water-Raman scan 3000:1 signal-to-noise ratio at 397 nm, 5-nm bandpass, 1-s integration time, background noise first standard deviation at 450 nm. 400 000 counts s <sup>-1</sup> using these conditions.
<b>Excitation shutter</b>	Computer-controlled
<b>Integration time</b>	0.001–160 s
<b>Slit width</b>	0–30 nm bandpass, continuously adjustable via host computer

<b>Dimensions (instrument)</b>	32 <sup>5</sup> / <sub>8</sub> " wide × 11 <sup>1</sup> / <sub>8</sub> " high × 19 <sup>3</sup> / <sub>4</sub> " deep 82.9 cm wide × 28.3 cm high × 50.2 cm long Height needed to open sample-compartment lid: 20 <sup>1</sup> / <sub>2</sub> "; 52.1 cm
<b>Dimensions (sample compartment only)</b>	5.5" wide × 7" high × 7" long 14.0 cm wide × 17.8 cm high × 17.8 cm long
<b>Weight</b>	75 lbs (34 kg)
<b>Ambient temperature range</b>	15–30°C 59–86°F
<b>Maximum relative humidity</b>	75%
<b>Power</b>	Universal AC single-phase input power; 90–240 V AC; line frequency 50–60 Hz.
<b>Fuses</b>	Two 5 × 20 mm IEC approved, 4.0 A, 250 V, Time Delay fuses (Cooper Bussman part number GDC-4A or equivalent)

## Phosphorimeter option

The following components and specifications also apply to the FluoroMax<sup>®</sup> Plus with FM-2005 upgrade.

<b>Source</b>	UV xenon flash tube
<b>Flash rate</b>	0.05–25 Hz
<b>Lifetime range</b>	Down to 10 μs
<b>Flash duration</b>	3 μs at full-width half-maximum. Low-intensity tail extends > 30 μs.
<b>Delay after flash</b>	50 μs to 10 s, in increments of 1 μs.
<b>Flashes per data point</b>	1–999
<b>Sample window</b>	10 μs to 10 s, in increments of 1 μs.

## TCSPC option (FM4-2015 upgrade)

The following components and specifications also apply to a FluoroMax<sup>®</sup> Plus with FM4-2015 upgrade.

<b>Source</b>	Interchangeable NanoLEDs; peak wavelengths 265 nm–785 nm.
<b>Lifetime range</b>	200 ps–0.1 ms
<b>Minimum resolution</b>	55 ps/channel
<b>Detection method</b>	Time-correlated single-photon counting (TCSPC)

# Minimum host-computer requirements

<b>Microprocessor</b>	Pentium V or higher recommended
<b>Operating system</b>	Windows <sup>®</sup> 7 (in 32-bit compatibility mode)
<b>Hard disk</b>	10 GB of free storage
<b>DVD-ROM drive</b>	Required
<b>Memory</b>	4 GB RAM
<b>Video display</b>	Video resolution of at least 1024 × 768
<b>Keyboard</b>	A 104-key keyboard, plus USB or PS/2 mouse
<b>Available port</b>	Two free USB 2.0 ports



**Note:** Additional COM ports may be required to control accessories such as the MicroMax, temperature bath, etc.

## Software

FluorEssence<sup>™</sup> and Multigroup software for data-acquisition and manipulation through the Windows<sup>®</sup> environment.

# 12: Components & Accessories

Accessories for the FluoroMax<sup>®</sup> Plus can be added to obtain optimum results for a variety of applications. The following list represents all the accessories and components, in alphabetical order, available for the FluoroMax<sup>®</sup> Plus spectrofluorometers. A brief description of each is included in the following sections. Like the list presented below, the descriptions that follow are alphabetized, except where logical order dictates otherwise.

For additional information or product literature on any of these items, contact your local Sales Representative.

# Itemized list of FluoroMax<sup>®</sup> Plus accessories

Item	Model	Page
Assembly, liquid-nitrogen Dewar	FL-1013	12-3
Cell, HPLC flow	J1955	12-4
Cell, Micro, Adapter	F-3011	12-4
Cell, Micro	F-3012	12-4
Cell, quartz	J1925	12-4
Cell, sample	J1920	12-4
Cell, sample (reduced volume, 500 $\mu$ L)	J650518	12-5
Cell-holder, sample (reduced volume, 250 $\mu$ L)	F-3011	12-5
Cell, sample (reduced volume, 250 $\mu$ L)	F-3012	12-5
Cell, sample (Microsense microliter sample cell)	J650604	12-5
Correction Factor Kit	F-3023	12-6
Cryostat, Janis	F-3023	12-8
Fiber-optic bundle	J1950-1M	12-9
Fiber-optic mount	FM4-3000	12-10
Filter, cut-on (2" $\times$ 2")	J1939	12-11
Holder, filter	FM-2008	12-12
Holder, four-position variable temp. control w/ magnetic stirrer	FL4-1011	12-13
Holder, dual-position variable temp. control w/ magnetic stirrer	FL4-1012	12-15
Holder, single-position variable temp. control w/ magnetic stirrer	FL4-1027	12-17
Holder, solid-sample	J1933	12-19
Injector, autotitration	F-3005/6	12-20
Lamp, xenon replacement, 150-W	1905-OFR	12-22
Peltier drive, sample heater/cooler	F-3004	12-23
Plate reader, MicroMax 384 microwell	MicroMax 384	12-25
Polarizer, L-format	FM4-2000	12-26
Port, injector	FL4-1015	12-27
Quantum-Yield accessory, Quanta- $\phi$ integrating sphere	F-3029	12-28
Shutter, emission	FM-2002	12-29
Stopped-flow accessory	F-3025	12-30
	F-3025M	
TCSPC upgrade	FM4-2015	12-31
	FM4-2016	
Temperature bath	F4-3030	12-32
	F4-3030-220	
Transmission accessory	F-3031	12-33
Trigger cable	J400981	12-34
Windows for the FluoroMax <sup>®</sup> -4 sample compartment	FM-2007	12-35

# FL-1013 Liquid Nitrogen Dewar Assembly



**Caution:** Refer to your Material Safety Data Sheet (MSDS) for information on the hazards of cryogenic materials such as liquid nitrogen.

For phosphorescence or delayed fluorescence measurements, samples are often frozen at liquid-nitrogen temperature (77 K) to preserve the fragile triplet state. The sample is placed in the quartz cell and slowly immersed in the liquid-nitrogen-filled Dewar flask. The white Teflon<sup>®</sup> cone in the bottom of the Dewar flask keeps the quartz sample-tube centered in the Dewar flask. The Teflon<sup>®</sup> cover on the top of the Dewar flask holds any excess liquid nitrogen that bubbled out of the assembly. A pedestal holds the Dewar flask in the sampling module. A special stove-pipe sample cover replaces the standard sample lid, so that liquid nitrogen can be added to the Dewar flask as needed. The Dewar flask holds liquid nitrogen for at least 30 min with minimal outside condensation and bubbling.

Included in the FL-1013 Liquid Nitrogen Dewar Assembly, the Dewar flask can be purchased as a spare. The bottom portion, which sits directly in the light path, is constructed of fused silica.



**Note:** If condensation appears on the outside of the Dewar flask, it must be re-evacuated.



**FL-1013 Liquid Nitrogen Dewar Assembly.**

# Sample cells



**Caution:** Always read the Material Safety Data Sheet (MSDS) to understand the hazards of handling your sample.

## J1955 HPLC Flow Cell

With a sample capacity of 20  $\mu\text{L}$ , this non-fluorescing fused silica cell is ideal for on-line monitoring of fluorescent samples. The cell maintains high sensitivity because it has a large aperture for collecting the excitation light to the sample and fluorescence emission from the sample. The flat sides allow maximum throughput while keeping the scattering of the incident radiation to a minimum. The cell fits in a standard cell holder.

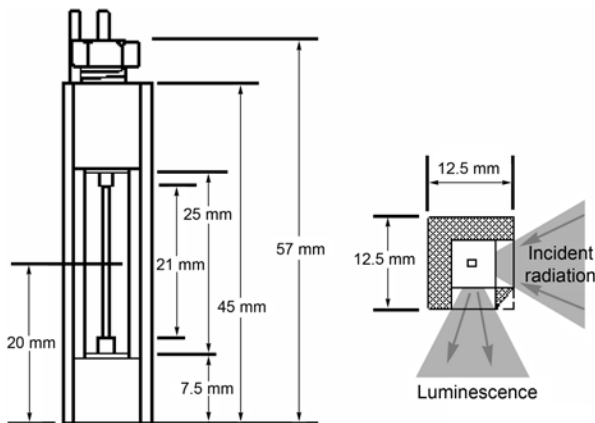

## F-3011 Micro Cell Adapter

This is the adapter to hold the F-3012 Micro Cell in the Sample Holder.

## F-3012 Micro Cell

This non-fluorescing fused silica cylindrical cell holds 250  $\mu\text{L}$ . A magnetic stirrer cannot be used with this cell.

## J1925 Quartz Cuvette

With a 4-mL volume, this cell measures 10 mm  $\times$  10 mm in cross-section, and comes with a Teflon® stopper to contain volatile liquids.

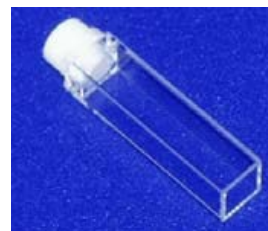

## J1920 Sample Cell

This 2-mL to 4-mL non-fluorescing fused silica cell, can accept a magnetic stirrer, has a 10-mm path length, and includes a white Teflon® cap that prevents sample evaporation.





## J650518 Reduced-Volume Sample Cell

This non-fluorescing fused silica cell is selected for samples with a volume of 500  $\mu\text{L}$ . The square cross-section of the sample cavity is 5 mm. The precise imaging capability of the excitation light focused onto the sample allows for high sensitivity. The adapter (J650519) and a “flea” magnetic stirrer are included.

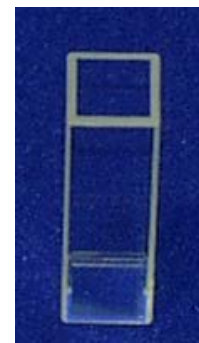

## J650604 Microsense microliter sample cell

To measure fluorescence of ultra-small samples with volumes less than 10  $\mu\text{L}$ , HORIBA Scientific offers the Microsense. This microliter sample cell allows you to add your sample via a pipette, without dilution for easy recovery. The Microsense provides accurate, repeatable fluorescence measurements.



# F-3026 Correction Factor Kit

The F-3026 Correction Factor Kit is an NIST-traceable accessory for the FluoroMax® and Fluorolog® spectrofluorometers for calibrating the relative spectral response of the spectrofluorometer, and includes a Spectralon® integrating sphere as a sampling optic. Each Correction Factor Kit includes a regulated 12 VDC power supply, a calibration certificate, and a CD with data files for use with FluorEssence™ software. The Correction Factor Kit provides 50 hours of operation before recalibration is necessary.



**Warning:** Tungsten-halogen lamps can be dangerous. They pose a risk of explosion, and are a source of potentially hazardous bright light.

## F-3023 Janis cryostat

The F-3023 Janis cryostat VNF-100 is a liquid-nitrogen variable-temperature cryostat with the sample located in flowing vapor. Ideal for experiments with samples that are difficult to thermally anchor, e.g., liquids or powders, the F-3023 features a top-loading sample chamber for rapid sample-exchange, and four-way  $f = 1.0$  optical access to the sample chamber.

Among the cryostat's features are:

- Quick refill with included funnel assembly.
- High-quality bellows-sealed evacuation valve and a built-in cryopump for maintaining high vacuum.
- Safety pressure-relief valves protecting all independent spaces.
- Variable cooling system which places the sample in flowing N<sub>2</sub> vapor (ideal for low thermal conduction samples), providing excellent cooling power and temperature control.
- Light-weight sample positioner/mount assembly, with multi-pin electrical-feedthrough access to the window region, offering rotation and translation around the cryostat's axis.
- Two silicon diodes installed on the vaporizer (heat exchanger) and sample mount, for controlling and monitoring the system temperature.



**Caution:** Refer to your Material Safety Data Sheet (MSDS) for information on the hazards of cryogenic materials such as liquid nitrogen.

# FM4-3000 Fiber Optic Mount and J1950 Fiber Optic Bundles

Now you can study marine environments, skin and hair, or other large samples *in situ*! For those users who want to examine samples unable to be inserted into the sample compartment, the FM4-3000 Fiber Optic Mount (plus fiber-optic bundles) allows remote sensing of fluorescence. The FM4-3000 couples to the sample compartment; light is focused from the excitation monochromator onto the fiber-optic bundle, and then directed to the sample. Fluorescence emission from the sample is directed back through the bundle and into the front-face collection port in the sample compartment. Randomized fiber-optic bundles (J1950) ranging in length from 1 meter to 5 meters are available. Contact the local Sales Representative for details.

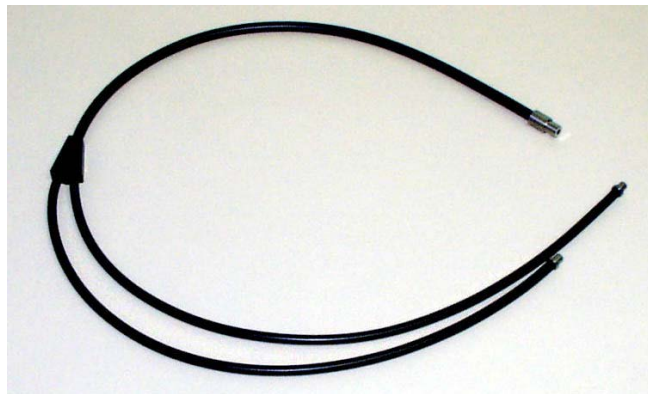

FM4-3000 Fiber Optic Mount (above) and J1950 fiber-optic bundle (below).



**Caution:** Intense ultraviolet, visible, or infrared light may be present when the sample compartment is open. Do not aim fiber-optic bundles onto the skin or eyes. Use extreme caution with the fiber-optic probes.

# J1939 Cut-On Filter

The model J1939 Cut-On Filter set consists of five 2" × 2" filters with cut-on wavelengths of 370 nm, 399 nm,

450 nm, 500 nm, and 550 nm. To position the filter properly, the FM-2008 Filter Holder is required. The sample compartment has slots to hold the Model FM-2008 filter holder in the emission and excitation light-path positions. To eliminate second-order effects from an excitation spectrum, install the filter holder and the appropriate cut-on filter in the excitation light path.

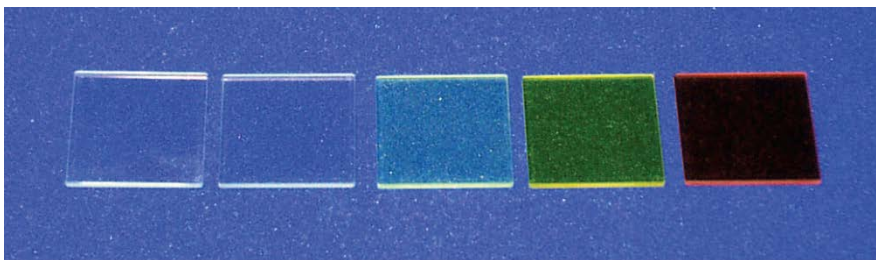

Cut-on filters eliminate second-order effects of the gratings. For example, if sample excitation is at 300 nm, a second-order peak occurs at 600 nm. If the emission spectrum extends from 400 nm to 650 nm, a sharp spike occurs at 600 nm. This peak is the second-order peak of the excitation monochromator. To remove this unwanted peak in the emission spectrum, place a 350 nm filter in the emission slot. Cut-on filters typically are used for phosphorescence measurements, where second-order effects are common.

# FM-2008 Cut-On Filter Holder

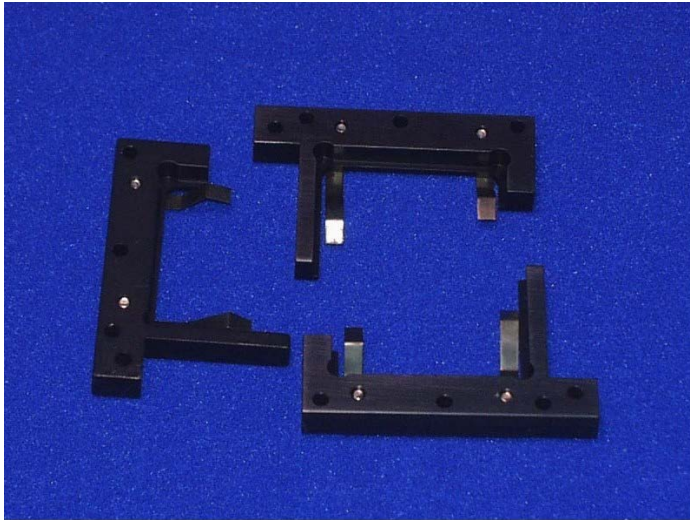

Cut-on filters eliminate second-order effects of the gratings. The sample compartment has three slots that can hold the FM-2008 Filter Holder. Refer to the J1939 Cut-On Filter for a detailed description of the placement of the filter holder and the interaction of the cut-on filters and the holder.

# FL4-1011 Four-Position Thermostatted Cell Holder

The FL4-1011 Four-Position Thermostatted Cell Holder keeps a sample at a constant temperature from  $-20^{\circ}\text{C}$  to  $+80^{\circ}\text{C}$ . The temperature is maintained by an ethylene-glycol-water mixture pumped through from an external circulating temperature bath (not included). The holder also includes a magnetic stirrer, for mixing turbid or viscous samples. Also required is the FM-2003 Sample Compartment Accessory.

## FL4-1011 Four-Position Thermostatted Cell Holder.



 **Caution:** Refer to your Material Safety Data Sheet (MSDS) for information on the hazards of an ethylene-glycol-water mixture.

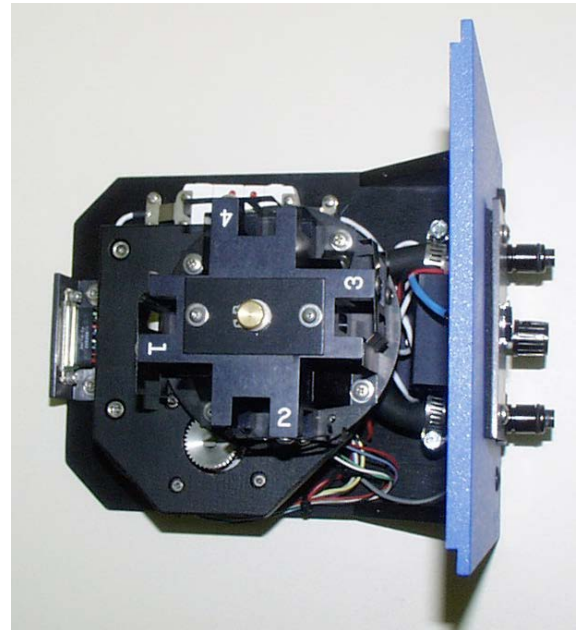

## Installation

- 1 Remove the sample-compartment gap-bed.
- 2 Position the FL4-1011 gap-bed drawer.
- 3 Tighten with four screws.
- 4 Attach the  $\frac{1}{4}$ " tubing to the brass inlets on the bottom of the holder.



 **Caution:** Failure to clamp these hoses securely may result in flooding and damage to the optics and electronics of the instrument.

## Use

- 1 Place the sample in a 10 mm × 10 mm cuvette and insert a magnetic stirring bar.

The stirring bar is available from Bel-Art Products, Pequannock, NJ.



**Note:** While the four-position model maintains the temperature of all four samples, only one sample is mixed at a time.

- 2 Place a cuvette in each holder.
- 3 Allow the samples to reach the desired temperature.
- 4 Turn on the magnetic stirrer.
- 5 Select the appropriate mixing speed.

The speed at which the sample should be mixed depends on the viscosity of the sample.



**Note:** Selecting too high a speed may create a vortex, which could affect the reproducibility of the measurement.

- 6 Run your experiment as usual.
- 7 Place the next cuvette in the sample position by lifting up the knob and rotating the holder.

Be sure to press down, to lock the cuvette into the proper position.



# FL4-1012 Dual-Position Thermostatted Cell Holder

The FL4-1012 Dual-Position Thermostatted Cell Holder keeps a sample at a constant temperature from  $-20^{\circ}\text{C}$  to  $+80^{\circ}\text{C}$ . The temperature is maintained by an ethylene-glycol-water mixture pumped through from an external circulating temperature bath (not included). The holder also includes a magnetic stirrer, enabling mixing of turbid or viscous samples. Also required is the FM-2003 Sample Compartment Accessory.

## FL4-1012 Dual-Position Thermostatted Cell Holder.



**Caution:** Refer to your Material Safety Data Sheet (MSDS) for information on the hazards of an ethylene-glycol-water mixture.

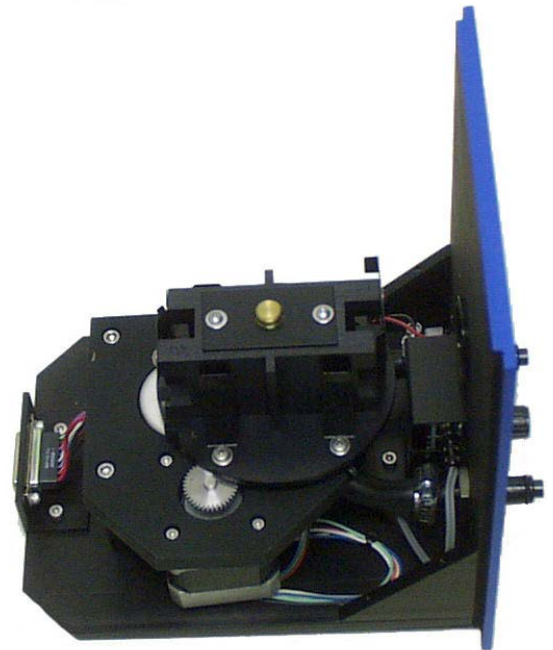

## Installation

- 1 Remove the present holder from the posts.
- 2 Replace with the FL4-1012.
- 3 Tighten the two thumbscrews.
- 4 Attach the  $\frac{1}{4}$ " tubing to the brass inlets on the bottom of the holder.



**Caution:** Failure to clamp these hoses securely may result in flooding and damage to the optics and electronics of the instrument.

## Use

- 1 Place your sample in a 10 mm × 10 mm cuvette and insert a magnetic stirring bar.

The stirring bar is available from Bel-Art Products, Pequannock, NJ

- 2 Place a cuvette in each holder.



**Note:** While the two-position model maintains the temperature of both samples, only one sample is mixed at a time.

- 3 Allow the sample to reach the desired temperature.
- 4 Turn on the magnetic stirrer.
- 5 Select the appropriate speed.

The speed at which the sample should be mixed depends on the viscosity of the sample.



**Note:** Selecting too high a speed may create a vortex, which could affect the reproducibility of the measurement.

- 6 Run your experiment as usual.

# FL4-1027 Single-Position Thermostatted Cell Holder

The FL4-1027 Single-Position Thermostatted Cell Holder keeps a sample at a constant temperature from  $-20^{\circ}\text{C}$  to  $+80^{\circ}\text{C}$ . The temperature is maintained by an ethylene-glycol–water mixture pumped through from an external circulating temperature bath (not included). The holder also includes a magnetic stirrer, enabling mixing of turbid or viscous samples. Also required is the FM-2003 Sample Compartment Accessory.



**Caution:** Refer to your Material Safety Data Sheet (MSDS) for information on the hazards of an ethylene-glycol–water mixture.



## Installation

- 1 Remove the present holder from the posts.
- 2 Replace with the FL4-1027.
- 3 Tighten the two thumbscrews.
- 4 Attach the  $\frac{1}{4}$ " tubing to the brass inlets on the bottom of the holder.



**Caution:** Failure to clamp these hoses securely may result in flooding and damage to the optics and electronics of the instrument.

## Use

- 1 Place your sample in a 10 mm × 10 mm cuvette and insert a magnetic stirring bar.

The stirring bar is available from Bel-Art Products, Pequannock, NJ

- 2 Place the cuvette in the holder.
- 3 Allow the sample to reach the desired temperature.
- 4 Turn on the magnetic stirrer.
- 5 Select the appropriate speed.

The speed at which the sample should be mixed depends on the viscosity of the sample.



**Note:** *Selecting too high a speed may create a vortex, which could affect the reproducibility of the measurement.*

- 6 Run your experiment as usual.

# J1933 Solid Sample Holder

## Introduction

The J1933 Solid Sample Holder is designed for samples such as thin films, powders, pellets, microscope slides, and fibers. The holder consists of a base with a dial indicating angle of rotation, upon which a bracket, a spring clip, and a sample block rest.

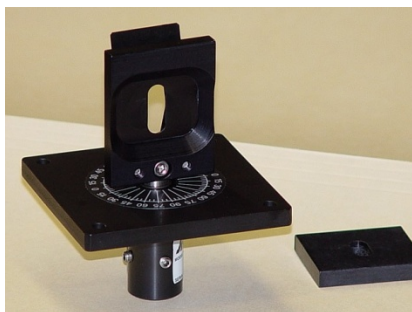

**J1933 Solid Sample Holder  
(with sample block nearby).**

## Installation

- 1 Remove the present holder.
- 2 Position the base on the posts.
- 3 Tighten the two thumbscrews.

For pellets, crystals, creams, gels, powders, and similar materials:

- 1 Fill the well of the block.
- 2 Place a quartz coverslip or Teflon<sup>®</sup> film over the well.

This holds the sample in place when vertically positioned.

- 3 Carefully insert the block between the bracket and spring clip, so that the sample is angled approximately 60° to the excitation light.

This prevents reflections from entering the emission monochromator, and lets the fluorescence emission to be measured with minimal interference from scattered light.



**Caution:** Always read the Material Safety Data Sheet (MSDS) to understand the hazards of handling your sample.

Use with samples such as thin films, microscope slides, fibers, or other materials:

- 1 Place the material on the block on the side opposite that of the well.



**Caution:** Always read the Material Safety Data Sheet (MSDS) to understand the hazards of handling your sample.

- 2 Carefully insert the block between the bracket and spring clip, so that the sample is angled approximately 60° to the excitation light.

This prevents reflections from entering the emission monochromator, and lets the fluorescence emission to be measured with minimal interference from scattered light.

# F-3005/6 Autotitration Injector

For controlled, automatic injection of aliquots into the sample of your choice, the F-3005/6 Autotitration Injector is just the thing, available in both 110-V (F-3005) and 220-V (F-3006) models. The F-3005/6 comes with dual syringes, for complete control over dispensing and aspirating volumes of liquids into and out of the sample cell. A mix function is included. With the injector come 18-gauge Teflon<sup>®</sup> tubing and two syringes (1 mL and 250  $\mu$ L). The syringes are interchangeable; aliquot size is controllable to 0.1% of total syringe volume.



**F-3005/6 AutoTitrator Injector.**



**Caution:** Always read the Material Safety Data Sheet (MSDS) to understand the hazards of handling your sample.

# 1905-OFR 150-W Xenon Lamp

The 1905-OFR 150-W xenon lamp delivers light from 240 nm to 850 nm for sample excitation. The lamp has an approximate life of 1500 hours, and is ozone-free.



**Caution:** This lamp emits intense light and heat, and contains xenon gas under pressure. Understand all safety precautions before handling or using this xenon-arc lamp.



# F-3004 Sample Heater/Cooler Peltier Thermocouple Drive

For rapid control of the sample's temperature in the FluoroMax<sup>®</sup> Plus's sample compartment, choose the F-3004 Peltier Drive. Instead of messy fluids, the Peltier device heats and cools the sample thermoelectrically and fast! The temperature range is  $-10^{\circ}\text{C}$  to  $+110^{\circ}\text{C}$ . To prevent condensation of moisture on chilled cuvettes, an injection port for dry nitrogen gas is provided. All software is included, along with a controller and stirring mechanism.

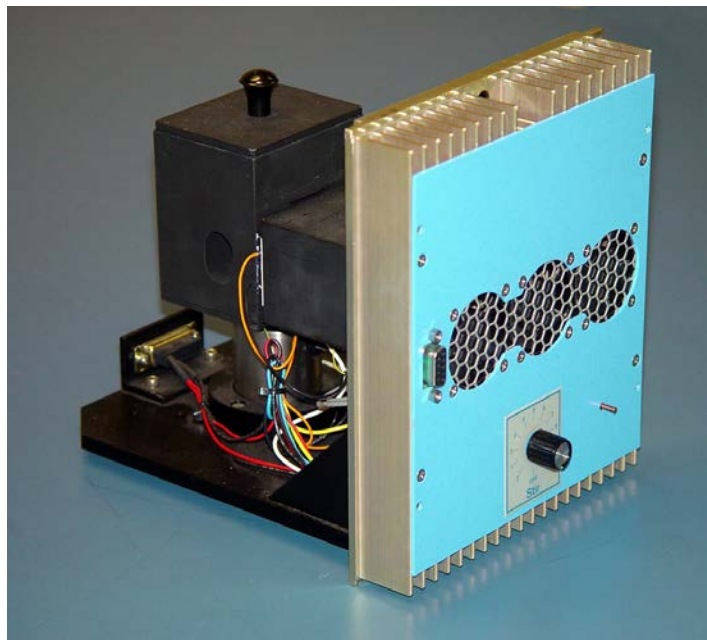

**F-3004 Sample Heater/Cooler Peltier Thermocouple Drive.**

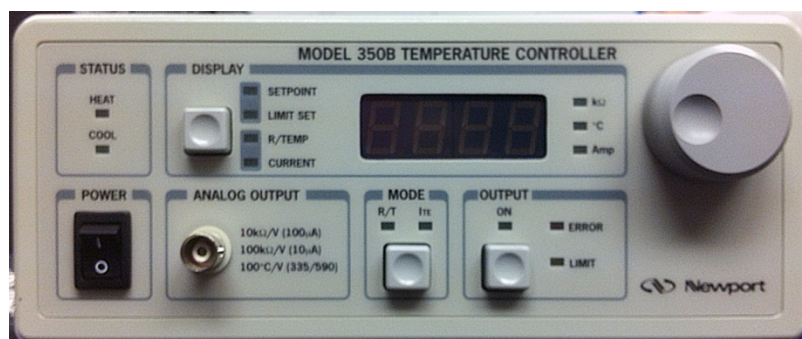

**Peltier Controller.**

# MicroMax 384 Microwell Plate Reader



The MicroMax 384 Microwell Titer-Plate Reader allows multiple samples to be scanned in one experiment. The MicroMax 384 is controlled through the FluoroEssence™ software via a serial port to the host computer. The titer plate moves beneath a stationary optical beam, and fluorescence measurements are collected with top-reading geometry. Thus, any titer plates—even disposable ones—may be used. Up to 384-well plates may be inserted into the MicroMax 384, with a rapid scan speed. Various scan types are possible:

- Single-Point Analysis
- Emission
- Synchronous
- Excitation
- Time-Based
- Multigroup

Signals are transmitted between the FluoroMax®-4 and the MicroMax via a fiber-optic bundle.



**Caution:** Intense ultraviolet, visible, or infrared light may be present when the sample compartment is open. Do not aim fiber-optic bundles onto the skin or eyes. Use extreme caution with the fiber-optic probes.



**Caution:** Always read the Material Safety Data Sheet (MSDS) to understand the hazards of handling your sample.

## FM4-2000 L-Format Polarizer

For L-format spectrofluorometers such as the FluoroMax<sup>®</sup> Plus, the FM4-2000 dual polarizer is ideal. The kit includes two polarizers, placed at the optical entrance and exit of the sample compartment. The polarizers are fully automated, and are adjustable to within 1° rotation. Insertion and removal of the polarizers from the optical path is controlled by the host computer.

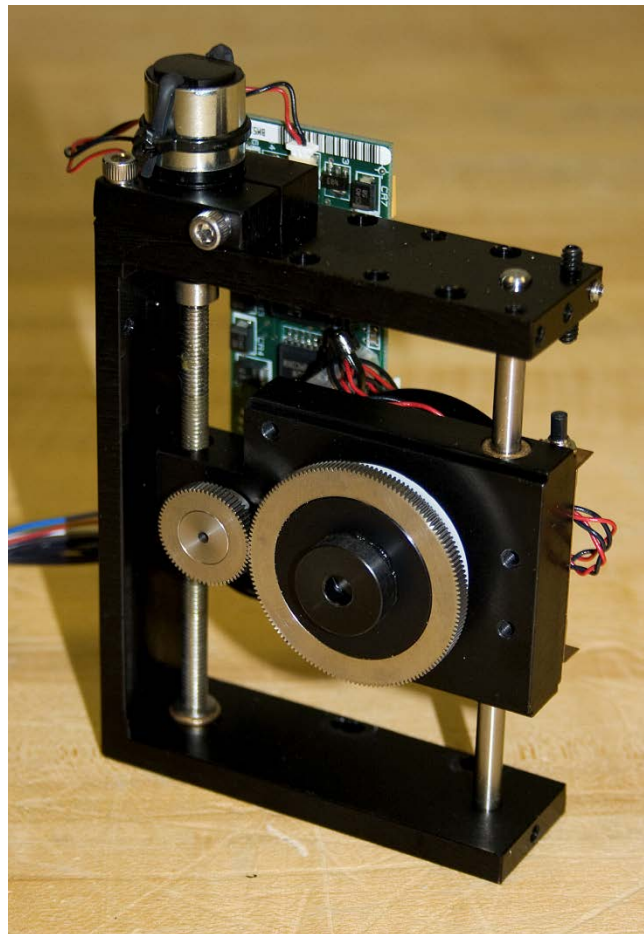

**Caution:** Intense ultraviolet, visible, or infrared light may be present when the sample compartment is open, so avoid looking at the beam or its reflections. Do not aim fiber-optic bundles onto the skin or eyes. Use extreme caution with the fiber-optic probes.

## FL4-1015 Injector Port

For the study of reaction kinetics, such as  $\text{Ca}^{2+}$  measurements, the FL4-1015 Injector Port is ideal. This accessory allows additions of small volumes via a syringe or pipette to the sample cell without removing the lid of the sample compartment. With the injector in place, a lock-tight seal is achieved, prevented both light and air from reaching the sample.

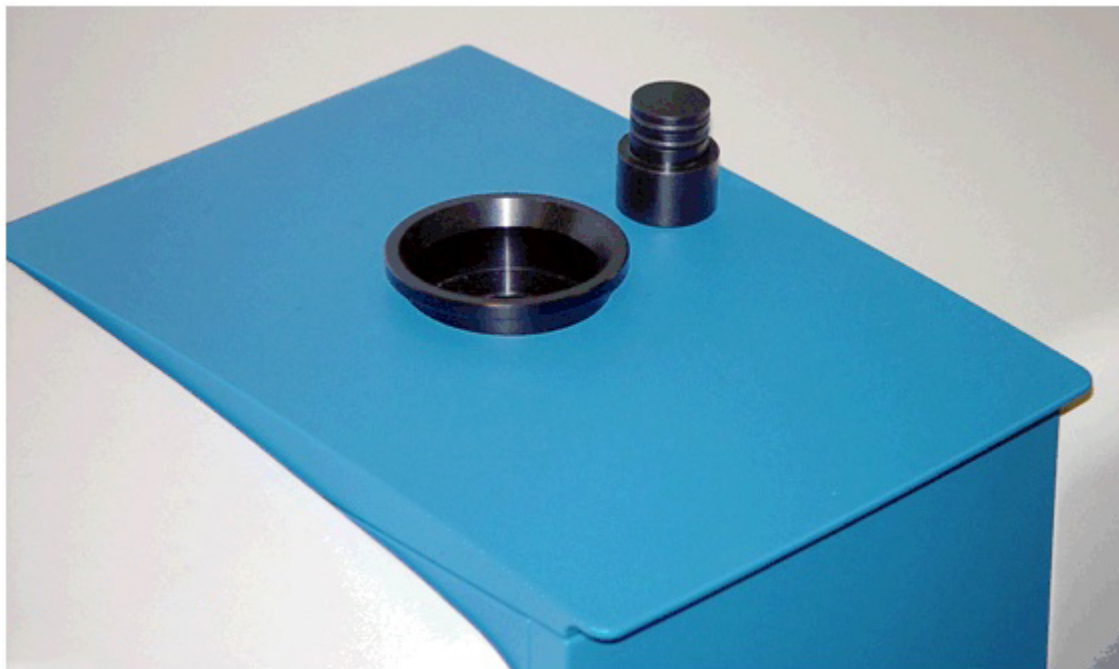

The Injector Port will accommodate most pipettes and syringes, with an injection-hole diameter of 0.125" (3.2 mm). A cap is included to cover the port when not in use.



**Caution:** Always read the Material Safety Data Sheet (MSDS) to understand the hazards of handling your sample.

# F-3029 Quanta-φ accessory

The F-3029 Quanta-φ integrating sphere is used in the FluoroMax® Plus spectrofluorometer to study fluorescence from solid and liquid samples. The sphere has an internal diameter of 6" (15 cm). Of special interest is the measurement of photoluminescence quantum yields of such materials, especially for thin solid films. Measurement of quantum yields of solids requires more complicated apparatus when an integrated sphere is unavailable. The integrating sphere's base mounts directly on the gap-bed, and is inserted into the spectrofluorometer's sample compartment. Exclusive HORIBA Scientific software is included for automatic calculation of quantum yields, absorptions, and CIE (1931 and 1976) color values.



**Quanta-φ.**

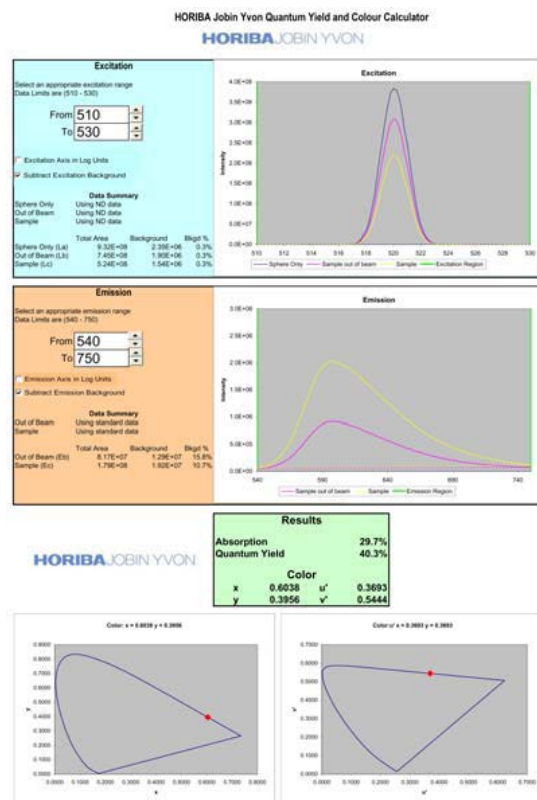

**Caution:** Always read the Material Safety Data Sheet (MSDS) to understand the hazards of handling your sample.

**Quantum Yield and Color Calculator software.**

# FM-2002 Shutter accessory

The FM-2002 Shutter accessory is entirely controlled from your software. As an added feature, it includes a microswitch on the sample-compartment lid to activate the shutter when the sample compartment is opened. This protects the detector from unwanted excess light.



## F-3025 Stopped-flow accessory

The stopped-flow rapid-kinetics accessories F-3025 and F-3025M offer versatility for spectroscopic monitoring of fast reactions in solution.

In addition to the conventional two-syringe mixing system, there is also a three-syringe version with two sequential mixers in the cell, giving you an option to do double-mixing. Further choices include a micro-volume version, reducing the volumes of reagents required to load the instrument, and thus improve sample economy.



The stopped-flow accessory permits observation of the reaction rate of two reactants forced through a mixing chamber, and into an observation cell. The reactant solutions are contained in drive syringes whose pistons simultaneously are driven. After leaving the observation cell, the reactants advance a stop syringe, triggering data-acquisition by the spectrofluorometer.

This accessory has been designed to suit the particular needs of FluoroMax<sup>®</sup> spectrofluorometers. The optical cell matches the beam geometry of this instrument. A cable is supplied so data-acquisition can be externally triggered at stopping, providing a reproducible time-zero registration for all traces, and allowing accurate overlay and averaging.

Model F-3025 includes 600 mm of tubing, while F-3025M has 300 mm of tubing.



**Caution:** Always read the Material Safety Data Sheet (MSDS) to understand the hazards of handling your sample.

# FM4-2015 and FM4-2016 TCSPC upgrade

Now you can have the speed and versatility you've come to expect in the FluoroMax<sup>®</sup> Plus, with the bonus of pico- and nanosecond lifetime capability. Time-correlated single-photon counting, or TCSPC, is perfect for dynamic anisotropy, TRES, and virtually any application requiring time-resolution, all with the ultimate, unrivaled sensitivity of digital photon-counting that strips away the noise, rather than adding noise to your signal the way an analog system does.



The pulsed source used in the TCSPC upgrade is our NanoLED solid-state pulsed diode, which can be ordered from a full spectrum of wavelengths ranging from deep-UV to near-IR.

The TCSPC upgrade for the FluoroMax<sup>®</sup> Plus includes all electronics, a special sample compartment, and your choice of NanoLED.



**Caution:** Intense ultraviolet, visible, or infrared light may be present when the sample compartment is open. Do not aim fiber-optic bundles onto the skin or eyes. Use extreme caution with the fiber-optic probes.



# F4-3030 Temperature Bath

For studies of samples whose properties are temperature-dependent, use the F4-3030 Temperature Bath. The controller circulates fluids externally, with tubes leading to the sample chamber. The temperature range is from  $-25^{\circ}\text{C}$  to  $+80^{\circ}\text{C}$ . Sensor and all cables are included with the F4-3030 and F4-3030-220. The Temperature Bath is available in a 110 V (F-3030) and 220 V (F4-3030-220) version.



**Warning:** Refer to your Material Safety Data Sheet (MSDS) for information on the hazards of an ethylene-glycol–water mixture.

*This instrument uses high-temperature fluids, which can cause severe burns.*

# F-3031 Transmission Accessory

The F-3031 Transmission Accessory allows you to collect absorbance (transmittance) spectra of fluorescence samples. Such spectra can be used to verify that sample concentrations are appropriate, or even to correct for inner-filter effects. It comes assembled as a complete gap-bed, ready to insert into the FluoroMax<sup>®</sup> Plus's sample compartment.

The spectral range is 220–1000 nm. The F-3031 includes a DM303 electronics module and required cables. When used, it is configured as an “A” (auxiliary) detector in the instrument configuration.

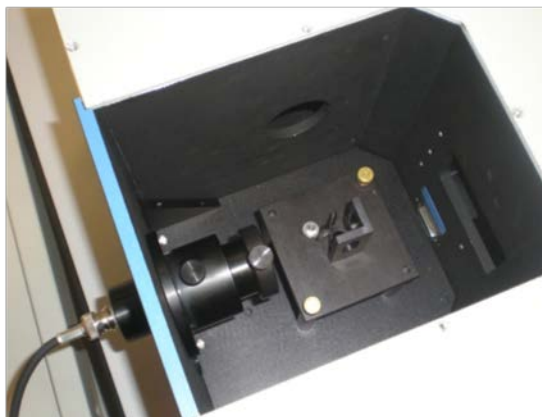

# J400981 Trigger Cable

The J400981 Trigger Cable permits the fluorescence system to be triggered by hand.



**J400981 Trigger Cable.**

The Trigger Cable is attached to the FluoroMax<sup>®</sup> via the BNC TRIGGER jack on the side of the instrument. Simply press the button on the end of the cable to start the scan.

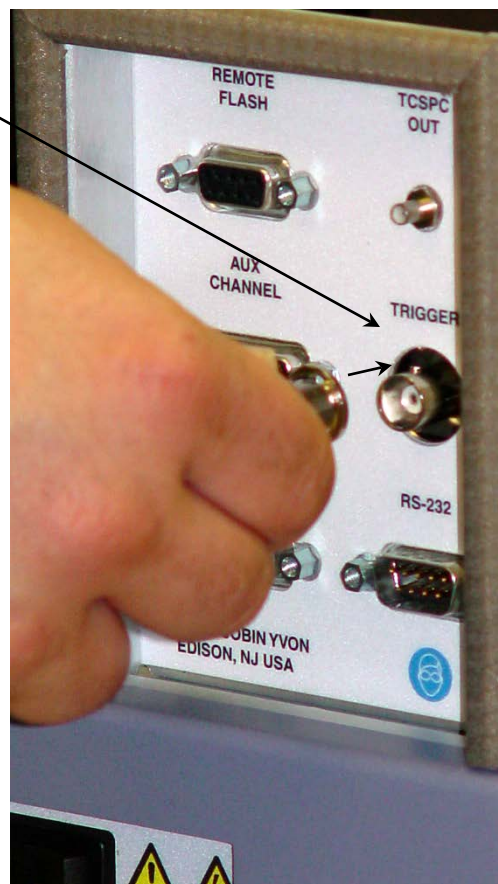

# FM-2007 Windows for the FluoroMax<sup>®</sup>-4

The FM-2007 Windows accessory assists you in experiments that require special atmospheres for your samples, for example, dry nitrogen. The windows provide for a clear optical path while preventing harmful gases or vapors from attacking your sample. In addition, a purge port allows free escape of dry nitrogen from the sample chamber.

**Purge port**

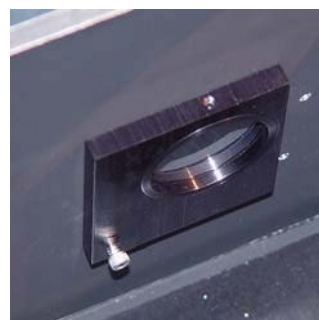
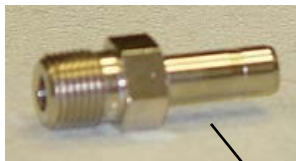

**Window mounted inside the instrument**

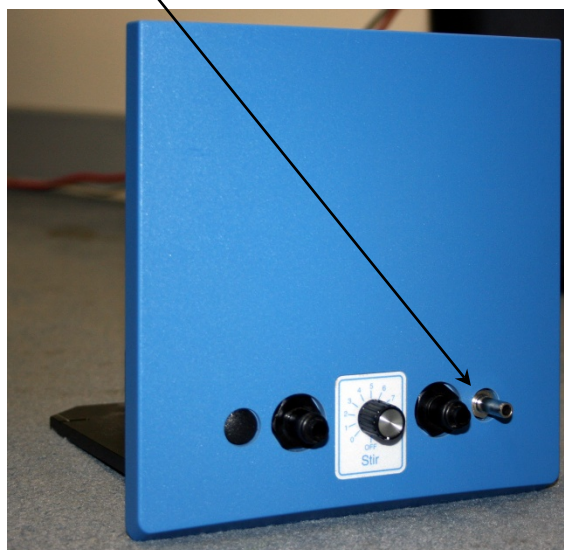

**Purge port mounted on the front of the FluoroMax<sup>®</sup>-4's sample compartment**

# 13 : Glossary

Absorption	Transition, when a photon enters a molecule, from the ground state to the excited singlet state. This process typically occurs in $\sim 10^{-15}$ s.
Absorbance	The extent of light absorption by a substance. Absorbance, $A = -\log T$ , where $T$ is the transmittance of the sample. Absorbance is also synonymous with optical density, OD. Absorbance can be calculated using the Beer-Lambert Law: $A = \epsilon cl = OD = -\log T$ $\epsilon = \text{extinction coefficient (} M^{-1} \text{ cm}^{-1}\text{)}$ $C = \text{sample concentration (} M\text{)}$ $l = \text{path length (cm).}$
Acquisition modes (R, S channels)	The logical input channels used on the spectrofluorometer to input collected signal from the detectors present on the system. The detectors are assigned as: the reference detector connected to channel R, and the emission connected to channel S. These logical channel names are used in the collection of data in most FluorEssence <sup>™</sup> applications. The user may create algebraic expressions on these input channels when defining experiments in FluorEssence <sup>™</sup> (e.g., S/R).
Anisotropy ( $\langle r \rangle$ )	A measurement of the fluorescence polarization of a samples, defined as the linear-polarizer's component's intensity divided by the total light intensity. The measurement of anisotropy can provide insight into molecular size and shape, as well as the environment that surrounds it.
Autopolarizers	An automated device to hold and precisely rotate a set of polarizers to acquire anisotropy (or polarization) measurements. FluoroMax <sup>®</sup> Plus systems with autopolarizers contain two automated polarizer mounts, one for the excitation polarizer and one for the emission polarizer. Both are located between the sample compartment and their respective monochromators. Their calibration is maintained by optical sensors that are offset in the software. Autopolarizers on the FluoroMax <sup>®</sup> Plus may be inserted into and out of the light path in FluorEssence <sup>™</sup> , in the Experiment Setup window, under the Accessories icon. (Automated realignment of the polarizers also may be performed here.)

Bandpass	The wavelength range of light passing through the excitation and emission spectrometers. The wider the bandpass, the higher the signal intensity.
Bandpass filter	Optical element that selectively transmits a narrow range of optical wavelengths.
Bioluminescence	Emission of light originating from a chemical reaction in a living organism.
Blank subtraction	The removal of the spectral response of the solvent (and sample container) from the sample's spectral response. To accomplish this, an identical scan is run on the solvent just before running the actual sample. Proper use of a blank can remove solvent luminescence artifacts, scattering events, and any artifacts from the sample cuvette or container. In the Experiment Setup window, under the Detectors icon, check the Blank Subtract checkbox to acquire a blank.
Blaze wavelength	Wavelength at which a grating is optimized for efficiency. Generally, the gratings are efficient to $\frac{2}{3}$ before the blaze wavelength to twice the blaze wavelength. The excitation and emission gratings are blazed in the UV and visible respectively.
Chemiluminescence	Emission of light originating from a chemical reaction.
Color effect for pulse technique	Time-dependent wavelength distribution of the lamp pulse.
Concentration determination	A function of the Single Point type of scan that calculates an unknown sample's concentration. The user runs known samples and enters the concentration in order to calibrate the routine. Then an assay may be completed with the measurements based on concentration.
Corrected emission scan	An emission scan that has been corrected for the wavelength response of the emission monochromator and the signal detector. To obtain a corrected emission scan, an emission spectrum is multiplied by the appropriate emission correction-factor file. A set of emission correction factors is supplied with the instrument and stored under the name MCORRECT.SPC.
Corrected excitation scan	An excitation scan corrected for the wavelength-characteristics of the xenon lamp, the aging of the xenon lamp, and the gratings in the excitation spectrometer. To obtain a first-order correction of the excitation scan, the emission detector signal is ratioed to the reference signal (i.e., S/R). This provides correction for the lamp and

	excitation-monochromator spectral response, which is ~95% of the required correction. To obtain a completely correct scan, the excitation scan acquired in the S/R acquisition mode is multiplied by excitation correction factors. A set of excitation correction factors ( <code>XCORRECT.SPC</code> ) is included.
Correction factors	Compensates for the wavelength-dependent components of the system, like the xenon lamp, gratings, and signal detector. Emission and excitation correction-factor files are included with the software and are titled <code>xcorrect.spc</code> and <code>mcorrect.spc</code> .
CTI card	This acquisition and control card, located in the rear of the FluoroMax <sup>®</sup> Plus, is the counter-timer-integrator board. It handles all spectrofluorometer control, timing, and data-acquisition for measurements on the system. The boards carry by default two acquisition channels, and are linked to all monochromator and accessory control boards on the underside of the instrument. The CTI card fits into a slot in the motherboard on the rear of the FluoroMax <sup>®</sup> Plus.
Current input module (DM303)	The current input module collects the current signal from the reference photodiode, digitizes the data, and sends it to the CTI card for data-processing. This module is located directly behind the reference photodiode. It has linear response from 0–10 $\mu\text{A}$ .
Cut-on filter	Optical component that passes light of a higher wavelength.
Cut-off filter	Optical component that passes light of a lower wavelength.
Dark counts	Inherent background signal measured in counts $\text{s}^{-1}$ (cps) observed on the photomultiplier tube when high voltage is applied. Typically, the R928P photomultiplier tube used for the FluoroMax <sup>®</sup> Plus system has dark counts $< 1000$ cps.
Dark offset	The software correction used to subtract dark counts (or dark signal) on a detector from a spectral acquisition. This option appears as a checkbox in the FluorEssence <sup>™</sup> software. Use a corrected signal channel for the acquisition (e.g., S) in order to run the Dark Offset correction.
Datafile	A file used to store spectral data, constant-wavelength analysis data, or other recorded data. In FluorEssence <sup>™</sup> , the most common datafile is the spectral file ( <code>.SPC</code> ). This is the file-type that contains spectra acquired from a scan run from the Experiment Setup menu (e.g., emission scan, time-base scan, single-point, etc.).
Dispersion	The range of wavelengths of light across the field of view of the entrance and exit apertures. Dispersion depends on the focal length

	<p>of the monochromator, the groove density of the optics, and the <math>f</math>-number (speed) of the monochromator. Dispersion is usually expressed in nanometers of spectral coverage per millimeters of slit width (nm/mm).</p>
Emission monochromator	<p>The monochromator located after the sample compartment used to isolate discrete wavelength components of the sample's fluorescence, and may be used to scan the emission from a sample. The emission monochromator on the FluoroMax<sup>®</sup> Plus is an 0.18-m single monochromator with a Czerny-Turner design: the monochromator includes a collimating mirror, the reflection grating (blazed at 500 nm), and a focusing mirror, with slit apertures at the entrance and exit. The emission-photomultiplier detector is connected to the exit of this monochromator to measure the fluorescence emission.</p>
Emission scan	<p>Shows the spectral distribution of light emitted by the sample. During an emission scan, the excitation monochromator remains at a fixed wavelength while the emission monochromator scans a selected region.</p>
Energy transfer	<p>The transfer of the excited energy from a donor to an acceptor. The transfer occurs without the appearance of a photon and is primarily a result of dipole-dipole interactions between the donor and acceptor.</p>
Excitation/emission matrix (EEM)	<p>A three-dimensional plot showing the total luminescence from a sample across all useful wavelengths. Total luminescence spectroscopy is devoted to measurements of these EEMs for various materials. See also: Total Luminescence Spectroscopy</p>
Excitation monochromator	<p>The monochromator, located between the xenon lamp and the sample compartment, used to isolate discrete wavelength components of the excitation beam. This beam is directed to the sample, during which the excitation monochromator may be used to scan the excitation spectrum from a sample. The excitation monochromator on the FluoroMax<sup>®</sup> Plus is an 0.18-m single monochromator with Czerny-Turner design. This means that the monochromator includes a collimating mirror, the reflection grating (blazed at 330 nm), and a focusing mirror, with slit apertures at the entrance and exit. An excitation shutter is located directly after the excitation exit slit to protect the sample from photobleaching. The reference detector looks at a fraction of the light exiting the excitation monochromator to correct for the lamp response, if desired.</p>
Excitation scan	<p>Shows the spectral distribution of light absorbed by the sample. To acquire an excitation scan, the excitation monochromator scans a selected spectral region while the emission monochromator remains</p>



	at a fixed wavelength.
Excited state ( $S_1$ )	The energy level to which an electron in the ground level of a molecule is raised after the absorption of a photon of a particular wavelength. Subsequently, fluorescence occurs, if the molecule returns to the ground state via a radiative transfer from the $S_1$ state to the ground state.
Experiment file	A file that contains specific information on the experimental setup for an acquisition defined in <b>Experiment Setup</b> . This file is saved with a default *.EXP extension. In addition to basic scan parameters, this file saves system defaults (such as slit units), and some accessory settings for the acquisition. Each acquisition type in the <b>Fluorescence Experiment Menu</b> has its own default experiment file (e.g., Dfl tEm1 .xml is the default emission-scan definition). Use experiment files to archive scan settings for acquisitions that are performed routinely.
Extrinsic fluorescence	Inherent fluorescence of probes used to study non-fluorescent molecules.
Filter	An optical element that is used to select certain wavelengths of light. Types of filters include high-pass, low-pass, bandpass, and neutral density.
Flash lamp	A lamp that provides pulsed-light output to excite a sample. Can be either “free running” or “gated.”
Fluorescence	The emission of light during the transition of electrons from the excited singlet state to the ground state from molecules originally excited by the absorption of light. Fluorescence typically occurs within $\sim 10^{-9}$ seconds.
Fluorescence lifetime ( $\tau$ )	The average length of time that a molecule remains in the excited state before returning to the ground state.
Fluorophore (fluorescent probe)	A molecule or compound that has a known fluorescence response. These probes have various sensitive areas depending on the peak excitation and emission wavelengths and their fluorescence lifetimes. Fluorophores are used to provide information on concentration, size, shape, and binding, in a particular medium. Good fluorophores are stable over wide pH and temperature ranges.
Front-face detection	A mode of detection in which fluorescence is collected off the front surface of the sample. Front-face detection usually is selected for samples such as powders, thin films, pellets, cells on a cover-slip, and solids.

Grating	Optical element in the monochromator, consisting of finely scribed grooves that disperse white light into a spectrum.
Ground state ( $S_0$ )	The lowest energy level in a molecule. For fluorescence to occur, a molecule absorbs a photon of light, thereby exciting it to the $S_1$ level. A fluorescence emission occurs during a transition from an excited state $S_1$ to the ground state $S_0$ .
High-pass filter	Optical component that passes light of a higher wavelength.
Increment	The spacing between adjacent measurement points in an acquisition. Typically, increments take the form of wavelength (nm) or time (s or ms).
Inner-filter effect	The scattering of the excitation or emission beam from a concentrated sample by the individual molecules in the sample. This reduces the apparent signal intensity from the sample creating an artifact in the data. For this reason, we recommend using concentrations of <0.05 OD in a 1-cm-pathlength cell. Samples measured in higher concentrations should be measured in a reduced-path-length cell, or in front-face mode.
Integration time	The amount of time that each data point is collected from the detector(s), specified in either seconds or milliseconds. Longer integration times can help improve the signal-to-noise ratio for a measurement, while shorter integration times reduce the amount of time required for a scan.
Internal conversion	Electronic transitions within an excited molecule that do not result in emission. Also called a “non-radiative transition”, this usually involves changes in vibrational levels.
Intersystem crossing	The electronic transition from the excited singlet state to the excited triplet state before returning to the ground state. This transition involves a change of spin that is quantum-mechanically forbidden, giving a much longer timescale than fluorescence. This transition causes phosphorescence on the timescale of microseconds to seconds.
Intrinsic fluorescence	The natural fluorescent properties of molecules.
Jablonski (energy) diagram	A diagram that illustrates various energy levels and electronic transitions available in a particular molecule. Possible paths for fluorescence, phosphorescence, and non-radiative transfers are shown on this diagram, along with the various vibrational sub-levels available around each energy level.
Laser	A monochromatic light source that provides high excitation intensity.

Linearity	(1) Signal response; the desired response from a light detector is a linear relationship. For example, when detector response is linear, if the light intensity doubles, the detected signal also doubles. Most detectors exhibit non-linear behavior near saturation. On the FluoroMax <sup>®</sup> Plus, the emission photomultiplier tube is linear up to 2 million counts per second. Above this, pulse pileup occurs on the photon-counting module (when multiple photons are counted as one). This results in a non-linear response, and the detector efficiency drops. (2) Spectral positioning accuracy or tracking error of a spectrometer drive mechanism. See Spectral Calibration.
Low-pass filter	Optical component that passes light of a lower wavelength.
Luminescence	The emission of light from matter excited from a variety of processes, resulting in an electronic transition within the molecule to a lower energy state. See also: Bioluminescence, Chemiluminescence, Fluorescence.
MCD shutter	Multi-channel device shutter. The Uniblitz <sup>®</sup> shutter is used for its rapid cycle time.
Mercury lamp	Light source that emits discrete, narrow lines as opposed to a continuum. A mercury lamp can be used to check the monochromator's calibration.
Mirror-image rule	When the emission profile appears to be the mirror image of the absorption spectrum.
Molar extinction coefficient ( $\epsilon$ )	The absorptivity of a particular substance, in $M^{-1} \text{ cm}^{-1}$ .
Monochromator	The component in a spectrofluorometer that is scanned to provide the excitation and emission spectra. Monochromators are chosen for stray-light rejection, resolution, and throughput.
Multifile	The three-dimensional acquisition datafiles collected by the software using matrix scans or temperature scans, stored as an array of datafiles. A multifile is still stored with an .SPC extension. Multifiles may be used in their entirety in FluorEssence <sup>™</sup> as 3D files, or they may be split up into individual two-dimensional spectra using multifile utilities.
Multigroup	This special software allows a time-based scan to be acquired across more than one excitation/emission pair. Up to 16 different wavelength pairs may be entered for a multigroup scan. The spectrofluorometers will cycle through each pair, integrating for the

	specified time, before moving on to the next point. Use Multigroup software for measuring ratiometric probes (such as Fura-2 or BCECF).
Neutral-density filter	An optical element that absorbs a significant fraction of the incident light. These filters usually are characterized by their optical density, on a logarithmic scale. For example, a filter with OD = 1 transmits 10% of the incident light. Ideally, these filters absorb all wavelengths equally. See also Absorbance.
Optical density	A synonym of <i>absorbance</i> . See Absorbance.
Optical-density effects (Inner-filter effect)	Fluorescence intensities are proportional to the concentration over a limited range of optical densities. High optical densities can distort the emission spectra as well as the apparent intensities. See also Inner-filter effect.
Phosphorescence	The emission of light or other electromagnetic radiation during the transition of electrons from the triplet state to the ground state. Phosphorescence is generally red-shifted relative to fluorescence and occurs within $\sim 10^{-6}$ to $\sim 1$ second. To enhance phosphorescence, samples often are frozen at liquid-nitrogen temperature (77 K).
Photobleaching	The reduction in fluorescence from a photosensitive sample overly exposed to excitation light. Not all samples photobleach, but if so, take care to keep the sample out of room light, and to use the excitation shutter and its photobleach modes on the spectrofluorometer to protect the sample from excessive exposure.
Photoelectron	An electron released through the interaction of a photon with the active element of a detector. The photoelectron may be released either from a junction to the conduction band of a solid-state detector, or from the photocathode to the vacuum in a PMT. A photoelectron is indistinguishable from other electrons in any electrical circuit.
Photon-counting detection	A method of detection used primarily with photomultiplier tubes, in which discrete current pulses from the tube are integrated and “counted up”. With this method, noise inherent to the detector can be minimized, resulting in much more sensitive detection than used in traditional current- or voltage-detection modules. A limit to photon-counting is when pulse pileup occurs, that is, when two counts occur too fast for the module to count them individually. This creates nonlinearity in the detector at high signal-levels.
Polarization ( <i>P</i> )	A measurement of the fluorescence polarization of a sample de-

	defined as the linear polarizer's component's intensity divided by the natural light intensity. The measurement of polarization provides insight into molecular size, shape, and the environment surrounding the molecule. Another unit, called millipolarization ( $mP$ ), is used to monitor small changes in polarization. $P = mP \times 1000$ .
Pulse-sampling method	A technique for measuring fluorescence lifetimes, in which an initial population of fluorophores is excited by infinitely short pulses of light. An advantage of this technique is the direct recording of time-resolved emission spectra.
Quantum yield (Fluorescence quantum yield)	The efficiency of the absorption of a photon to be emitted (fluoresced). Quantum yields typically are expressed as percents. The fluorescence quantum yield is the percentage of photons absorbed that actually leads to fluorescence. This number is reduced by scattering, quenching, internal conversion, and non-radiative effects, along with several other specialized processes. Measurements of quantum yields usually require the comparison of a sample with a known fluorophore such as Rhodamine-B or Ru(BPY) <sub>3</sub> .
Quenching	Reduction in the fluorescence intensity of a sample by a variety of chemical or environmental influences. Quenching may be static, dynamic, or collisional in nature.
Raman scattering	Scattering caused by vibrational and rotational transitions. Raman bands generally appear red-shifted relative to the incident electromagnetic radiation. The primary characteristic of Raman scatter is that the difference in energy between the Raman peak and the incident radiation is constant in energy units ( $\text{cm}^{-1}$ ).
Rayleigh scattering	Light scattering from particles whose dimensions are much smaller than the wavelength of incident light. Rayleigh-scattered light is of the same energy as the incident light. The scattered radiation's intensity is inversely proportional to the 4 <sup>th</sup> power of the wavelength of incident radiation.
Real Time Control	The FluorEssence <sup>™</sup> software application that gives the user full control of the system in real-time, in order to optimize the system setup for a particular measurement. Use Real Time Control to find the optimal slit widths for sample measurements, or to check that the excitation beam is striking the sample properly.
Reference detector	The detector used to monitor the output of the xenon lamp. A silicon photodiode with enhanced-UV response is used for the FluoroMax <sup>®</sup> Plus, and is connected to input channel R. Use S/R to correct for the xenon-lamp response during an excitation scan.
Resolution	The ability to separate two closely spaced peaks. Resolution can be improved by decreasing the bandpass and the increment (step size).

Right-angle detection	Collection of fluorescence at 90° to the incident radiation. Right-angle detection typically is selected for dilute and clear solutions.
Sample changer (automated)	An automated accessory that automatically positions up to four cuvettes held in the sample compartment. Use this accessory to run up to four samples at one time for a small assay, or to run blanks with the samples simultaneously. Automated sample changers are thermostatted and possess magnetic stirrers.
Saturation	The effect of having too much signal incident on a particular detector. Saturated detectors give an erroneous result and no longer show any response for small changes in signal. In some cases, saturation can damage a detector's performance, so avoid saturation whenever possible. The R928P photomultiplier tube used on the FluoroMax <sup>®</sup> Plus saturates at $1 \times 10^7$ cps.
Scatter	A combination of Raman, Rayleigh, and Rayleigh-Tyndall scattering, which can distort fluorescence spectra with respect to intensities and wavelengths.
Signal channel	See: Acquisition modes.
Signal photomultiplier	Detector used to measure excitation and fluorescence from the sample, operated in photon-counting mode to provide the highest sensitivity. Different detectors can be used to optimize different wavelength regions.
Signal-to-noise ratio ( <i>S/N</i> )	The measurement of the signal observed divided by the noise component seen in that signal. Generally, the better the <i>S/N</i> is, the better the measurement is. This is accomplished by using photon-counting detection with the proper high-voltage bias for improved sensitivity during fluorescence measurements. The user then optimizes the sample signal to the higher area of the linear range for the detector, typically between 100 000 and 2 000 000 cps. Next, dark offsets or blank subtraction may be used to improve the <i>S/N</i> . Finally, increasing the integration time or repeating the same scan several times can improve the signal to noise. For specifications, signal-to-noise may be represented as signal to peak-to-peak noise, or signal-to-noise at first standard deviation (FSD).
Single Point	The FluorEssence <sup>™</sup> scan-type designed for performing single-point measurements at discrete wavelength pairs. The data are acquired as single points at a user-defined set of excitation-emission wavelength pairs for a user-defined number of samples. These data are displayed in either spreadsheet format, or in a plot. This application is for MicroMax or FluoroMax <sup>®</sup> Plus users who routinely perform assays on a large number of samples.

Singlet state	The spin-paired ground or excited state. The process of absorption generally produces the first excited singlet state, which takes time to fluoresce, and may undergo intersystem crossing to form a triplet state.
Spectral calibration	The accuracy of a monochromator with respect to its wavelength alignment. This is a measure of the monochromator being at the correct wavelength when it is set there. Monochromators are traditionally calibrated using line-spectra sources, such as mercury lamps. Spectrofluorometers may be calibrated by performing two scans, one of the source, and one of a standard (such as water) to calibrate all of the monochromators. For HORIBA Scientific spectrofluorometers, the xenon-lamp scan is performed on the excitation with the 467.1-nm peak assigned as such in the software. The water Raman band is scanned with 350-nm excitation, and the 397-nm peak is assigned as such in the software for the emission monochromators.
Spectral correction	The removal of the wavelength sensitivity of detectors, optics, sources, and backgrounds from the spectrum taken on a sample. When spectral correction has been properly performed, the true theoretical spectra from a sample should be all that remains. Spectral correction is accomplished with a variety of options on HORIBA Scientific spectrofluorometers. Excitation and emission correction factor files are provided to remove the wavelength sensitivity of detectors and their optics. The reference detector is present to remove the lamp and excitation optics response. Blank subtraction and dark offset are used to remove background levels and responses.
Spectral response	All detectors have a higher sensitivity to some wavelengths than to others. The spectral response of a detector is often expressed graphically in a plot of responsivity versus wavelength.
Spectrofluorometer	An analytical instrument used to measure the fluorescence properties of a molecule or substance. The device consists of at least two monochromators, a source, a sample compartment and detection electronics. The instruments may be scanned on the excitation, emission or both to provide insight on the characteristics of the sample being studied. Newer spectrofluorometers provide many more automated options, including polarization, temperature, titer plates, pressure, and many more. Today, these instruments are computer-controlled, allowing easy control of assays and complex experiments.
Stokes shift	Generally, the energy-difference between the absorption peak of lowest energy and the fluorescence peak of maximum energy

Synchronous scan	Scan type characterizing the overlap between the excitation and emission. The excitation and emission spectrometers are scanned at the same time, with a constant offset specified in either nanometers (wavelength units) or in $\text{cm}^{-1}$ (energy units).
TCSPC	<b>T</b> ime- <b>c</b> orrelated <b>s</b> ingle- <b>p</b> hoton <b>c</b> ounting. Technique in which the sample is excited by a pulsed source, and the sample's fluorescence is collected over the course of many pulses. The arriving photons are timed after the excitation. Gradually a decay curve is built up and the sample's fluorescent lifetime is calculated.
Technical spectrum	A spectrum acquired on research instrumentation with instrumental bias remaining in the measurement. This spectrum must undergo proper spectral correction in order to match the theoretical spectrum. HORIBA Scientific spectrofluorometers offer various methods for such correction, including spectral correction, dark offset, blank subtraction, and others.
Temperature scan	A FluorEssence™ Kinetics scan-definition that consists of a particular scan made across a user-defined temperature range. This scan may be used to monitor a sample's temperature response, or, more specifically, to perform a melting curve for a sample. Temperature scans require an automated bath compatible with FluorEssence™ to be attached to the spectrofluorometer system along with a thermostatable sample mount.
Throughput	The amount of light that passes through the spectrofluorometer for a particular measurement. The throughput usually is measured as the counts per second measured on the water Raman band at 350-nm excitation with 5-nm bandpass. As bandpass increases, so does the throughput. Like bandpass, throughput has an inverse relationship with resolution. When the throughput is increased, the resolution decreases.
Time-based scan	Scan type in which the sample signal is monitored as a function of time, while both the excitation and the emission spectrometers remain at fixed wavelengths. Time-based data are used to monitor enzyme kinetics, dual-wavelength measurements, and determine reaction-rate constants.
Total luminescence spectroscopy (TLS)	Spectroscopy devoted to monitoring changes to the entire excitation/emission matrix of luminescence on a sample. This discipline is best applied to fast kinetics measurements of samples during reactions, temperature curves, or changes in other parameters.
Transmission	Light that passes through a sample without being absorbed, scattered, or reflected. Transmission is usually measured as a percentage of the incident light at a certain wavelength.



Triplet state ( $T_1$ )	The spin-paired ground or excited state formed from the excited singlet state, in which electrons are unpaired. The triplet state gives rise to phosphorescence.
Tyndall scattering	Scatter that occurs from small particles in colloidal suspensions.
Variable time kinetics	A special measurement menu in the Single Point experiment type. The user defines measurements that occur at specific times, for specific durations, and with different integration times. Those measuring assays can do the actual measurements at the desired times. See the FluorEssence <sup>™</sup> on-line help for more information.
Vibrational states	Sublevels within an electronic energy level resulting from various types of motion of the atoms in a molecule. Transition between these states at a particular energy level does not involve a large change in energy, and typically is a non-radiative transition. In larger electronic transitions such as fluorescence, a molecule drops from the lowest vibrational level of the excited state to the highest vibrational level of the ground state. This emission is termed the Stokes shift between the $S_1$ and ground states.
Xenon lamp	Lamp that produces a continuum of light from the ultraviolet to the near-infrared for sample excitation.
Xenon-lamp scan	A profile of the lamp output as a function of wavelength. The lamp scan is acquired using the reference detector while scanning the excitation spectrometer. The maximum xenon-lamp peak at 467 nm can be used to determine proper calibration of the excitation spectrometer.



# 14 : Bibliography

- P.M. Bayley and R.E. Dale, *Spectroscopy and the Dynamics of Molecular Biological Systems*, Academic Press, London, 1985.
- R.S. Becker, *Theory and Interpretation of Fluorescence and Phosphorescence*, Wiley-Interscience, New York, 1969.
- I.B. Berlman, *Handbook of Fluorescence Spectra in Aromatic Molecules*, 2nd ed., Vols. I & II, Academic Press, New York, 1971.
- C.R. Cantor and P.R. Schimmel, *Biophysical Chemistry: Techniques for the Study of Biological Structure and Function*, Vols. 1 & 2, W.H. Freeman, New York, 1980 & 1990.
- M. Chalfie and S. Kain, *Green Fluorescent Protein: Properties, Applications, and Protocols (Methods of Biochemical Analysis)*, 2<sup>nd</sup> ed., Jossey-Bass, New York, 2005.
- R.F. Chen, *et al.*, *Biochemical Fluorescence: Concepts*, Vol. I & II, 1964 & 1970.
- J.N. Demas, *Excited State Lifetime Measurements*, Academic Press, New York, 1983.
- Enrico Gratton, David M. Jameson, and Robert D. Hall, "Multifrequency Phase and Modulation Fluorometry," *Ann. Rev. Biophys. Bioeng.* **13**, 105–124 (1984).
- G.G. Guilbault, ed., *Fluorescence—Theory, Instrumentation and Practice*, Marcel Dekker, New York, 1967.
- \_\_\_\_\_, *Practical Fluorescence: Theory, Methods and Techniques*, 2<sup>nd</sup> ed., Marcel Dekker, 1990.
- \_\_\_\_\_, "Molecular Fluorescence Spectroscopy," *Anal. Chem.* **8**, 71–205 (1977).
- D.M. Hercules, ed., *Fluorescence and Phosphorescence Analysis*, Wiley-Interscience, New York, 1966.
- J.D. Ingle and S.R. Couch, *Spectrochemical Analysis*, Prentice-Hall, Englewood Cliffs, NJ, 1988.
- F.H. Johnson, *The Luminescence of Biological Systems*, Amer. Assoc. Adv. Sci., Washington, D.C., 1955.
- S.V. Konev, *Fluorescence and Phosphorescence of Proteins and Nucleic Acids*, Plenum Press, New York, 1967.
- M.A. Konstantinova-Schlezing, ed. *Fluorometric Analysis*, Davis Publishing Co., New York, 1965.
- Joseph R. Lakowicz, *Principles of Fluorescence Spectroscopy*, 3<sup>rd</sup> ed., Springer, New York, 2006.
- \_\_\_\_\_, ed., *Topics in Fluorescence Spectroscopy*, Vols. 1–5, Plenum Press, New York, 1991–1998.
- \_\_\_\_\_, Badri P. Melinal, Enrico Gratton, "Recent Developments in Frequency-Domain Fluorometry," *Anal. Instr.*, **14** (314), 193–223 (1985).
- \_\_\_\_\_, S. Soper, and R. Thompson, *Advances in Fluorescence Sensing Technology IV*, SPIE Proc. Series, Vol. 3602 (1999).

- W.T. Mason, ed., *Fluorescent and Luminescent Probes for Biological Activity: A Practical Guide to Technology for Quantitative Real-Time Analysis*, 2<sup>nd</sup> ed., Academic Press–Harcourt Brace & Co., 1999.
- W.H. Melhuish and M. Zander, “Nomenclature, Symbols, Units and Their Usage in Spectrochemical Analysis VI: Molecular Luminescence Spectroscopy,” *Pure App. Chem.*, **53**, 1953 (1981).
- J.N. Miller, ed., *Standardization & Fluorescence Spectrometry: Techniques in Visible and Ultraviolet Spectrometry*, Vol. 2, Chapman and Hall, 1981.
- W.G. Richards and P.R. Scott, *Structure and Spectra of Molecules*, John Wiley & Sons, 1985.
- A. Schillen, *et al.*, *Luminescence of Organic Substances*, Hellwege Verlag, Berlin, 1967.
- S.G. Schulman, ed., *Molecular Luminescence Spectroscopy: Methods and Applications*, Vols. 1–3, Wiley-Interscience, New York, 1985–1993.
- A. Sharma and S. Schulman, *Introduction to Fluorescence Spectroscopy*, Wiley Interscience, New York, 1999.
- D.A. Skoog, F.J. Holler, and T.A. Nieman, *Principles of Instrumental Analysis*, 5<sup>th</sup> ed., Brooks Cole, New York, 1998.
- N.J. Turro, V. Ramamurthy, and J.C. Scaiano, *Modern Molecular Photochemistry of Organic Molecules*, University Science Books, New York, 2006.
- K. Van Dyke, *Bioluminescence and Chemiluminescence: Instruments and Applications*, Vol. 1, CRC Press, Boca Raton, FL, 1985.
- T. Vo-Dinh, *Room Temperature Phosphorimetry for Chemical Analysis*, Wiley-Interscience, New York, 1984.
- I.M. Warner and L.B. McGown, ed., *Advances in Multidimensional Luminescence*, Vols. 1 & 2, JAI Press, Greenwich, CT, 1991–1993.
- E.L. Wehry, ed., *Modern Fluorescence Spectroscopy*, Vol. 1–4, Plenum Press, New York, 1975–1981.
- C.E. White and R.J. Argauer, *Fluorescence Analysis: A Practical Approach*, Marcel Dekker, New York, 1970.
- J.D. Winefordner, S.G. Schulman, and T.C. O’Haver, *Luminescence Spectrometry in Analytical Chemistry*, Wiley-Interscience, New York, 1972.

In addition, the following journals may prove useful:

*Analytical Chemistry*

*Biophysics and Biochemistry*

*Journal of Fluorescence*

*Nanotechnology Letters*

# 15 : CE Compliance Information

## Declaration of Conformity

**Manufacturer:** HORIBA Instruments Inc.

**Address:** 3880 Park Avenue  
Edison, NJ 08820  
USA

<b>Product Name:</b>	FluoroMax	
<b>Model#:</b>	FluoroMax 4	FluoroMax 4C
	FluoroMax 4P	FluoroMax 4CP
	FluoroMax 4NIR	FluoroMax 4CNIR
	FluoroMax 4PNIR	FluoroMax 4CPNIR
	FluoroMax Plus	FluoroMax PlusC
	FluoroMax PlusP	FluoroMax Plus CP

Conforms to the following Standards:

**Safety:** EN 61010-1: 2010

**EMC:** EN 61326-1:2013 (EMC, general requirements)

## Supplementary Information

The product herewith complies with the requirements of the Low Voltage Directive 2006/95/EC and the EMC Directive 2004/108/EC.

The CE marking has been affixed on the device according to Article 8 of the EMC Directive 2004/108/EC.

The technical file and documentation are on file with HORIBA SCIENTIFIC.

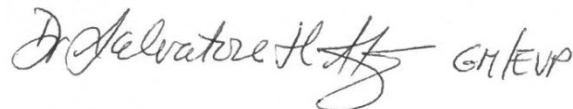

**Dr. Salvatore H. Atzeni**  
General Manager and Executive Vice President  
Chief Technology Officer

**HORIBA Instruments Incorporated**

*HORIBA Scientific*

Edison, NJ 08820

USA

May 28, 2015

## **Applicable CE Compliance Tests and Standards**

---

<b>Test</b>	<b>Standards</b>
Emissions, Radiated/Conducted	EN 55011:2009/A1:2010
Radiated Immunity	EN 61000-4-3: (2006) + A1(2008) + A2(2010)
Conducted Immunity	EN 61000-4-6: 2009
Electrical Fast Transients	EN 61000-4-4: (2004) + A1 (2010)
Electrostatic Discharge	EN 61000-4-2: 2009
Voltage Interruptions	EN 61000-4-11: 2004
Surge Immunity	EN 61000-4-5: 2006
Magnetic Field Immunity	EN 61000-4-8: 2010
Harmonics	EN 61000-3-2: 2014
Flicker	EN 61000-3-3: 2013
Safety	EN 61010-1: 2010

# 16 : Index

## **Key to the entries:**

Times New Roman font.....	subject or keyword
Arial font.....	command, menu choice, or data-entry field
Arial Condensed Bold font	dialog box
Courier New font.....	file name or extension

---

## **1**

15-pin connector .....2-5, 6-2, 9-13  
1905-OFB .....12-20

---

## **2**

2D Intensity Map button .....4-16–17

---

## **3**

3D Scan to 3D Profile button.....4-7

---

## **A**

About FluorEssence window .....7-10  
About FluorEssence.....7-10  
absorbance .....12-30  
Accessories icon 10-4, 10-7, 10-10, 10-14–15  
Accumulations field.....5-9  
Acquire / View tab.....4-22  
Add Multiples button .....4-13  
Add >> button ..... 5-17, 10-17  
Adjacent Averaging .....5-12  
Advanced Setup ..... 5-15, 8-10, 8-12

Advanced... button.....10-6–7, 10-10  
Alconox<sup>®</sup> ..... 5-1  
Allen key ..... 1-5, 6-1, 6-3, 6-5, 6-7, 6-9, 9-13  
Analysis .....5-12, 5-18, 8-4, 8-7, 9-10  
anisotropy. 10-1–4, 10-6, 10-8–10, 10-12–13,  
10-16, 10-18  
Anisotropy ..... 5-5  
Anisotropy scan.....10-6, 10-9  
anthracene.....4-27  
Arbitrary Line button.....4-8  
Auto Run Previous Experiment button ..... 4-5  
autopolarizers ..... 10-10, 10-14–15, 10-20  
Autotitration Injector ..... 12-19

---

## **B**

bandpass 2-3–4, 3-5, 3-11, 3-13, 5-7–8, 5-11,  
6-9, 7-2, 10-2, 11-2  
batch job .....4-9–10  
biological samples .....5-3, 5-11  
Blank .....4-13  
blank scan .....5-14  
blank subtraction .....5-14  
blazing .....2-3  
Browse button.....4-3  
Browse for experiment files to >> Add  
button.....4-9  
B(Y) column .....8-8

---

## **C**

cable.1-5, 1-7, 1-9, 6-2, 6-7, 7-2–3, 8-5, 9-13,  
9-16, 10-20, 12-27, 12-29–30  
Calibrate Excitation 1 button ..... 3-9  
Calibrate window ..... 3-9  
calibrated lamp ..... 8-2  
calibration curve .....4-12, 4-14–15  
Calibration Curve Parameters window  
.....4-15  
Cancel button ..... 3-9, 10-9, 10-12

capillary cell..... 5-2  
 caution notice..... 0-5  
 CE compliance..... 0-12  
 CE Compliance Tests and Standards..... 15-2  
 Clear all button..... 4-14  
 Collect ..... 5-15, 8-10, 8-12  
 colloidal silica..... 10-6  
 Comments field..... 4-9  
 Concentration column..... 4-13  
 Connect Config button..... 4-21  
 console window ..... 6-13  
 constant-wavelength analysis..... 10-16  
 Continue button..... 10-8, 10-11  
 Continuous checkbox..... 4-11  
 Copy to Clipboard button ..... 4-22  
 Correction checkbox..... 5-16, 8-10  
 Correction Factor Kit ..... 12-6  
 correction factors . 2-5, 5-14–16, 5-18, 8-1–5,  
 8-8, 8-10, 8-12, 10-4  
 correlation ..... 4-15  
 coverslips ..... 5-2  
 Create/Use Calibration Curve from CWA  
 Data button..... 4-12, 4-15  
 Crossed Lines button..... 4-8  
 current-acquisition module ..... 2-2  
 cursor button ..... 3-6  
 Cursor function ..... 3-6  
 curve-fitting..... 9-7  
 Cut-On Filter..... 12-9–10  
 Cut-On Filter Holder..... 12-10  
 cuvette .... 3-10, 5-1–2, 6-8, 7-2, 7-7–8, 10-20,  
 12-12, 12-14, 12-16, 12-21  
 Czerny-Turner..... 2-3, 11-2

---

## D

danger to fingers notice..... 0-6, 1-6  
 dark counts ..... 2-5  
 dark noise ..... 10-20  
 dark offset ..... 5-14  
 Dark Offset checkbox ..... 7-2  
 Data Export area..... 4-22  
 DataStation software..... 4-18  
 Decay by Delay..... 9-3, 9-9  
 Decay by Window..... 9-3, 9-9  
 Declaration of Conformity ..... 15-1  
 de-ionized water..... 3-10, 5-1, 6-8, 7-7  
 delay after flash..... 11-3

Delay after flash ..... 9-8–9  
 Delay before executing field..... 4-10  
 Delay before first field..... 4-10  
 Delay between each field..... 4-10  
 Delay between each repeat list field .. 4-10  
 Delete button ..... 4-9  
 Delete rows button..... 4-14  
 detector ... 2-1–5, 3-5, 3-11, 3-13, 4-24–26, 4-  
 28, 5-5–6, 5-8, 5-14, 5-16, 6-11, 7-1, 8-1–  
 2, 8-11–12, 9-1–2, 9-4, 11-1–2, 12-30  
 Detector ..... 5-16  
 detector checkbox ..... 4-21  
 Detector column..... 8-11  
 Detectors area ..... 4-21  
 Detectors icon 5-6, 5-9, 5-16, 7-11, 8-12, 9-9  
 Dewar flask..... 12-3  
 dimensions ..... 11-2  
 disclaimer ..... 0-3  
 dispersion..... 2-4, 11-2  
 Display Options icon ..... 4-6  
 dissolved solids..... 5-3  
 DM303..... 12-30  
 Down button..... 4-9  
 dry nitrogen ..... 12-32  
 Dual-Position Thermostatted Cell Holder . 12-  
 13

---

## E

electric shock notice ..... 0-6  
 electrical requirements..... 1-4  
 elliptical mirror ..... 2-2  
 Emission..... 3-11, 4-23, 9-3, 9-6, 9-8  
 emission scan..... 4-2, 4-23, 4-26, 8-6  
 Empty..... 4-13  
 Emulate radio button ..... 1-10  
 emulation ..... 1-9  
 Enable checkbox ..... 4-13  
 Enter key ..... 3-9  
 environmental requirements ..... 1-3  
 ethylene glycol..... 12-11, 12-13, 12-15  
 EuCl<sub>3</sub>..... 9-7–9  
 excessive humidity notice..... 0-6  
 Excitation..... 3-4, 4-25, 9-3, 9-8  
 excitation scan ..... 4-23  
 excitation-emission matrix ..... 4-7  
 Execution List ..... 4-9–10



Expand button .....3-6  
 Experiment File field ..... 4-3, 4-24  
 Experiment File name.....4-26  
 Experiment Menu button ..1-9, 3-4, 3-10, 4-2,  
 4-12, 4-23, 4-25, 5-5  
 Experiment Setup window...3-7, 4-2, 4-4,  
 4-6, 4-12, 4-23, 4-25, 5-5, 5-8–10, 5-16, 7-  
 11, 8-10, 8-12, 9-8–9, 10-4, 10-7, 10-10,  
 10-15–16  
 Experiment Type window 4-2, 4-23, 4-25,  
 3-4, 3-10, 5-5, 10-16  
 Experiment window .....3-9  
 explosion notice ..... 0-5, 0-10  
 Export.....8-8  
 extreme cold notice.....0-5

---

**F**

F-3004 .....12-21  
 F-3005 .....12-19  
 F-3006 .....12-19  
 F-3011 .....12-4  
 F-3012 .....12-4  
 F-3023 .....12-7  
 F-3025 .....12-27  
 F-3025M .....12-27  
 F-3026 ..... 8-2, 8-5, 12-6  
 F-3029 ..... 12-2, 12-25  
 F-3031 .....12-30  
 F4-3030 .....12-29  
 F4-3030-220 .....12-29  
 face-shield .....0-7  
 FFT Filtering.....5-12  
 Fiber Optic Bundles ..... 12-8, 12-22  
 Fiber Optic Mount .....12-8  
 File column .....8-12  
 File menu .....8-8  
 File name field ..... 4-6, 4-9  
 filter.....5-4, 7-2, 8-2, 12-9–10  
 Filter Holder.....12-9  
 firmware.....6-13–16  
 Fit .....9-10  
 fit equation .....4-15  
 FL-1013 .....12-3  
 FL4-1011 .....12-11  
 FL4-1012 .....12-13

FL4-1015 ..... 12-24  
 FL4-1027 ..... 12-15  
 Flash count .....9-4, 9-8  
 flash lamp ..... 2-2–3, 9-2, 9-11–12, 9-15–16  
 flash-lamp replacement ..... 9-11  
 flip-mirror ..... 9-12  
 Fluorescence Main Experiment Menu  
 .1-10, 3-4, 3-10, 4-2, 4-12, 4-23, 4-25, 5-5,  
 9-5, 9-8, 10-15–16  
 FluorEssence icon..... 1-9  
 FluorEssence window.. 1-9, 3-2, 4-19, 5-18  
 FluorEssence™ .0-1, 1-5, 1-7, 1-9–10, 2-3–6,  
 3-2, 4-1, 4-14, 4-19–20, 4-22, 5-8–11, 5-  
 14, 7-1, 7-3, 7-9–10, 8-5, 8-10, 9-3–5, 9-7–  
 8, 9-12, 10-7, 10-10, 10-13–14, 11-4, 12-6,  
 12-22  
 FluoroMax4\_1.0.iic.....6-15  
 FM-2002 .....12-26  
 FM-2003 ..... 12-11, 12-13, 12-15  
 FM-2007 .....12-32  
 FM-2008 .....12-9–10  
 FM4-2000 .....12-23  
 FM4-2015 ..... 11-3, 12-28  
 FM4-2016 .....12-28  
 FM4-3000 .....12-8  
 Formulas list ..... 4-28–29  
 Formulas table.....5-17, 10-17  
 Four-Position Thermostatted Cell Holder . 12-  
 11  
 Fura-2 .....4-1  
 fused silica .....12-3–5  
 fuses .....1-4, 11-3

---

**G**

G factor ..... 5-5–6, 10-2–3, 10-17  
 G Factor checkbox .....5-6, 10-17  
 gearbox .....2-3  
 glycogen ..... 10-6, 10-8, 10-10–11, 10-20  
 Graph field.....5-19  
 grating.....2-3, 5-14, 8-2, 11-2  
 Grating column .....8-11

---

**H**

heavy lifting notice.....0-6, 1-6

help..... 5-9–10, 5-14, 9-4  
 Help..... 7-9  
 highly opaque samples..... 5-2  
 HJY\_normalize window..... 8-4, 8-7  
 HJY\_simple\_math window..... 8-7  
 HJY Tools..... 5-18  
 HJY\_simple\_math window..... 5-18  
 HJYUpdate subdirectory..... 6-13  
 HJYUpdate2.4.exe..... 6-13  
 host computer.. 0-1, 1-4–5, 1-7–9, 2-1–2, 2-6,  
 3-2, 6-2, 6-13, 9-12, 10-20, 11-1–2, 11-4,  
 12-22–23  
 hot equipment notice..... 0-6  
 HPLC Flow Cell..... 12-4

---

**I**

Inc field..... 5-10  
 Initial Delay..... 9-2–4, 9-6  
 Injector Port..... 12-24  
 inner-filter effect..... 10-20, 12-30  
 Input drop-down menu..... 5-12  
 Insert button..... 5-16, 8-11  
 Insert row button..... 4-14  
 Installed Components window..... 7-10  
 instrument configuration... 4-21, 5-15, 9-8, 9-  
 12, 10-14, 10-20, 12-30  
 Instrument Correction Files area 5-16, 8-11  
 Instrument Correction Files icon 5-16, 8-11  
 integrating sphere..... 12-6, 12-25  
 integration time 3-5, 3-11, 3-13, 4-21, 4-24, 5-  
 7–8, 6-9, 8-6, 9-2, 11-2  
 Integration Time field..... 9-8  
 intense light notice..... 0-5, 0-10  
 Intermediate Display 3-5, 3-12, 4-3, 4-5–  
 6  
 IR sensor..... 7-3  
 IRR..... 8-3–4  
 irradi..... 8-7  
 irradi2..... 8-8  
 irradiance..... 8-2–3

---

**J**

J1920..... 12-4  
 J1925..... 12-4  
 J1933..... 5-2, 12-17  
 J1939..... 12-9–10  
 J1950..... 12-8  
 J1955..... 12-4  
 J351697..... 1-5  
 J400906 board..... 2-6, 6-12  
 J400981..... 12-31  
 J53057..... 1-5  
 J650518..... 12-5  
 J650519..... 12-5  
 J810005..... 1-5  
 J980087..... 1-5  
 J98015..... 1-5  
 J98020..... 1-5  
 Janis cryostat..... 12-7  
 .jyb file..... 4-9

---

**K**

Keep Source Graphs checkbox..... 5-19  
 kinetics..... 10-13, 12-24, 12-27

---

**L**

lamp replacement..... 6-1  
 laser..... 10-1  
 Launch DataStation button..... 4-18  
 Legendre polynomial..... 10-3  
 leveling feet..... 1-6  
 L-format..... 10-3  
 Linear..... 4-15  
 linear range..... 2-5  
 liquid nitrogen..... 12-3, 12-7  
 Liquid Nitrogen Dewar Assembly..... 12-3  
 Load button..... 4-9  
 Lorentzian distribution..... 5-10  
 Ludox®..... <sup>10-6</sup>, 10-8, 10-10–11, 10-18, 10-20

---

**M**

magic-angle conditions..... 10-4  
 magnetic stirrer..... 2-5, 12-4–5, 12-11–16  
 maintenance..... 6-1

Make Overlay File button .....4-6  
 Material Safety Data Sheets.....0-3  
 Math Function.....5-19  
 Maximum Delay.....9-4  
 Maximum Sample Window .....9-4  
 maximum temperature fluctuation.....1-3  
 mcorrect . 5-14, 5-16, 5-18–19, 8-1–2, 8-4,  
 8-7, 8-10  
 methanol.....10-18  
 Method drop-down menu.....5-12  
 MgF<sub>2</sub> .....2-3  
 MicroMax .....1-4, 3-2, 4-2, 4-12  
 Micro Cell .....12-4  
 Micro Cell Adapter .....12-4  
 microliter sample cell.....12-5  
 MicroMax 384 .....12-22  
 microscope-mapping.....4-16  
 Microsense .....12-5  
 Microwell Plate Reader .....12-22  
 millipolarization.....10-3  
 Mono column .....8-11  
 monochromator 2-1–4, 2-6, 3-1, 3-3–8, 3-10–  
 12, 4-2, 4-21, 5-4, 5-11, 6-5, 6-9, 6-11–12,  
 7-1, 7-3, 7-8, 8-11, 9-2, 9-8–9, 10-6, 11-1–  
 2, 12-8–9, 12-17–18  
 monolayers.....5-2  
 Monos .....5-10  
 Monos / Detectors tab .....4-21  
 Monos icon.....3-8  
 MSDS.....0-3  
 Multigroup .....4-1, 4-20, 4-22, 11-4  
 Multigroup button .....4-20  
 Multigroup icon .....4-20  
 Multigroup window.....4-20  
 multiply.....5-19

---

**N**

N/A.....4-13  
 NanoLED .....11-3, 12-28  
 Next >> button 1-10, 3-11, 4-2, 4-23, 4-25, 5-  
 5, 10-16  
 nitric acid .....5-1  
 nitrogen gas.....12-21  
 Normalize .....8-8  
 Not Found.....1-10

---

**O**

OK button 1-10, 3-9, 4-3, 4-15, 5-12, 5-19, 7-  
 10, 8-12  
 Operand field.....5-19  
 optical layout .....2-2  
 Order.....4-15  
 Origin<sup>®</sup> 0-1, 4-3, 4-5, 4-19, 5-12–13, 7-10, 9-  
 5, 10-13  
 overlay file.....4-6

---

**P**

Peak Of Interest field.....3-9  
 Performance Test Report.....3-3  
 Phillips screwdriver .....6-1, 6-4, 9-14  
 Phos experiment .....9-5–6, 9-8  
 phosphorimeter ..0-1, 7-3, 9-1, 9-3–5, 9-8–10,  
 11-1  
 Phosphorimeter area .....9-8–9  
 phosphorimeter layout.....7-1  
 phosphorimeter scan.....4-2  
 photobleach .....2-4, 5-10  
 photodiode.....2-2, 2-4–5, 3-4, 11-2  
 photomultiplier tube .2-2, 2-5, 3-10, 3-12, 9-2  
 pipette .....12-5  
 POLAR . LOG .....10-10  
 polarization 10-1–4, 10-6, 10-9, 10-13, 10-16,  
 10-20  
 Polarization area .....5-6  
 polarization ratio.....10-6, 10-12, 10-19–20  
 polarizer....10-1, 10-3–5, 10-8, 10-10–11, 10-  
 13–15, 10-18–20, 12-23  
 Polarizer.....12-23  
 Polarizer Alignment window ..10-6–7, 10-  
 10  
 Polynomial .....4-15  
 Position Control field .....3-9  
 potassium bromide .....5-2  
 powder .....5-2, 5-4, 12-7, 12-17  
 power cord.....1-6, 6-2, 9-12, 9-13  
 power supply .2-2, 2-6, 6-2, 6-11, 7-1, 8-2, 9-  
 12, 12-6  
 power switch.....3-1, 3-2  
 Pre-scan button.....4-22  
 Preferences .....5-16, 8-11  
 Preferences area.....8-11

Previous Experiment button ..... 3-7, 4-4  
 Print Info button ..... 7-10  
 Profiles window ..... 4-7  
 Project Name window ..... 4-3  
 protective gloves ..... 0-6  
 pulsed xenon lamp ..... 11-1  
 purge port ..... 12-32

---

## Q

Quanta-φ ..... 12-25  
 quantum yield ..... 5-7, 8-1, 12-25  
 Quantum-Yield accessory ..... 12-25  
 Quartz Cuvette ..... 12-4  
 quartz window ..... 2-2

---

## R

R ..... 5-14, 5-16, 5-18  
 $\langle r \rangle$  ..... 10-3  
 R1c ..... 4-29  
 R928P ..... 2-5, 9-2, 11-2  
 Ratios area ..... 4-21  
 raw polarization ..... 10-3  
 Read this manual ..... 0-6  
 Real Time Control button ..... 4-11  
 Real Time Control window. 3-7, 3-9, 4-11,  
 5-8, 6-9, 7-1, 10-6, 10-14  
 Reduced Volume Sample Cell ..... 12-5  
 relative humidity ..... 1-3, 11-3  
 Remeasure Anisotropy Only utility .... 10-6  
 Reset to Mechanical Zero ..... 10-8, 10-11  
 resolution ..... 11-2  
 RoHS Declaration of Conformity ..... 0-13  
 RS-232 cable ..... 6-2, 9-13  
 RTC button ..... 3-7  
 Run button 3-5, 3-9, 3-12, 4-3-4, 4-10-11, 4-  
 14, 4-25-26, 10-17  
 Run JY Batch Experiments button ..... 4-9

---

## S

S ..... 4-24, 4-26, 5-16, 5-18  
 S/N ..... 3-13-14, 5-7-9  
 S/R ..... 4-26, 5-14

S/R checkbox ..... 4-21  
 S1c ..... 4-29  
 S1c/R1c ..... 4-29  
 safety goggles ..... 0-6  
 safety summary ..... 0-5  
 safety-training requirements ..... 0-9, 1-1  
 Sample Cell ..... 12-4  
 sample changer ..... 4-13, 6-12  
 sample compartment.. 2-2, 2-4, 3-4, 3-10, 4-3,  
 4-25, 6-3, 6-8, 8-6, 12-8-10, 12-21, 12-23-  
 26, 12-28, 12-30  
 Sample Compartment Accessory ... 12-11, 12-  
 13, 12-15  
 Sample Heater/Cooler Peltier Thermocouple  
 Drive ..... 12-21  
 sample platform ..... 2-5  
 sample preparation ..... 5-2  
 sample turret ..... 2-5, 7-1, 7-3  
 sample window ..... 11-3  
 Sample window ..... 9-2-4, 9-8  
 Save As window ..... 4-6  
 Save button ..... 4-6, 4-9  
 Save Curve window ..... 4-15  
 Save to File button ..... 4-22  
 Save To File... button ..... 7-10  
 Savitsky-Golay ..... 5-12  
 SC Auto radio button ..... 4-13  
 SC Manual radio button ..... 4-13  
 scan speed ..... 11-2  
 scattering ..... 7-2  
 scrambler plates ..... 10-4  
 second-order effects ..... 12-9-10  
 Select area ..... 7-11  
 Select Hardware Configuration  
 window ..... 1-10  
 sensitivity ..... 3-3, 3-13, 11-2  
 Service Department ... 1-1, 7-1, 7-3, 7-9, 7-11,  
 8-13, 10-19  
 Setup batch experiments window .... 4-9  
 shutter ..... 2-4, 6-9, 6-12, 7-1, 11-2  
 Shutter accessory ..... 12-26  
 Signal ..... 10-17  
 Signal Algebra area ..... 4-29, 5-16, 10-17  
 signal-to-noise ratio ..... 3-3, 3-13, 5-7  
 Simple Math... ..... 5-18

Simple Math Tool window .....8-4

Single Point .....4-12

Single Point button .....4-12

Single-Position Thermostatted Cell Holder  
.....12-15

Slit Sets area .....4-14

slit size .....5-10

slit width .....5-7, 5-11, 7-1-2, 7-5, 11-2

slits 2-3-4, 3-5, 3-11, 4-25-26, 5-4, 5-11, 6-9,  
6-12, 7-1, 7-8, 10-20

small-volume samples .....5-2

Smooth window .....5-12

Smooth .....5-12

smoothing .....5-7, 5-12-13

softkey device .....1-8

Solid Sample Holder .....5-2, 5-4, 7-2, 12-17

solid samples .....5-2-3

SPC Data... .....4-6

\* . SPC file .....4-6

special buttons .....4-1

Spectra button .....3-4, 3-10, 4-23, 4-25

SpectrAcq firmware version .....7-11

Standard .....4-13

standard lamp .....8-2-3

Standard Lamp Accessory .....8-2

Start button .....4-22

Status column .....1-10

stdlamp .....8-7

stdlamp2 .....8-3-4

steady-state layout .....7-1

stirring bar .....7-2

Stopped-flow accessory .....12-27

Subtract Dark .....10-8, 10-11

Switch menu between HJY Software  
Application and Origin Std. button...4-19

synchronous scan .....4-2

surface requirements .....1-2

system configuration .....7-10, 8-8

System Configuration .....5-15, 8-10

System Configuration area .....4-21

System Configuration window 5-15, 8-10

System Initialization Process window 1-  
10

System ReInitialization .....8-12

---

**T**

TbCl<sub>3</sub> .....9-5, 9-7

TCSPC .....11-3, 12-28

TCSPC upgrade .....12-28

Teflon<sup>®</sup> .....12-3-4, 12-17, 12-19

temperature bath ..1-4, 3-2, 4-2, 12-11, 12-13,  
12-15, 12-29

temperature ramps .....4-1, 4-20

T-format .....10-3

thin films .....5-2, 12-17-18

Time / Accessories tab .....4-21

Time area .....4-21

Time per flash .....9-4, 9-8

toolbar... 3-4, 3-10, 4-4, 4-15, 4-20, 5-5, 5-12,  
5-15, 7-9, 8-10, 8-12

Total Repeats field .....4-10

Training .....0-9, 1-1

Transmission Accessory .....12-30

transmittance .....12-30

trigger accessory .....1-7

trigger cable .....1-7, 6-2, 12-31

TRIGGER connector .....1-7, 12-31

troubleshooting .....7-1, 10-19

turning on the system .....3-2

Type column .....4-13

---

**U**

ultraviolet light notice .....0-5, 0-8

units .....3-5, 3-11

Unknown .....4-13

unknown sample .....4-23

unpacking and installation .....1-5

Up button .....4-9

USB cable .....1-6-8

USB port .....6-13

Utilities directory .....6-13

---

**V**

View System Info button .....7-10

vs SinglePoint .....5-5, 10-16

---

**W**

warning notice .....0-5

water-Raman scan 3-11–12, 6-1, 6-8, 6-10, 7-6-9, 10-18–20, 11-2  
 Wavelength Sets area..... 4-14  
 WEEE ..... 0-14  
 Window increment..... 9-9  
 Windows<sup>®</sup> .. 0-1, 1-7, 2-6, 3-2, 4-1, 7-3, 11-4, 12-32  
 Windows<sup>®</sup> Explorer ..... 6-13

---

## X

xcorrect .... 5-14, 5-16, 5-18–19, 8-1, 8-10  
 xenon flash lamp ..... 7-3, 11-3  
 xenon lamp 0-9–10, 2-2, 2-5–6, 3-1, 3-4, 6-1–2, 6-5, 6-7–9, 6-11, 7-2, 8-5, 11-2, 12-20  
 xenon-lamp bulb ..... 1-1  
 xenon-lamp scan 3-4–5, 3-10, 6-1, 6-8, 7-4–5, 7-9, 10-18–20  
 .xml file..... 4-9

---

## Z

Zip Info button ..... 7-10  
 Z-Value field ..... 4-7

# **HORIBA**

## **Scientific**

3880 Park Avenue, Edison, New Jersey 08820-3012, USA  
[www.horiba.com/scientific](http://www.horiba.com/scientific)

---

[Design Concept]

The HORIBA Group application images are collaged in the overall design.  
Beginning from a nano size element, the scale of the story develops all the way to the Earth with a gentle flow of the water.

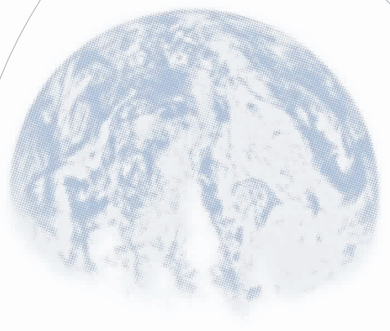

Explore the future

Automotive Test Systems | Process & Environmental | Medical | Semiconductor | Scientific

**HORIBA**